

Monumental Entrances

Designed to withstand heavy use in high-traffic areas, Tubelite's Monumental Doors feature a section depth of 2" and minimum wall thickness of 3/16", increased at critical points to 1/4" for added strength. Available in Narrow Stile 3", Medium Stile 4-1/2" and Wide Stile 6" models; top rails in 3-1/2", 4-1/2" and 6" heights; and bottom rails in 6" or optional 10" heights for ADA compliance. Sight lines complement the bold features of institutional applications and heavy-duty hardware. Framing may be reinforced with steel and used with a continuous hinge for maximum strength and dependability.

Durable Tie-Rod Construction

The strength and flexibility of steel tie-rod construction is what holds it all together and makes our doors endure. Tie-rod assembly is as durable as welded corner construction, but superior in many ways. Monumental doors can be modified, disassembled or resized right in the field. No other door offers you this much strength and flexibility.



**400 Series
Curtainwall**

**14000 Series
Storefront**

ALSO
USED
WITH

TUBELITE[®]
DEPENDABLE

LEADERS IN ECO-EFFICIENT STOREFRONT,
CURTAINWALL AND ENTRANCE SYSTEMS

Sandy Commerce Park, Sandy, UT
Photographer: Robert Casey

Monumental Entrances

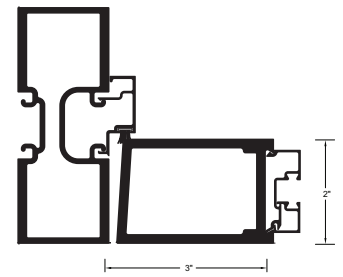
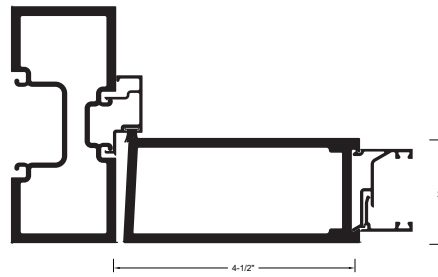
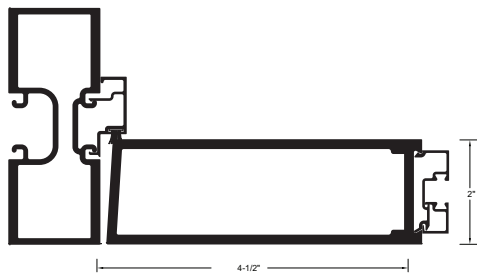

System Features:

- Narrow Stile 3" (76.2mm), Medium Stile 4-1/2" (114.3mm), Wide Stile 6" (152.4mm) sight line on verticals and top rail
- Minimum wall thickness of 3/16", increased at critical points to 1/4" for added strength
- Deadbolt Lock
- 1" dia. Push bar and Offset Pull Handle
- Standard infill options 1" (25.4mm), and 1/4" (6.35mm), other infills available
- 3'0" and 3'6" width single doors, 6"0" width pairs of doors
- 7'0" height door leaves



Optional Features:

- 6" (152.4mm) and 10" (254mm) bottom rails
- Mortised Butt Hinges and Continuous Hinges
- Latch Locks, CVR & Rim Panics, Electric Strikes
- Hardware by Others
- 1-3/4" or 2" x 4-1/2" sight-line frame member
- Intermediate Horizontal or Vertical Mid-rails
- A wide variety of standard anodized and painted colors are available to complement any project with warranted protection, as well as street appeal.
- Custom height and width doors

Note: Dimensions do not include 1/2" glass stops.

Standard Entrance Series	Narrow Stile	Medium Stile	Wide Stile
Traffic	Heavy	Heavy	Heavy
Vertical Stile 2" x	3"	4-1/2"	6"
Top Rail 2" x	3-1/3"	4-1/2"	6"
Bottom Rail 2" x	6" (opt. up to 10")	6" (opt. up to 10")	6" (opt. up to 10")
Maximum Sizes	Single: 4'0" x 9'0" Pair: 8'0" x 9'0"	Single: 4'0" x 9'0" Pair: 8'0" x 9'0"	Single: 4'0" x 9'0" Pair: 8'0" x 9'0"

Monumental Entrance Series Product Specifications

Application: Schools, Universities, Hospitals, Offices

Description: Narrow Stile 3", Medium Stile 4-1/2" and Wide Stile 6" models; top rails in 3-1/2", 4-1/2" and 6" heights; and bottom rails in 6" or optional 10" heights for ADA compliance

Glass:	Air Infiltration:	Structural:	U-Factor** Single Door:	U-Factor** Double Door:
1" std (1/8" - 1")	1.0 CFM / Ft.2 @ 1.57 PSF	30 PSF - Design 45 PSF - Overload	Narrow: 0.70 Medium: 0.76 Wide: 0.81	Narrow: 0.65 Medium: 0.71 Wide: 0.76

** U-Factor per NFRC 100: COG = 0.24 with warm edge spacer, 1-3/4" x 4-1/2" non-thermal frame.

Refer to the U-Factor table at: www.tubeliteinc.com/products/entrances/monumental-entrances/ for other glass makeups and configurations.

DISCLAIMER: Tubelite takes no responsibility for product selection or application, including, but not limited to, compliance with building codes, safety codes, laws, merchantability or fitness for a particular purpose; and further disclaims all liability for the use, in whole or in part, of this Technical Guide in preparation of project specifications and/or other documents. Technical Guides are subject to change at any time, without notice, and at Tubelite's sole discretion. ©2017 Tubelite Inc.

112320

TUBELITE®

DEPENDABLE

LEADERS IN ECO-EFFICIENT STOREFRONT,
CURTAINWALL AND ENTRANCE SYSTEMS

MONUMENTAL ENTRANCES

Tubelite reserves the right to change system configuration without prior notice when deemed necessary for product improvements.

Laws and building & safety codes governing the design and use of glazed entrance, window and curtain wall systems vary widely. Tubelite does not control the selection of product configurations, operating hardware or glazing materials, and assumes no responsibility thereof.

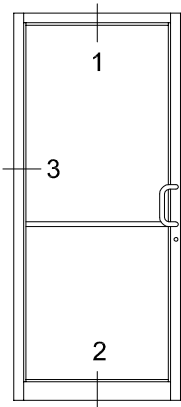

Narrow Stile

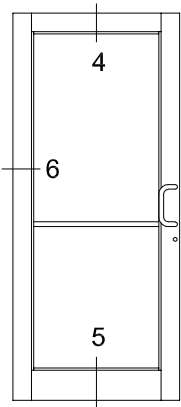

Medium Stile

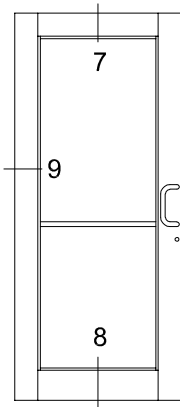

Wide Stile

Standard Details

1/4 scale

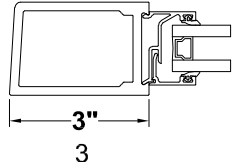

3

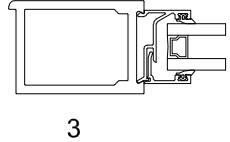

3

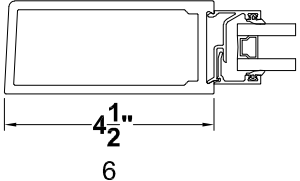

6

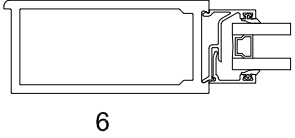

6

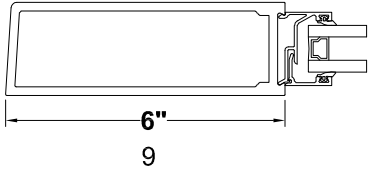

9

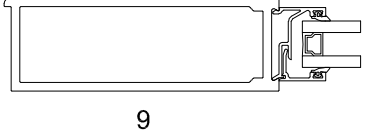

9

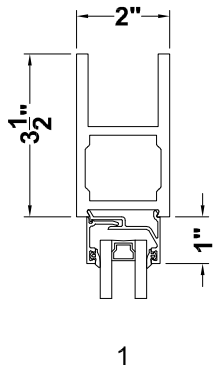

1

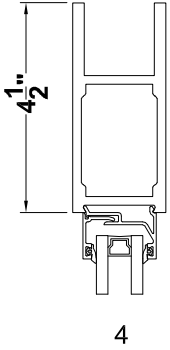

4

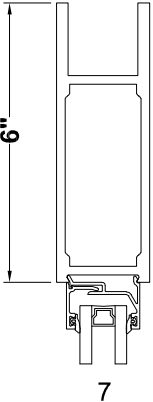

7

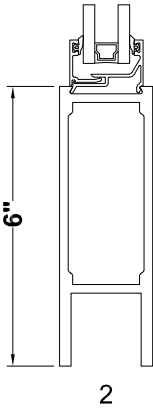

2

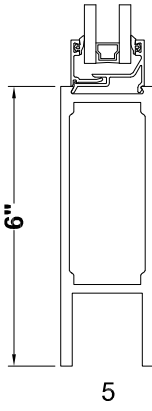

5

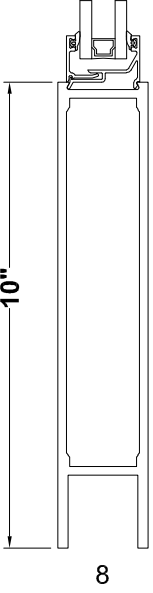

8

TUBELITE[®]
DEPENDABLE
LEADERS IN ECO-EFFICIENT STOREFRONT,
CURTAINWALL AND ENTRANCE SYSTEMS

February 2020

For specific product applications, contact your Tubelite representative.
Details on this page represent standard details found on our website.
For more options, visit our website at www.tubeliteinc.com/monumental-doors/

MONUMENTAL ENTRANCES

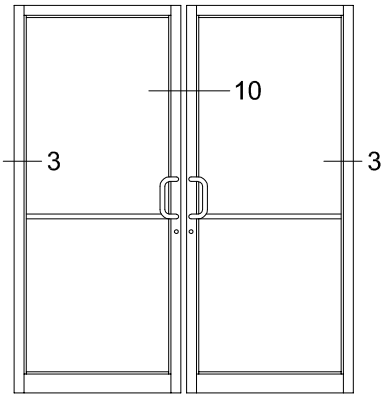

Narrow Stile

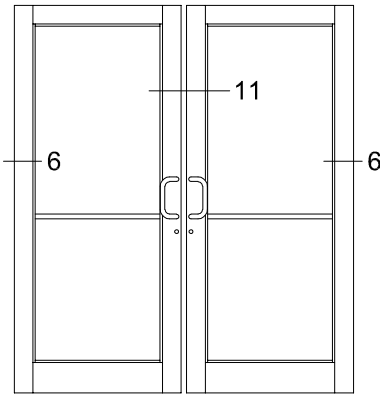

Medium Stile

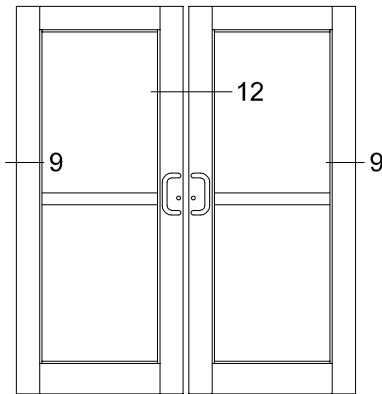

Wide Stile

Tubelite reserves the right to change system configuration without prior notice when deemed necessary for product improvements.

Laws and building & safety codes governing the design and use of glazed entrance, window and curtain wall systems vary widely. Tubelite does not control the selection of product configurations, operating hardware or glazing materials, and assumes no responsibility thereof.

Standard Details

1/4 scale

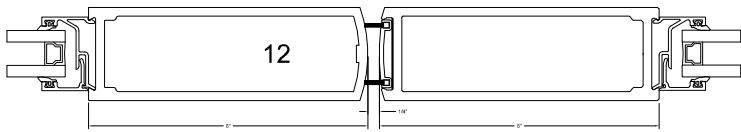
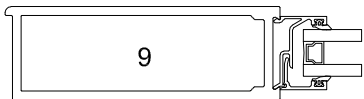
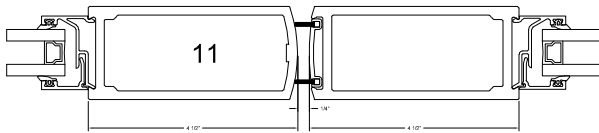
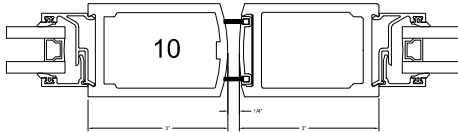
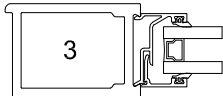

February 2020

For specific product applications, contact your Tubelite representative.
 Details on this page represent standard details found on our website.
 For more options, visit our website at www.tubeliteinc.com/monumental-doors/

MONUMENTAL ENTRANCES

Tubelite reserves the right to change system configuration without prior notice when deemed necessary for product improvements.

Laws and building & safety codes governing the design and use of glazed entrance, window and curtain wall systems vary widely. Tubelite does not control the selection of product configurations, operating hardware or glazing materials, and assumes no responsibility thereof.

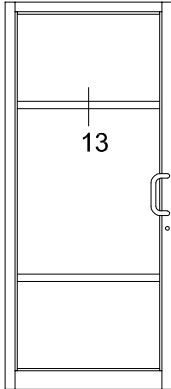

Standard Details
1/4 scale

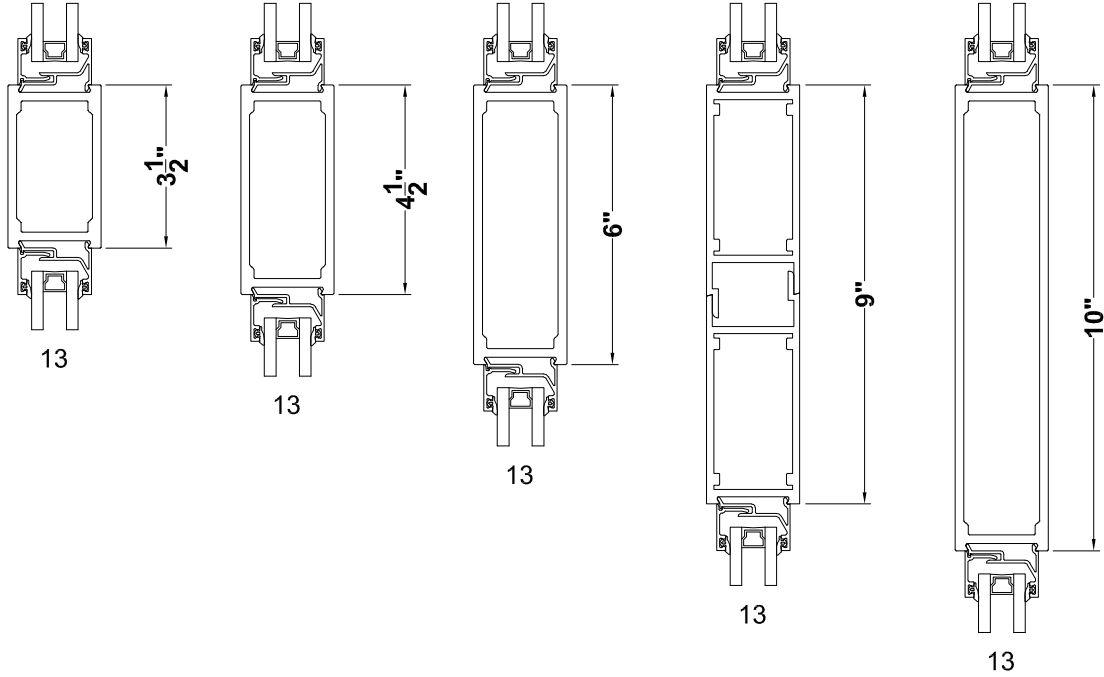

February 2020

TUBELITE®
DEPENDABLE
LEADERS IN ECO-EFFICIENT STOREFRONT,
CURTAINWALL AND ENTRANCE SYSTEMS

For specific product applications, contact your Tubelite representative.
Details on this page represent standard details found on our website.
For more options, visit our website at www.tubeliteinc.com/monumental-doors/

MONUMENTAL ENTRANCES

Tubelite reserves the right to change system configuration without prior notice when deemed necessary for product improvements.

Laws and building & safety codes governing the design and use of glazed entrance, window and curtain wall systems vary widely. Tubelite does not control the selection of product configurations, operating hardware or glazing materials, and assumes no responsibility thereof.

Optional Details
1/4 scale

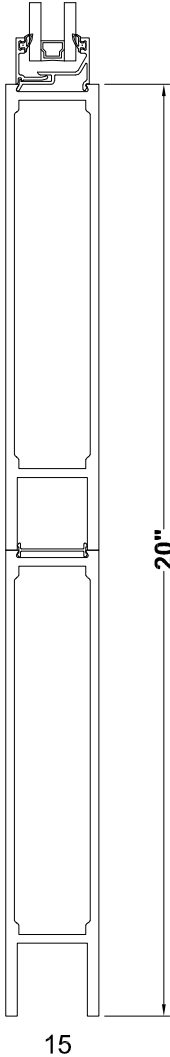
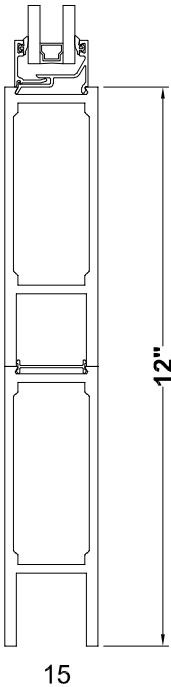
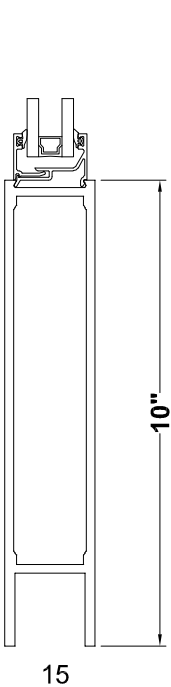
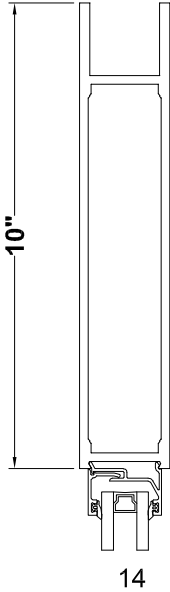
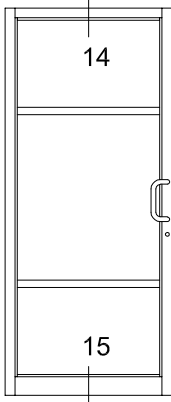

February 2020

For specific product applications, contact your Tubelite representative.
Details on this page represent standard details found on our website.
For more options, visit our website at www.tubeliteinc.com/monumental-doors/