

AAMA 507-07 THERMAL PERFORMANCE REPORT

Rendered to:

TUBELITE, INC.

SERIES/MODEL: Monumental Wide Stile Single Door

TYPE: Swinging Door - Single

Report No: B3772.12-116-45
Report Date: 10/27/11

AAMA 507-07 THERMAL PERFORMANCE REPORT

Rendered to:

TUBELITE, INC.
4878 Mackinaw Trail
Reed City, Michigan 49677

Report No: B3772.12-116-45
Report Date: 10/27/11
Simulation Date: 10/27/11

Project Summary:

Architectural Testing, Inc. was contracted by Tubelite, Inc. to provide U-Factor and Solar Heat Gain Coefficient thermal performance ratings on the Monumental Wide Stile Single Door Swinging Door - Single. The thermal performance ratings were determined in accordance with AAMA 507-07, Standard Practice for Determining the Thermal Performance Characteristics of Fenestration Systems Installed in Commercial Building.

Reference Documents:

AAMA 507-07, Standard Practice for Determining the Thermal Performance Characteristics of Fenestration Systems Installed in Commercial Buildings

NFRC 100-2010, Procedure for Determining Fenestration Product U-Factors

NFRC 200-2010, Procedure for Determining Fenestration Product Solar Heat Gain Coefficient and Visible Transmittance at Normal Incidence

Simulation Specimen Description:

Series/Model:	Monumental Wide Stile Single Door
Product Groupings:	Mon. Wide w/o sweep grouped with Mon. Wide w/ sweep.
Type:	Swinging Door - Single
Frame Material:	Aluminum Framing System
Material Finish:	Painted Aluminum
Specimen Size:	960mm wide by 2090mm high (37-3/4" by 82-3/8")
Configuration:	Single vision lite
Drawing Reference:	Tubelite Standard Doors - Monumental Frame Details

Tubelite, Inc.
Monumental Wide Stile Single Door - Swinging Door - Single

System U-Factor vs. Percentage of Vision Area

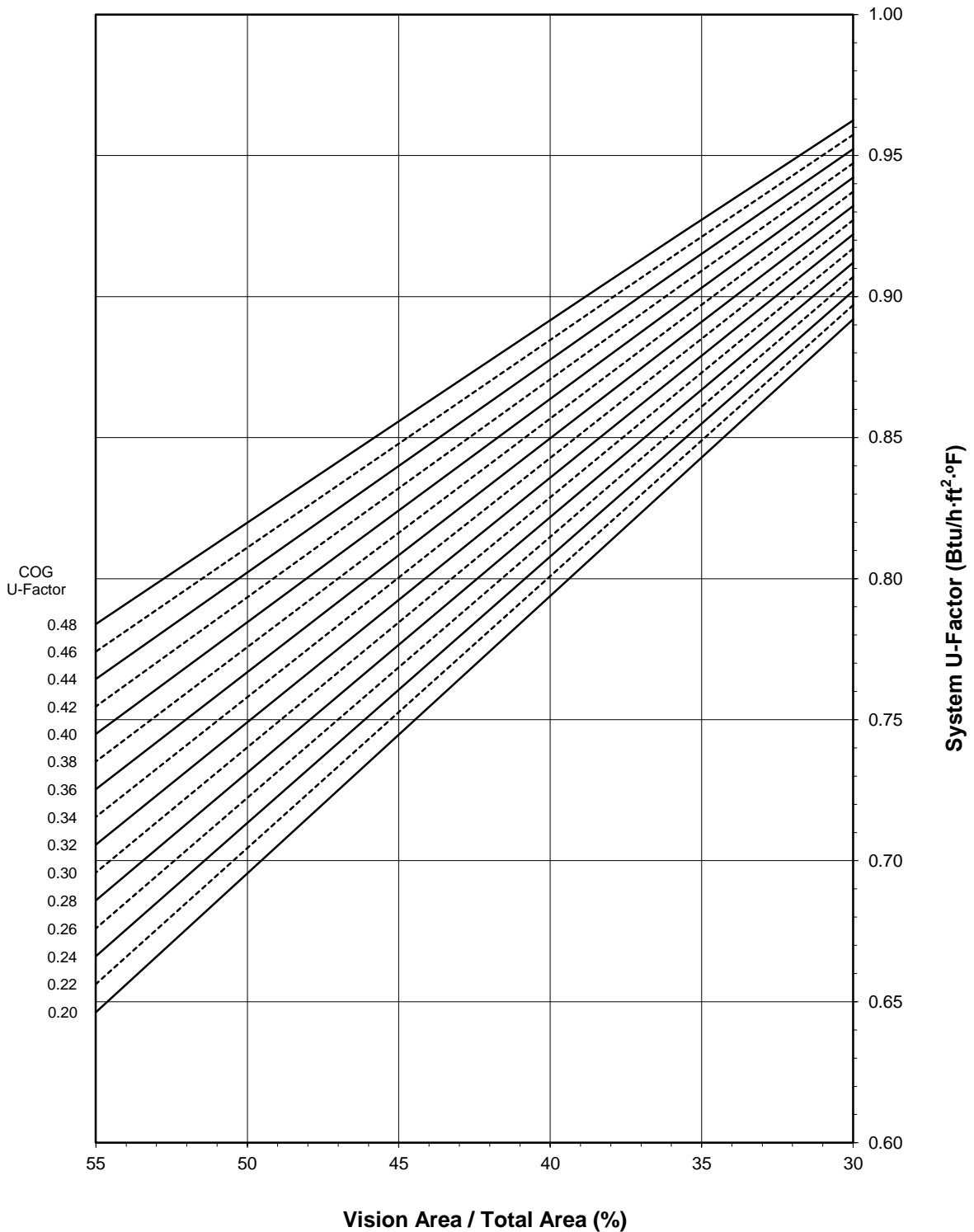

Note: 1 inch Overall - Dual Glazed Glass (0.48-0.20 COG) with Aluminum Spacer

Tubelite, Inc.
Monumental Wide Stile Single Door - Swinging Door - Single

Size Specific U-Factor Matrix*

Glazing Option	Center of Glass U-Factor	Overall U-Factor
1	0.48	0.90
2	0.46	0.90
3	0.44	0.89
4	0.42	0.88
5	0.40	0.88
6	0.38	0.87
7	0.36	0.86
8	0.34	0.86
9	0.32	0.85
10	0.30	0.84
11	0.28	0.84
12	0.26	0.83
13	0.24	0.82
14	0.22	0.82
15	0.20	0.81

Note: 1 inch Overall - Dual Glazed Glass (0.48-0.20 COG) with Aluminum Spacer

Size Specific SHGC Matrix*

Center of Glass SHGC	Overall SHGC
0.75	0.46
0.70	0.43
0.65	0.40
0.60	0.37
0.55	0.35
0.50	0.32
0.45	0.29
0.40	0.26
0.35	0.24
0.30	0.21
0.25	0.18
0.20	0.15
0.15	0.12
0.10	0.10
0.05	0.07

Size Specific VT Matrix*

Center of Glass VT	Overall VT
0.75	0.42
0.70	0.39
0.65	0.36
0.60	0.33
0.55	0.31
0.50	0.28
0.45	0.25
0.40	0.22
0.35	0.19
0.30	0.17
0.25	0.14
0.20	0.11
0.15	0.08
0.10	0.06
0.05	0.03

*Size Specific U-Factor, SHGC, and VT Matrices are based on the standard Swinging Door - Single specimen size of 960mm wide by 2090mm high (37-3/4" by 82-3/8"). This represents 38.4% Vision Area / Total Area.

Vision Area Data

Option No.	COG U-Factor	COG Temperature	Cross Section	Frame Height	Frame U-Factor	Edge U-Factor	Total Product U-Factor		
							30% Vision Area	NFRC 100-2010	55% Vision Area
							31.72" by 72.06"	37.80" by 82.28"	54.26" by 123.26"
1	0.48	43.7	Head	9.2163	1.1725	0.5777	0.9625	0.9028	0.7839
			L. Jamb	9.1458	1.1653	0.5789			
			R. Jamb	9.1458	1.1653	0.5789			
			Sill	11.7790	1.0879	0.5796			
2	0.46	44.8	Head	9.2163	1.1724	0.5641	0.9574	0.8961	0.7742
			L. Jamb	9.1458	1.1653	0.5653			
			R. Jamb	9.1458	1.1653	0.5653			
			Sill	11.7790	1.0878	0.5659			
3	0.44	45.8	Head	9.2163	1.1723	0.5506	0.9523	0.8894	0.7645
			L. Jamb	9.1458	1.1652	0.5518			
			R. Jamb	9.1458	1.1652	0.5518			
			Sill	11.7790	1.0877	0.5523			
4	0.42	46.8	Head	9.2163	1.1723	0.5372	0.9472	0.8828	0.7547
			L. Jamb	9.1458	1.1651	0.5384			
			R. Jamb	9.1458	1.1651	0.5384			
			Sill	11.7790	1.0876	0.5389			
5	0.40	47.9	Head	9.2163	1.1722	0.5238	0.9422	0.8761	0.7450
			L. Jamb	9.1458	1.1651	0.5251			
			R. Jamb	9.1458	1.1651	0.5251			
			Sill	11.7790	1.0875	0.5254			
6	0.38	48.9	Head	9.2163	1.1722	0.5106	0.9372	0.8694	0.7352
			L. Jamb	9.1458	1.1650	0.5119			
			R. Jamb	9.1458	1.1650	0.5119			
			Sill	11.7790	1.0874	0.5122			
7	0.36	50.0	Head	9.2163	1.1721	0.4974	0.9321	0.8627	0.7254
			L. Jamb	9.1458	1.1650	0.4986			
			R. Jamb	9.1458	1.1650	0.4986			
			Sill	11.7790	1.0874	0.4989			
8	0.34	51.0	Head	9.2163	1.1721	0.4844	0.9271	0.8561	0.7156
			L. Jamb	9.1458	1.1649	0.4856			
			R. Jamb	9.1458	1.1649	0.4856			
			Sill	11.7790	1.0873	0.4858			
9	0.32	52.0	Head	9.2163	1.1720	0.4712	0.9221	0.8494	0.7057
			L. Jamb	9.1458	1.1649	0.4724			
			R. Jamb	9.1458	1.1649	0.4724			
			Sill	11.7790	1.0872	0.4726			
10	0.30	53.1	Head	9.2163	1.1720	0.4583	0.9170	0.8427	0.6959
			L. Jamb	9.1458	1.1649	0.4595			
			R. Jamb	9.1458	1.1649	0.4595			
			Sill	11.7790	1.0871	0.4596			

Vision Area Data

Option No.	COG U-Factor	COG Temperature	Cross Section	Frame Height	Frame U-Factor	Edge U-Factor	Total Product U-Factor		
							30% Vision Area	NFRC 100-2010	55% Vision Area
							31.72" by 72.06"	37.80" by 82.28"	54.26" by 123.26"
11	0.28	54.2	Head	9.2163	1.1720	0.4453	0.9120	0.8360	0.6860
			L. Jamb	9.1458	1.1648	0.4465			
			R. Jamb	9.1458	1.1648	0.4465			
			Sill	11.7790	1.0870	0.4465			
12	0.26	55.2	Head	9.2163	1.1719	0.4324	0.9070	0.8293	0.6761
			L. Jamb	9.1458	1.1648	0.4336			
			R. Jamb	9.1458	1.1648	0.4336			
			Sill	11.7790	1.0870	0.4336			
13	0.24	56.3	Head	9.2163	1.1719	0.4195	0.9020	0.8226	0.6662
			L. Jamb	9.1458	1.1647	0.4207			
			R. Jamb	9.1458	1.1647	0.4207			
			Sill	11.7790	1.0869	0.4207			
14	0.22	57.3	Head	9.2163	1.1719	0.4067	0.8970	0.8159	0.6563
			L. Jamb	9.1458	1.1647	0.4080			
			R. Jamb	9.1458	1.1647	0.4080			
			Sill	11.7790	1.0868	0.4081			
15	0.20	58.4	Head	9.2163	1.1718	0.3939	0.8919	0.8092	0.6463
			L. Jamb	9.1458	1.1647	0.3951			
			R. Jamb	9.1458	1.1647	0.3951			
			Sill	11.7790	1.0868	0.3952			

Detailed drawings, datasheets, representative samples of test specimens, a copy of this report, or other pertinent project documentation will be retained by Architectural Testing, Inc. for a period of four years from the original test date. At the end of this retention period such materials shall be discarded without notice and the service life of this report by Architectural Testing will expire. Results obtained are simulated values and were secured by using the designated test methods. This report does not constitute certification of this product nor an opinion or endorsement by this laboratory. It is the exclusive property of the client named herein and relates only to the specimen(s) simulated. This report may not be reproduced, except in full, without the written approval of Architectural Testing, Inc.

For ARCHITECTURAL TESTING, INC.:

SIMULATED BY:

REVIEWED BY:

Eric Barilar
Simulation Technician

Kevin S. Louder
Project Engineer

EAB:EAB
B3772.12-116-45

Attachments (pages): This report is complete only when all attachments listed are included.

Appendix A: Drawings and Bills of Material (23)

Revision Log

<u>Rev. #</u>	<u>Date</u>	<u>Page(s)</u>	<u>Revision(s)</u>
.01R0	10/27/2011	All	Original Report Issue

All drawings and Bills of Material used in simulating this product are enclosed in this Appendi

MONUMENTAL SINGLE DOOR BOM

ATI

Report # B3772-116-45

Date 10/20/2011

Simulator *Eric Barilko*

FRAME:

Description	QTY	Part number	Material
Monumental Jamb 2" x 4 1/2"	2	E14121	
Header 2" x 4 1/2"	1	E14124	
Screws for frame clip		S009	AL
screws for header to clip		S070	
Door stops	3	E2942	
Weather pile	30 ft	P1098A	Vinyl

DOOR:

Description	QTY	Narrow P/N	Medium P/N	Wide P/N	Material
Beveled Door Stiles	2	E1047 - 3"	E1397 - 4 1/2"	E2937 - 6"	
Door Top Rail	1	E1050 - 3 1/2"	E3029 - 4/ 1/2"	E1051 - 6"	
Top Rail Lug	2	P907	P1649	P908	
Door Botom Rail	1	E1051 - 6"	E1051 - 6"	E2954 - 10"	
Bottom Rail Lug	2	P908	P908	P1648	
Top Rail & Bottom Rail Tie Rods	2	P020	P020	P020	
Washer for Tie Rods	4	P853	P853	P853	
Hex nuts for Tie rods	4	S071A	S071A	S071A	
Exterior Glass Stop 1" glass	4	E0927	E0927	E0927	
Interior Glass Stop 1" glass	4	E0928	E0928	E0928	
Gasket	36 ft	P0017	P0017	P0017	
Adjustable Wedge Setting Bkck	2	P1911	P1911	P1911	Polypropylene
Self Adhesive Setting Bkck	3	P1912	P1912	P1912	EPDM
Threshold	1	E0019	E0019	E0019	
Threshold clip	2	P679	P679	P679	AL

MATERIAL:

E - All E part numbers are AL extrusions

Monumental Doors - Single Jamb detail

Elevations & 1/4 Size Details

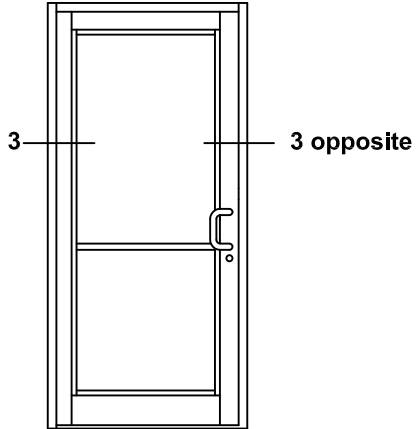

	ATI
Report #	<u>B3772-116-45</u>
Date	<u>10/20/2011</u>
Simulator	<u>Eric Borillo</u>

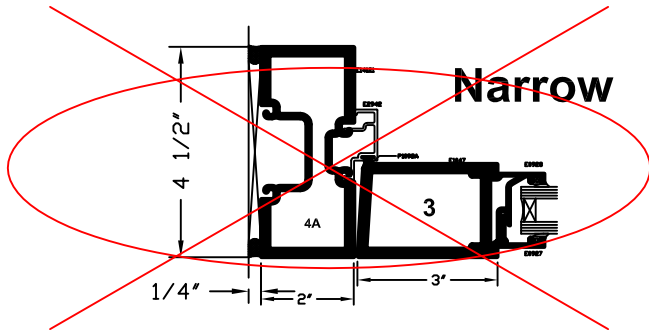
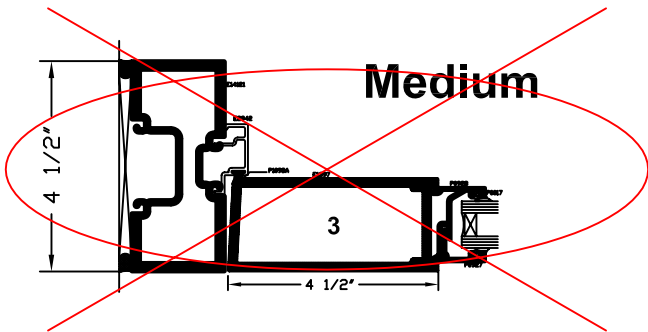
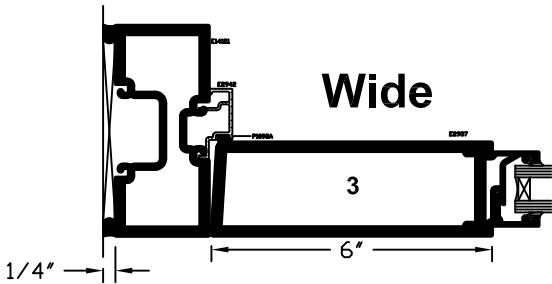

TUBELITE®

DEPENDABLE

LEADERS IN ECO-EFFICIENT STOREFRONT,
CURTAINWALL AND ENTRANCE SYSTEMS

2011

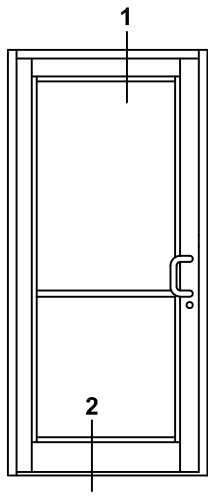

Monumental Doors - Single Elevations & 1/4 Size Details

ATI	
Report #	<u>B3772-116-45</u>
Date	<u>10/20/2011</u>
Simulator	<u><i>Eric Barthe</i></u>

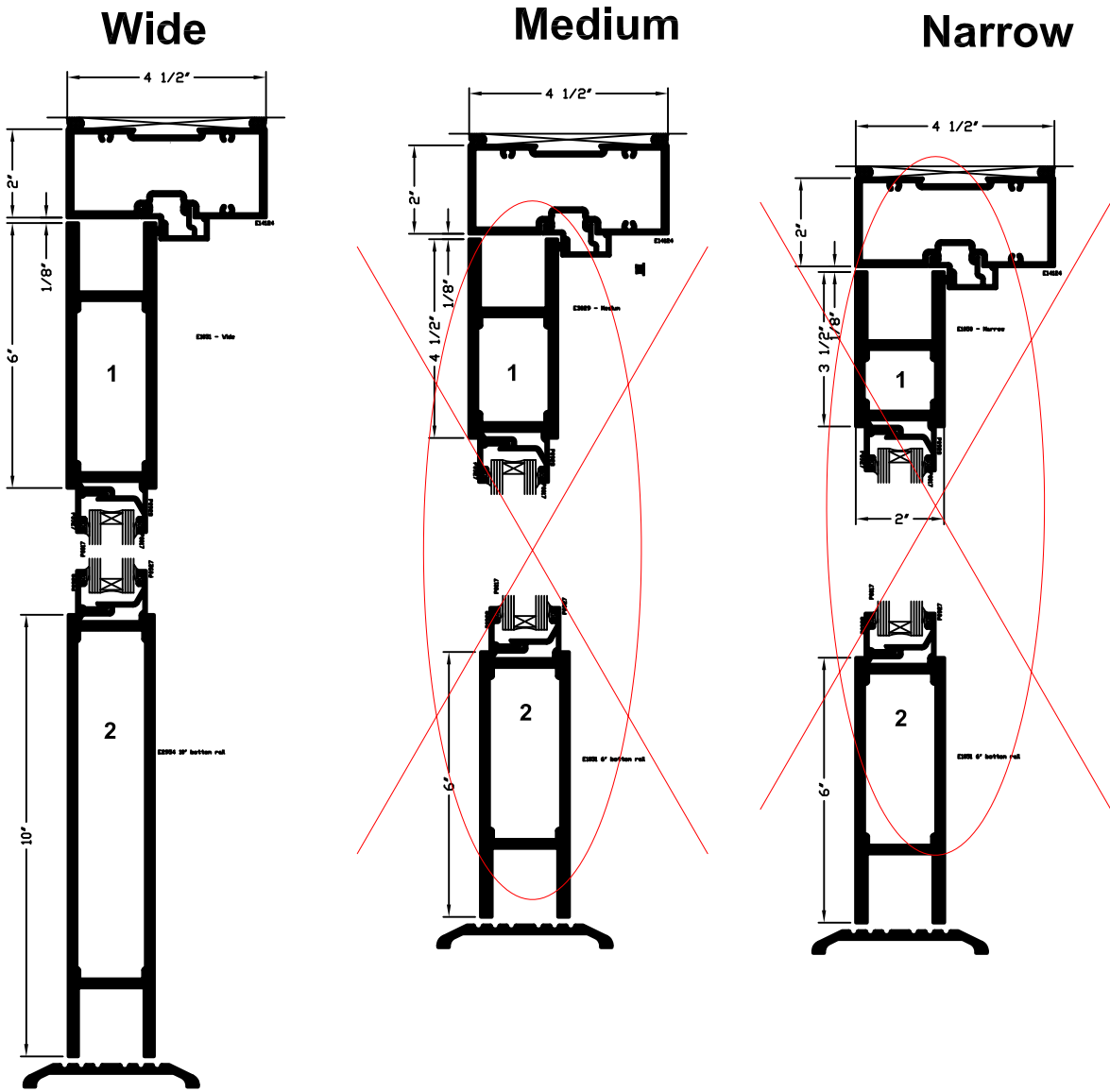

*SEALANT, ROD, & ANCHORS NOT BY TUBELITE

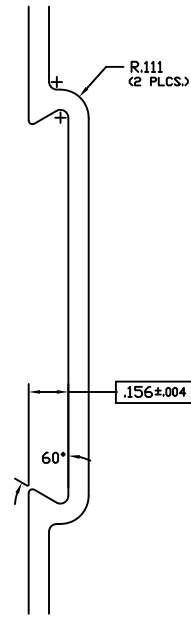

TWO TIMES SIZE

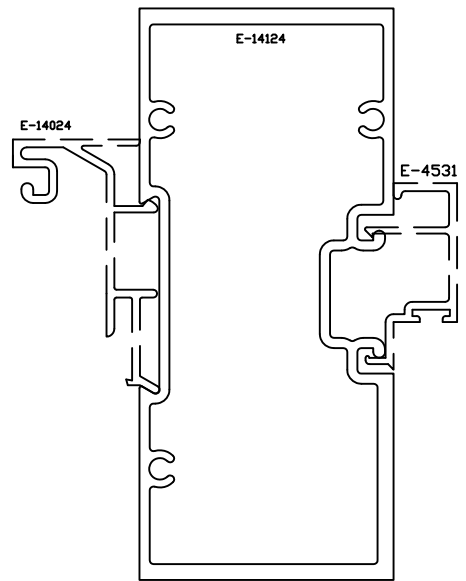

ASSEMBLY

MATES W/ E-4532, E-4026 & E-14024

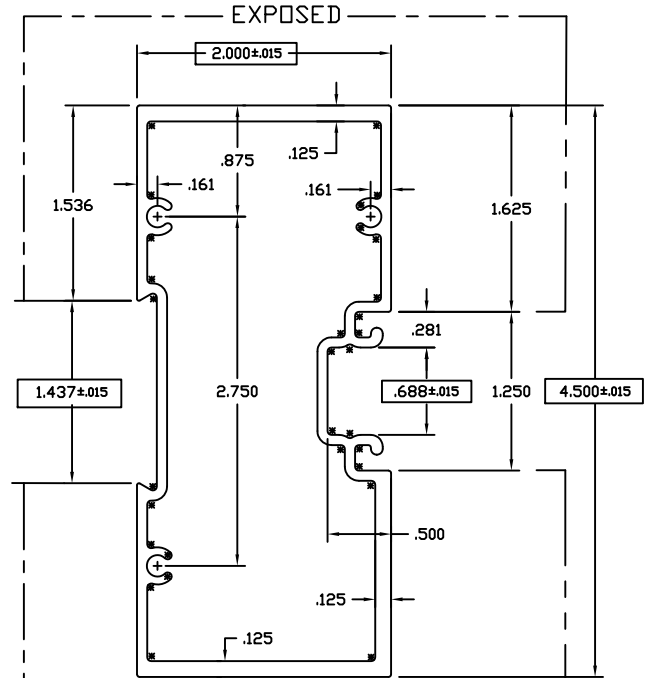

EXPOSED
ACTUAL SIZE

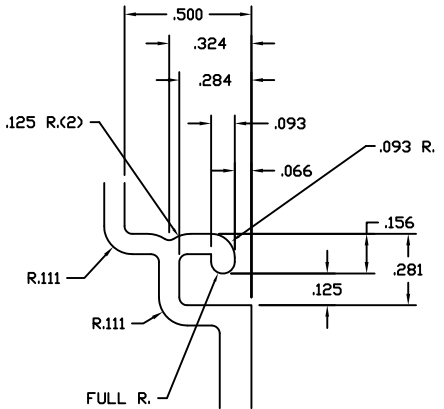

TWO TIMES SIZE

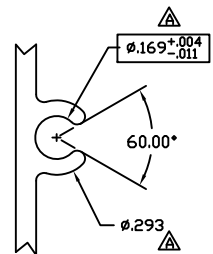

TWO TIMES SIZE

ATI
 Report # B3772-116-45
 Date 10/20/2011
 Simulator Eric Boriska

©2006 TUBELITE INC. ALL RIGHTS RESERVED
 ALUMINUM ASSOCIATION STANDARD
 TOLERANCES APPLY UNLESS NOTED
 ALL UNSPECIFIED RADII .015
 * INDICATES .031 RADIUS
 DENOTES CRITICAL DIMENSION
 ALL DIES PROPERTY OF TUBELITE

TUBELITE
 LEADING IN ECO-FRIENDLY OPERATING
 CURTAINWALL AND ENTRANCE SYSTEMS

3056 WALKER RIDGE NW, SUITE G
 WALKER, MICHIGAN 49544

WALL THK.	.080	SECTION H		MAT'L	6063-T5	RATIO	38:1
PERIMETER OUT (TOTAL)	15.371(29.969)		AREA	1.464	WGT/FT	1.722	
FACTOR	17	CIRCLE SIZE	4.924	INFILL VOLUME	N/A		
RXX	1.601	SXX	1.640	IXX	3.751	CXX	2.287
RYY	.780	SYY	.849	IYY	.890	CYY	1.049

DOOR HEADER 2" X 4 1/2"
 E14000 NON THERMAL STOREFRONT

DRAWN BY	SMH	DRWG DATE	05/11/93	APPV'D BY		DATE APPV'D	
DWG SCALE	NOTED	PRODUCT CODE	190		E14124	REV	A

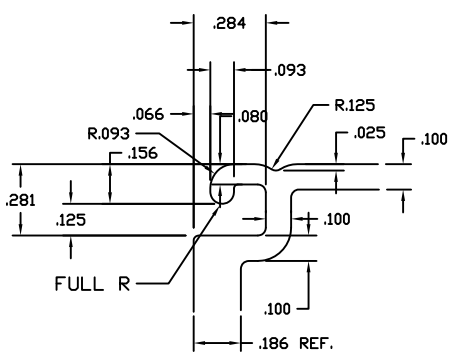

DETAIL "A"
TWO TIMES SCALE

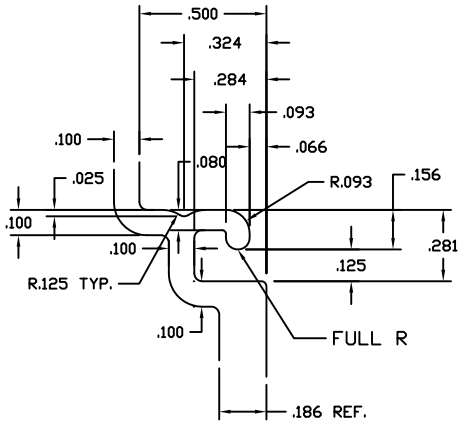

DETAIL "B"
TWO TIMES SCALE

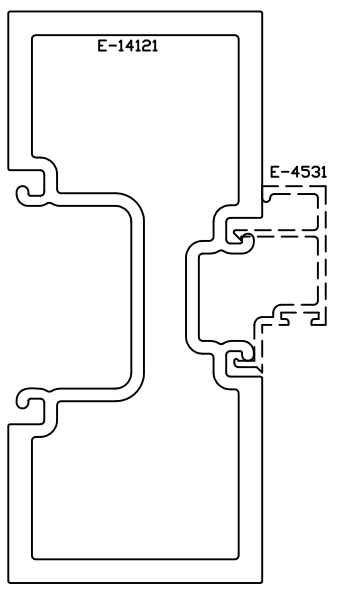

FULL SCALE ASSEMBLY

ALSO MATES W/ E-4013

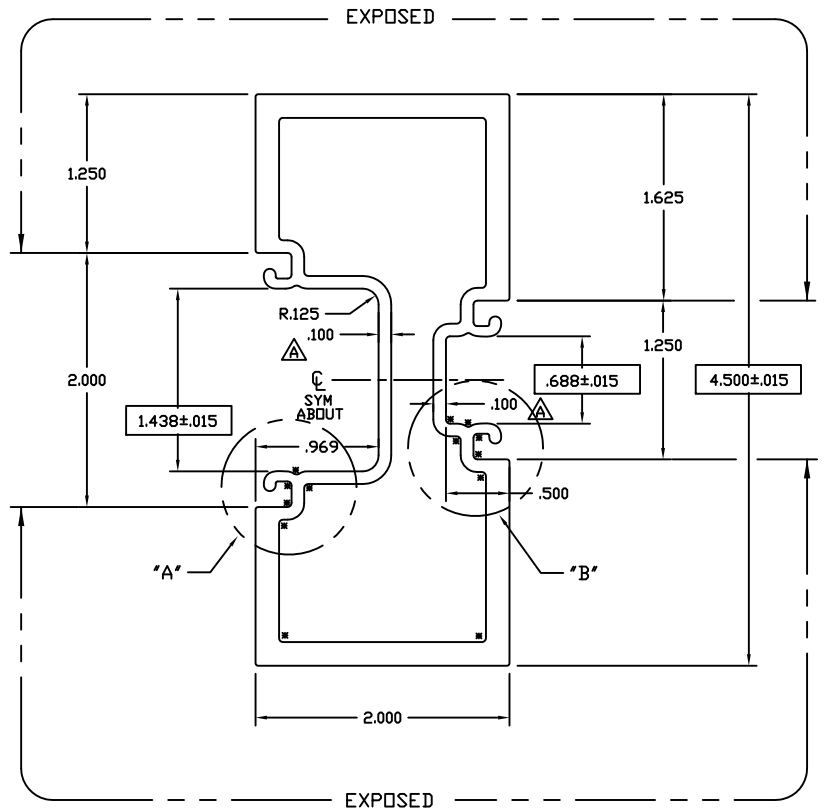

FULL SCALE

ATI

Report # B3772-116-45

Date 10/20/2011

Simulator Eric Borde

©2006 TUBELITE INC. ALL RIGHTS RESERVED
ALUMINUM ASSOCIATION STANDARD
TOLERANCES APPLY UNLESS NOTED

TUBELITE
DEPENDABLE
LEADER IN ECO-FRIENDLY OPERATING
CURTAINWALL AND ENTRANCE SYSTEMS

3056 WALKER RIDGE NW, SUITE G
WALKER, MICHIGAN 49544

WALL THK	.186	SECTION CLASS	H	MAT'L	6063-T5	RATIO	24:1
PERIMETER OUT (TOTAL)	17.706(31.122)		AREA	2.307		WGT/FT	2.713
FACTOR	11	CIRCLE SIZE	4.924	INFILL VOLUME	N/A		

RXX	1.577	SXX	2.549	IXX	5.736	CXX	2.250
RYY	.719	SYY	1.124	IYY	1.192	CYY	1.061

DENOTES CRITICAL DIMENSION
ALL DIES PROPERTY OF TUBELITE

REV	DATE	DESCRIPTION	INTL
EP-2688	8/7/98	RELEASE TO TOOLING	SMF
EP-8647	10/28/98	RELEASE TO PRODUCTION	KRH
A	01/02/03	REVISED POCKET CONFIGURATION AND WALL THICKNESS	CRH

THICK WALL DOOR JAMB 2" X 4 1/2"
E14000 NON THERMAL STOREFRONT

DRAWN BY	SMF	DRWG DATE	08/07/98	APPV'D BY		DATE APPV'D	
DWG SCALE	NOTED	PRODUCT CODE	190	E14121			

E2954

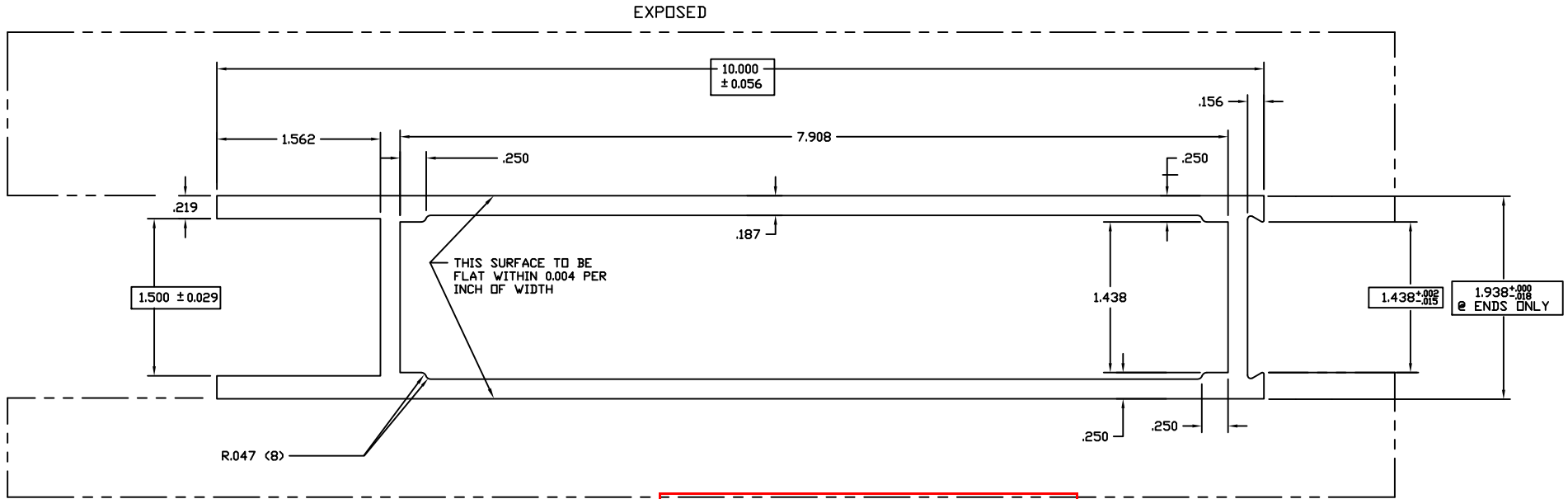

ACTUAL SIZE **ATI**
 Report # B3772-116-45
 Date 10/20/2011
 Simulator Eric Barila

NOTE: FLAT TO CONCAVE
 PURCHASED PART
 .187 TYP WALL UNLESS NOTED

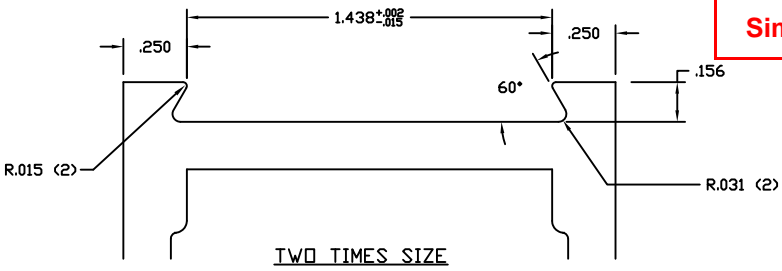

Use with lug P1648

©2006 TUBELITE INC. ALL RIGHTS RESERVED
 ALUMINUM ASSOCIATION STANDARD
 TOLERANCES APPLY UNLESS NOTED
 ALL UNSPECIFIED RADII .015
 * INDICATES .031 RADIUS
 □ DENOTES CRITICAL DIMENSION
 ALL DIES PROPERTY OF TUBELITE

TUBELITE
 LEADING IN ECO-FRIENDLY OPERATING
 CURTAINWALL AND ENTRANCE SYSTEMS

3056 WALKER RIDGE NW, SUITE G
 WALKER, MICHIGAN 49544

WALL THK	NOTED	SECTION CLASS	H	MAT'L	6063-T5	RATIO	13:1
PERIMETER OUT (TOTAL)	27.414	AREA	4.497	WGT/FT	5.289		
FACTOR	6	CIRCLE SIZE	10.186	INFILL VOLUME	N/A		
RXX	3.129	SXX	8.774	IXX	44.029	CXX	4.982
RYX	.830	SYX	3.196	IYX	3.097	CYX	.969

BOTTOM RAIL 10" MONUMENTAL STOCK DOORS

DRWN BY	DM	DRWG DATE	10/25/90	APPV'D BY		DATE APPV'D	
DWG SCALE	NOTED	PRODUCT CODE	100			E2954	

E2942

A

ATI

Report # B3772-116-45

Date 10/20/2011

Simulator Eric Barilko

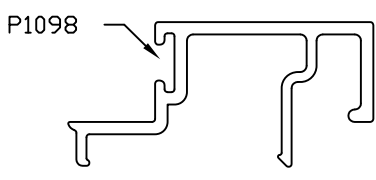

FULL SCALE

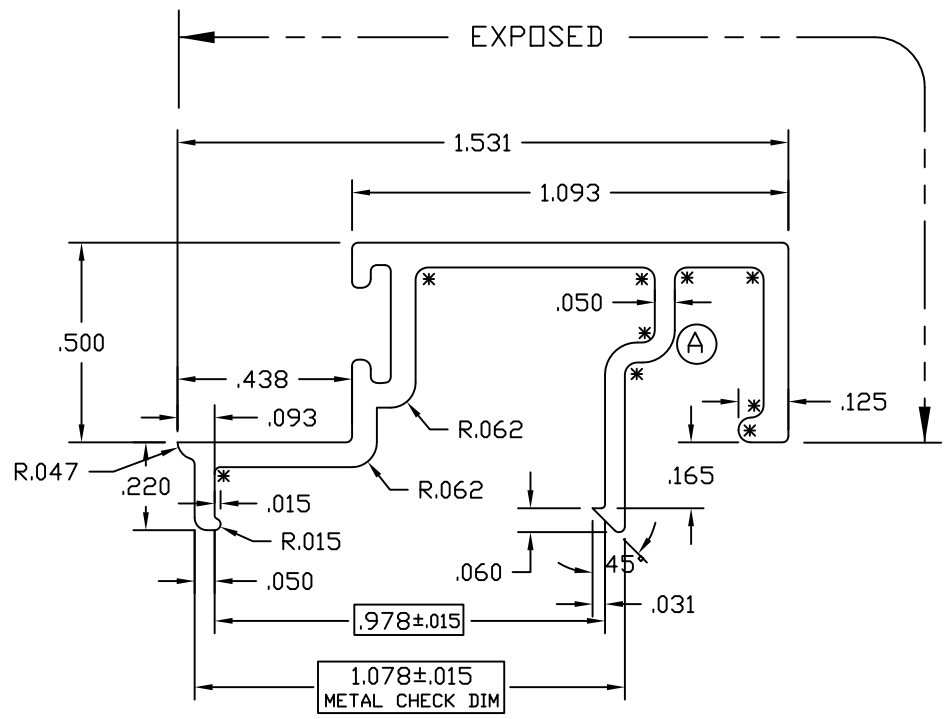

TWO TIMES SCALE

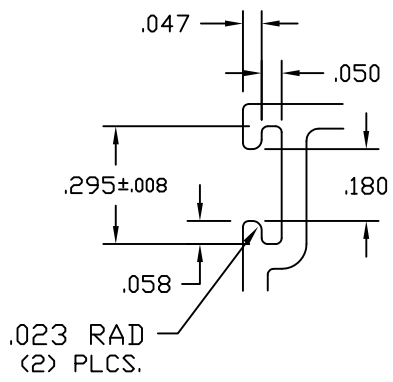

TWO TIMES SCALE

© 2006 TUBELITE INC. ALL RIGHTS RESERVED
 ALUMINUM ASSOCIATION STANDARD
 TOLERANCES APPLY UNLESS NOTED
 ALL UNSPECIFIED RADII .015
 * INDICATES .031 RADIUS

TUBELITE
 DEPENDABLE
 LEADERS IN ECO-EFFICIENT STOREFRONT,
 CURTAINWALL AND ENTRANCE SYSTEMS

3056 WALKER RIDGE NW, SUITE G
 WALKER, MICHIGAN 49544

WALL THK. .062	SECTION CLASS S	MAT'L 6063-T5	RATIO 262:1
PERIMETER OUT (TOTAL) 7.135	AREA .210	WGT/FT .247	
FACTOR 29	CIRCLE SIZE 1.654	INFILL VOLUME N/A	

RXX .217	SXX .037	IXX .010	CXX .455
RYY .456	SYX .066	IYY .044	CYY .868

DOOR STOP 1/2" X 1 3/32"
 CUSTOM DOORS/FRAMES

DRAWN BY DM	DRWG DATE 06/10/90	APPV'D BY	DATE APPV'D
DWG SCALE NOTED	PRODUCT CODE 110	E2942	REV A

REV	DATE	DESCRIPTION	INTL
ED-1229	06/04/90	RELEASED TO TOOLING	DSM
ED-1272	10/02/90	RELEASED TO PRODUCTION	DSM
A	10/02/03	REVISED LEG TO AVOID CONFUSION PER ER120302	DMT

E2937
B

ATI
Report # B3772-116-45
Date 10/20/2011
Simulator Eric Bakula

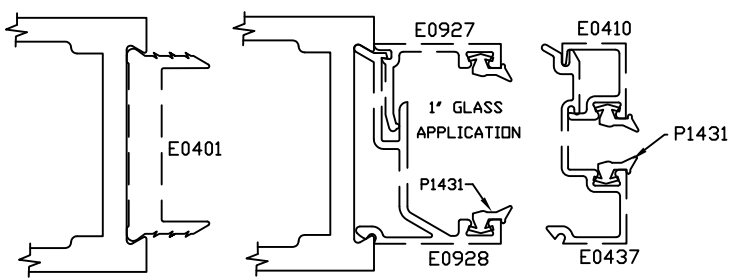
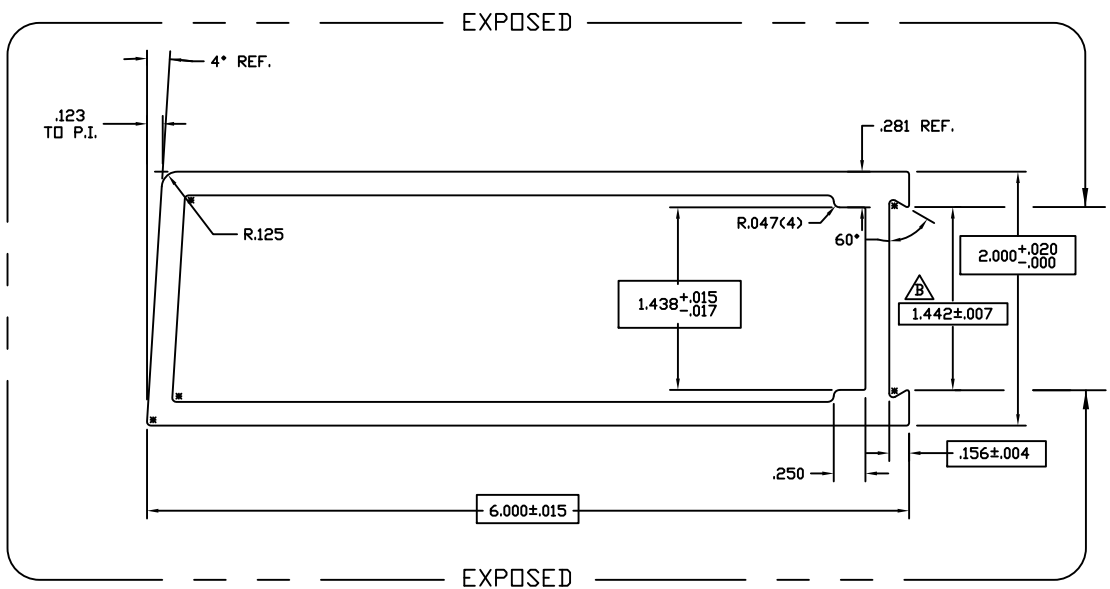

SNAP FIT W/E0437(1/4\"GLASS) AND E0928(1\"GLASS)

©2006 TUBELITE INC. ALL RIGHTS RESERVED
 ALUMINUM ASSOCIATION STANDARD
 TOLERANCES APPLY UNLESS NOTED
 ALL UNSPECIFIED RADII .015
 * INDICATES .031 RADIUS
 □ DENOTES CRITICAL DIMENSION
 ALL DIES PROPERTY OF TUBELITE

TUBELITE
 LEADING IN ECO-FRIENDLY OPERATING
 CURTAINWALL AND ENTRANCE SYSTEMS

3056 WALKER RIDGE NW, SUITE G
 WALKER, MICHIGAN 49544

WALL THK. .187	SECTION CLASS H	MAT'L 6063-T5	RATIO 19:1
PERIMETER OUT (TOTAL) 16.235(30.200)	AREA 2.892	WGT/FT 3.401	
FACTOR 9	CIRCLE SIZE 6.314	INFILL VOLUME N/A	
RXX .832	SXX 1.987	IXX 2.002	CXX 1.008
RYY 2.013	SYY 3.813	IYY 11.723	CYY 3.075

REV	DATE	DESCRIPTION	INTL
EP-1225	5/30/90	RELEASED TO TOOLING	
EP-1272	10/2/90	RELEASED TO PRODUCTION	DSM
A	01/09/01	1.449 +.000/- .010 WAS 1.438 +.002/- .013	CRH
B	08/2/05	1.442 +/- .007 WAS 1.449 +.000/- .010	CRH

BEVELED MON. VERT. STILE 2' X 6'
 CUSTOM DOORS/FRAMES

DRAWN BY DM	DRWG DATE 05/23/90	APPV'D BY MJC	DATE APPV'D 01/09/01
DWG SCALE NOTED	PRODUCT CODE 110	E2937	REV B

ATI

Report # B3772-116-45

Date 10/20/2011

Simulator Eric Barila

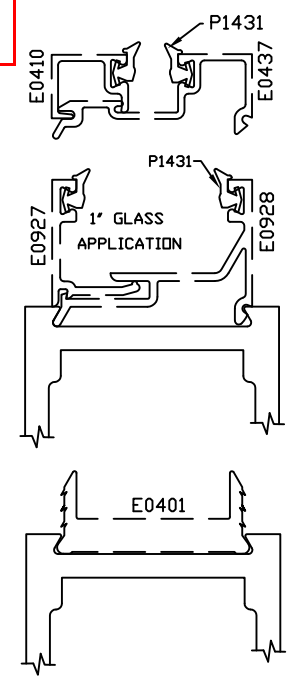
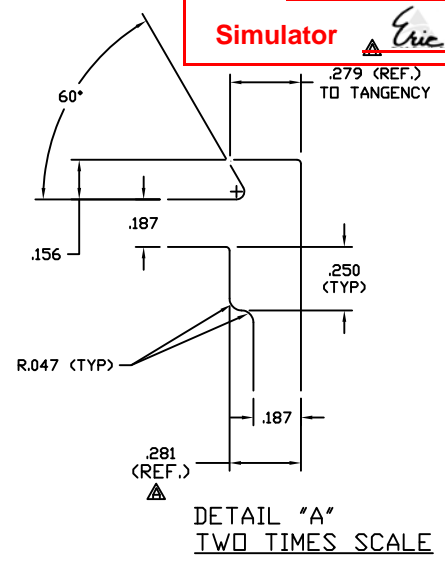
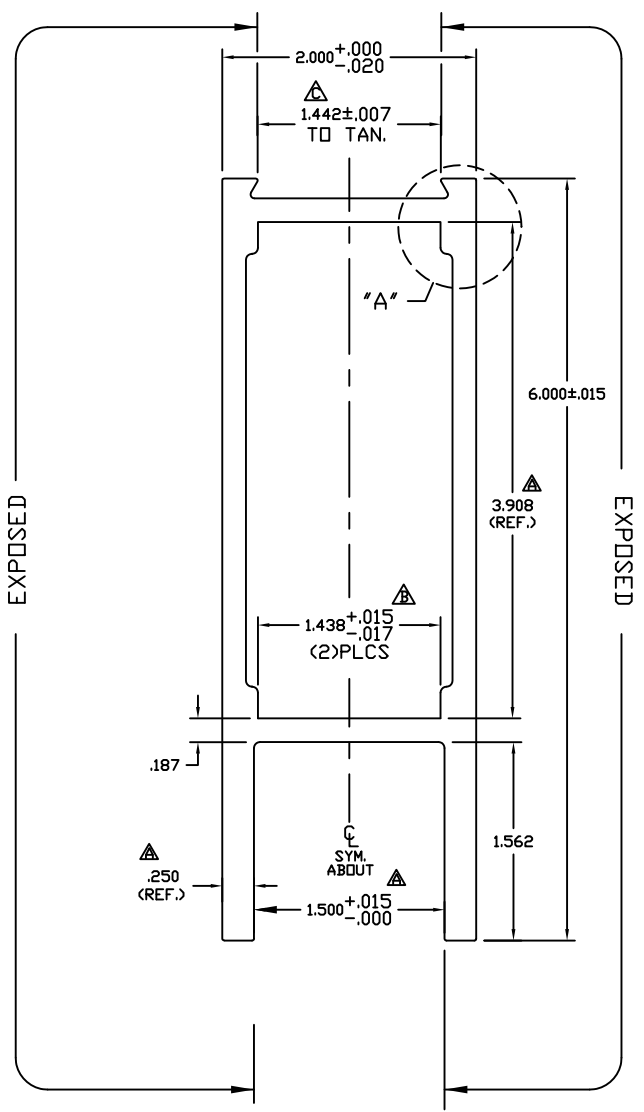

Use with door lugs P908
SNAP FIT W/E0437(1/4"GLASS) AND E0928(1"GLASS)

©2006 TUBELITE INC. ALL RIGHTS RESERVED
ALUMINUM ASSOCIATION STANDARD TOLERANCES APPLY UNLESS NOTED
ALL UNSPECIFIED RADII .015
* INDICATES .031 RADIUS
□ DENOTES CRITICAL DIMENSION
ALL DIES PROPERTY OF TUBELITE

3056 WALKER RIDGE NW, SUITE G
WALKER, MICHIGAN 49544

TUBELITE
LEADING IN ECO-FRIENDLY OPERATING CURTAINWALL AND ENTRANCE SYSTEMS

WALL THK	NOTED	SECTION H	MAT'L	6063-T5	RATIO	17:1	
PERIMETER OUT (TOTAL)	19.538(30.445)	AREA	3.161	WGT/FT	3.717		
FACTOR	8	CIRCLE SIZE	6.325	JNT'LL VOL/ME	N/A		
RXX	.829	SXX	2.172	IXX	2.172	CXX	1.000
RYY	1.874	SYX	3.659	IYY	11.104	CYY	3.035

MONUMENTAL HORIZONTAL RAIL 6" X 2"
CUSTOM DOORS/FAMES

DRAWN BY	DLH	DRWG DATE	08/06/64	APP'D BY	MJC	DATE APP'D	02/05/01
DWG SCALE	NOTED	PRODUCT CODE	110			E1051	C

ATI
Report # B3772-116-45
Date 10/20/2011
Simulator Eric Barila

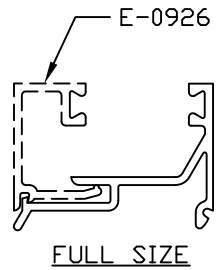
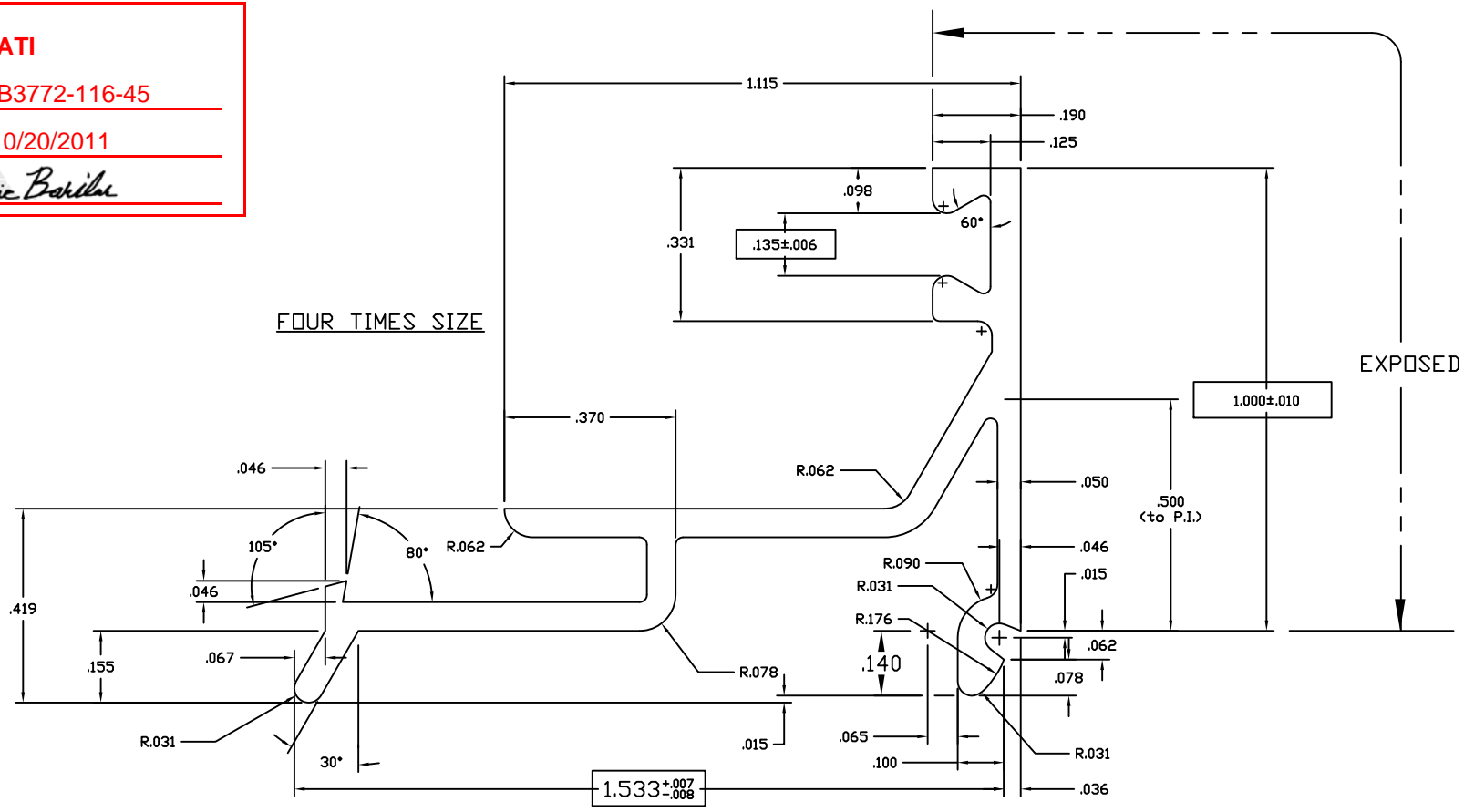

NOTES:

- 1) USE E-0927/0928 FOR 1" MAT'L
- 2) USE E-0926/0928 FOR 5/8" MAT'L
- 3) USE GLAZING BEAD P-302 FOR BOTH SIDES OF GLASS OR PANEL

©2006 TUBELITE INC. ALL RIGHTS RESERVED
 ALUMINUM ASSOCIATION STANDARD TOLERANCES APPLY UNLESS NOTED
 ALL UNSPECIFIED RADII .015
 * INDICATES .031 RADIUS
 DENOTES CRITICAL DIMENSION
 ALL DIES PROPERTY OF TUBELITE

TUBELITE
 LEADING IN ECO-FRIENDLY OPERATING CURTAINWALL AND ENTRANCE SYSTEMS
 3056 WALKER RIDGE NW, SUITE G
 WALKER, MICHIGAN 49544

WALL THK	.062	SECTION CLASS	S	MAT'L	6063-T5	RATIO	59:1
PERIMETER OUT (TOTAL)	7.540	AREA	.234	WGT/FT	.275		
FACTOR	27	CIRCLE SIZE	1.938	INFILL VOLUME	N/A		
RXX	.302	SXX	.030	IXX	.021	CXX	.701
RYY	.501	SYX	.113	IYY	.059	CYY	1.049

GLASS STOP, 1" HIGH FOR 1" GLASS STOCK DOORS

DRAWN BY	DWG DATE	07/03/84	APPV'D BY	DATE APPV'D
DWG SCALE	NOTED	PRODUCT CODE	100	E0928

REV	DATE	DESCRIPTION	INTL
	10/12/07	REMOVED LEG	RW

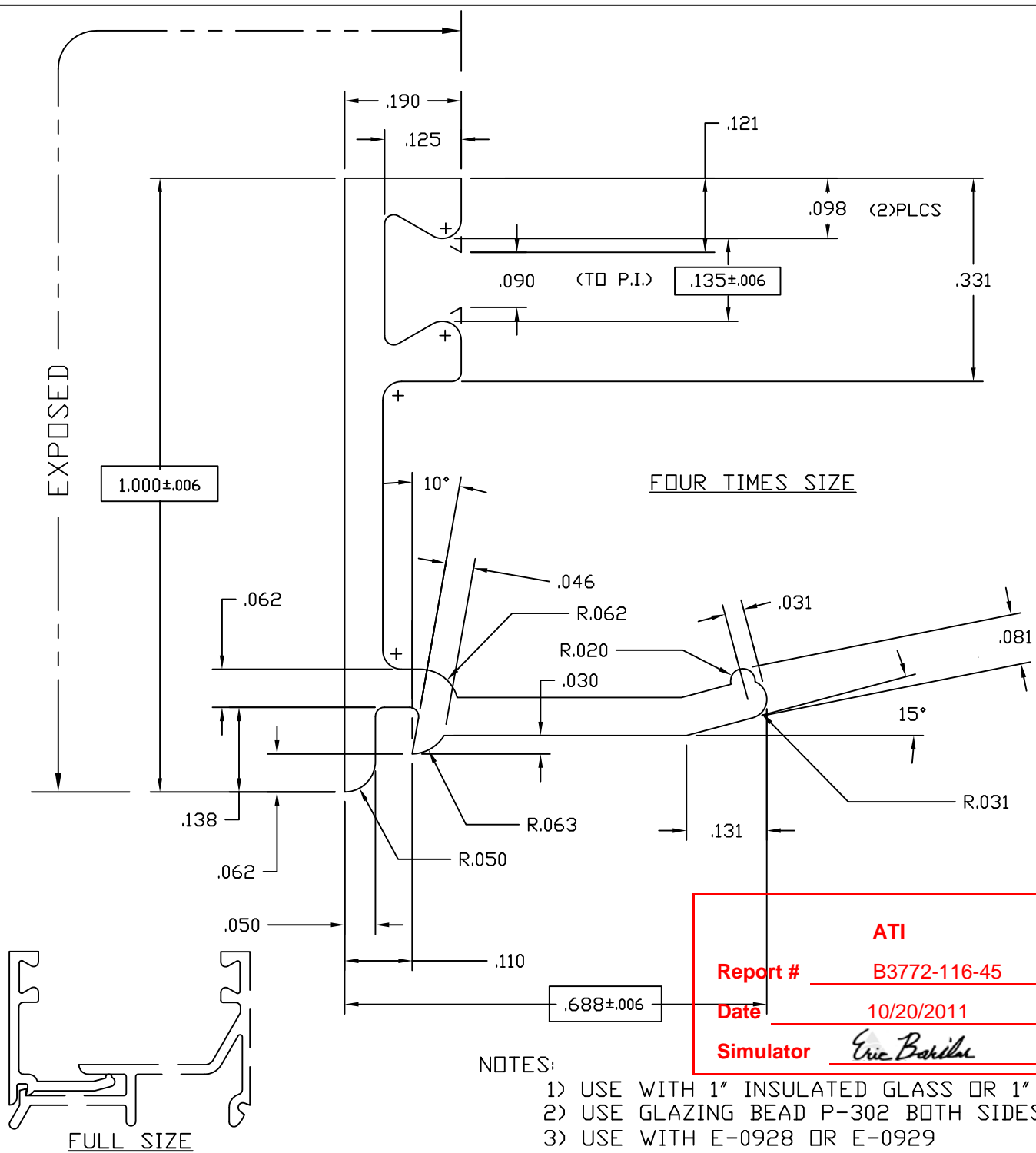

- NOTES:
- 1) USE WITH 1" INSULATED GLASS OR 1" PANEL
 - 2) USE GLAZING BEAD P-302 BOTH SIDES
 - 3) USE WITH E-0928 OR E-0929

© 2006 TUBELITE INC. ALL RIGHTS RESERVED
 ALUMINUM ASSOCIATION STANDARD TOLERANCES APPLY UNLESS NOTED
 ALL UNSPECIFIED RADII .015
 * INDICATES .031 RADIUS



3056 WALKER RIDGE NW, SUITE G
 WALKER, MICHIGAN 49544

WALL THK.	.062	SECTION CLASS	S	MAT'L	6063-T5	RATIO	74:1
PERIMETER OUT (TOTAL)	4.001	AREA	.124	WGT/FT	.146		
FACTOR	27	CIRCLE SIZE	1.120	INFILL VOLUME	N/A		

RXX	.321	SXX	.023	IXX	.013	CXX	.321
RYY	.185	SYY	.008	IYY	.004	CYY	.185

GLASS STOP, 1" HIGH FOR 1" GLASS STOCK DOORS

DRAWN BY	CRH	DRWG DATE	04/21/99	APPV'D BY		DATE APPV'D	
DWG SCALE	NOTED	PRODUCT CODE	100	E0927		REV	

REV	DATE	DESCRIPTION	INTL
X	xx/xx/xx	XXXXXXXXXXXXXXXX	XXX

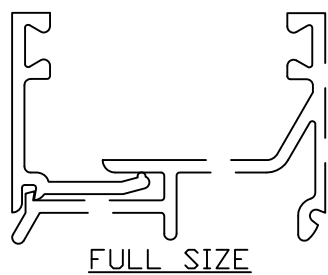

ATI
Report # B3772-116-45
Date 10/20/2011
Simulator Eric Barilko

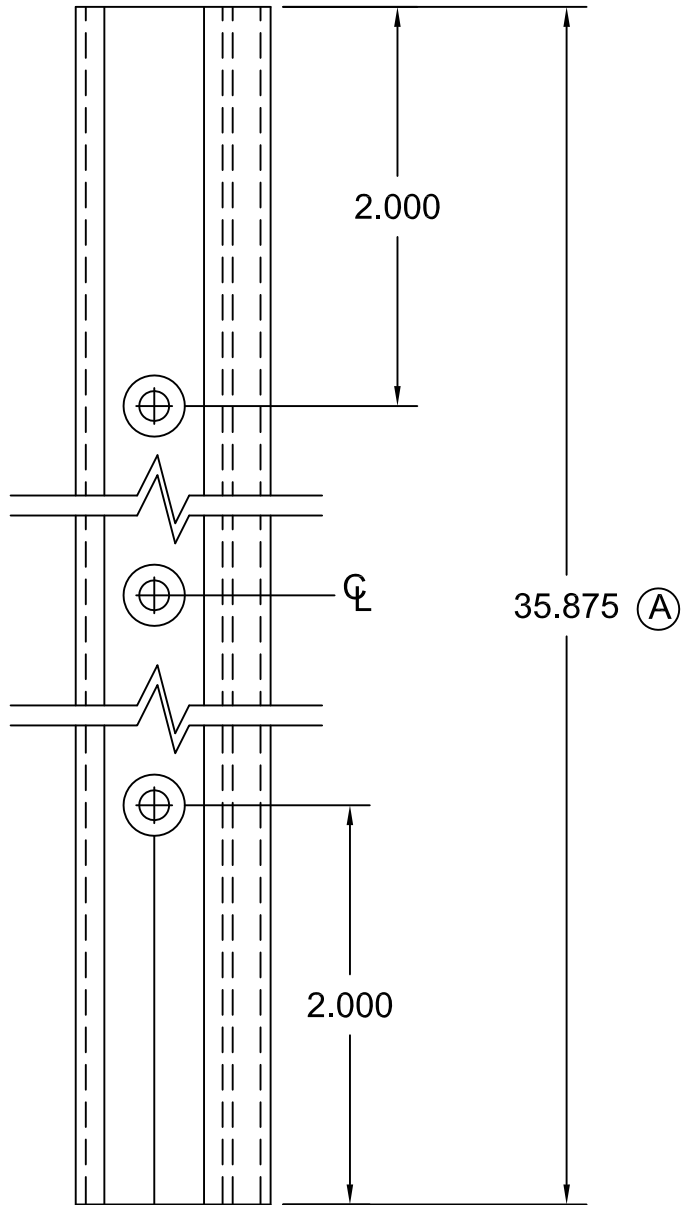

Operations:

1. Cut to length as required from E2059
2. Drill 3 holes with #25 Drl & Ctsk for S-064 (#6 FHCS)
3. Cut P-830 to length, Install, & Crimp ends
4. Cut P-914 to length, and install.
5. Paint ends as required
6. Ship with three (3) S064 Screws.

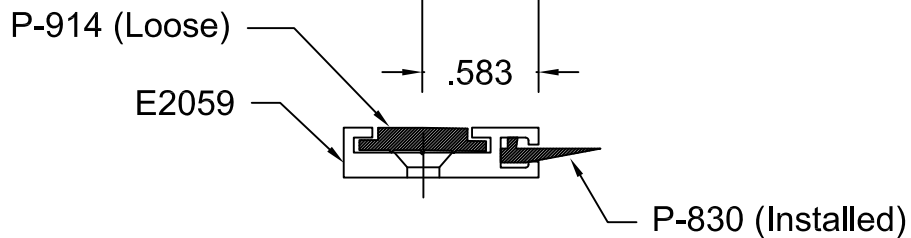

© 2006 TUBELITE INC. ALL RIGHTS RESERVED
 ALL UNSPECIFIED RADII .015
 * INDICATES .031 RADIUS
 □ DENOTES CRITICAL DIMENSION

TUBELITE®
 DEPENDABLE
 LEADERS IN ECO-EFFICIENT STOREFRONT,
 CURTAINWALL AND ENTRANCE SYSTEMS

3056 WALKER RIDGE NW, SUITE G
 WALKER, MICHIGAN 49544

REV	DATE	DESCRIPTION	INTL
	7/29/83	Released Part per ED 128	PJ
A	05/17/90	ED #1222 Dim was 34.875	KMH
B	8/24/01	Redrawn for CAD	DMT
C	06/19/03	OUTSOURCE - ADD S064 SCREWS	SRD

Door Seal to use with
 E2058 Threshold

DRAWN BY PJ	DRWG DATE 05/09/83	APPV,D BY	DATE APPV'D
DRWG SCALE Full	PRODUCT CODE 380	P1275	
			REV C

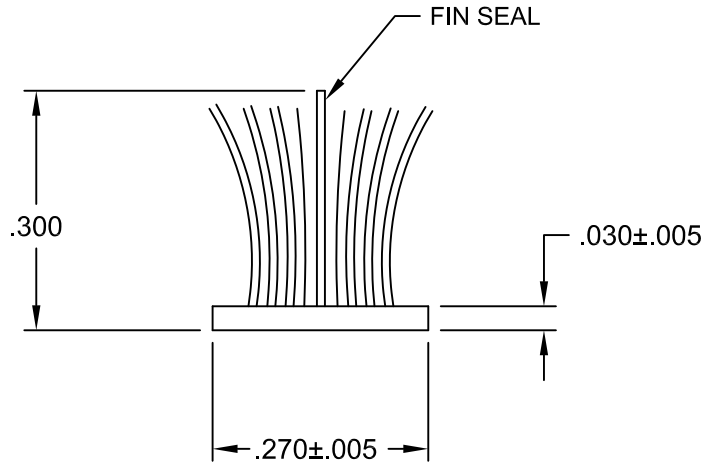

Actual Size

ATI

Report # B3772-116-45

Date 10/20/2011

Simulator Eric Bakula

© 2006 TUBELITE INC. ALL RIGHTS RESERVED

ALL UNSPECIFIED RADII .015

* INDICATES .031 RADIUS

DENOTES CRITICAL DIMENSION

TUBELITE®
DEPENDABLE
 LEADERS IN ECO-EFFICIENT STOREFRONT,
 CURTAINWALL AND ENTRANCE SYSTEMS

3056 WALKER RIDGE NW, SUITE G
 WALKER, MICHIGAN 49544

REV	DATE	DESCRIPTION	INTL
A	03/08/83	Release Part per ED 109	
B	05/29/02	Redrawn for CAD	DMT

<p>Poly Bond Fin-Seal Weathering use with Door Stop E1377</p>			
DRAWN BY	Don H	DRWG DATE	06/03/83
APPV,D BY		DATE APPV,D	
DRWG SCALE	Noted	PRODUCT CODE	380
<p style="text-align: center;">P1098A</p>			<p style="text-align: center;">B</p>

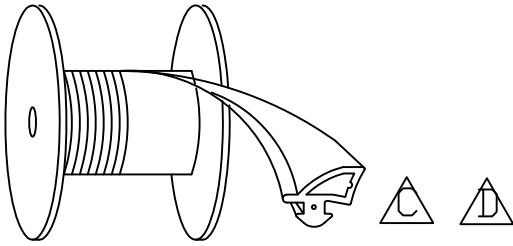

ATI

Report # B3772-116-45

Date 10/20/2011

Simulator Eric Barilko

P0017

E

Material must UNREEL like this...

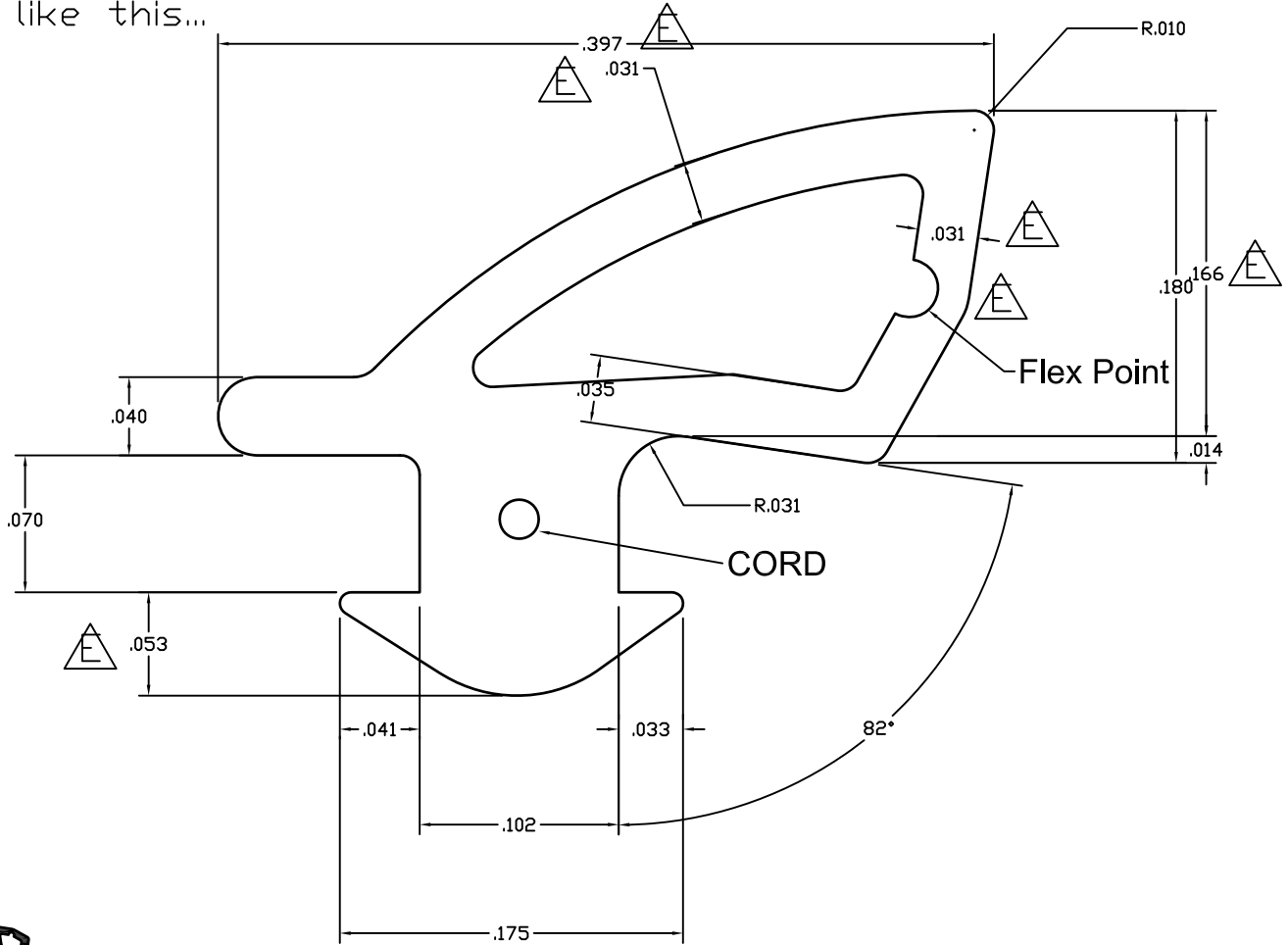

ACTUAL SIZE

MATERIAL: EPDM 60 DUROMETER WITH CORD

© 2006 TUBELITE INC. ALL RIGHTS RESERVED
 ALL UNSPECIFIED RADII .015
 * INDICATES .031 RADIUS
 □ DENOTES CRITICAL DIMENSION

TUBELITE®
 DEPENDABLE
 LEADERS IN ECO-EFFICIENT STOREFRONT,
 CURTAINWALL AND ENTRANCE SYSTEMS

3056 WALKER RIDGE NW, SUITE G
 WALKER, MICHIGAN 49544

REV	DATE	DESCRIPTION	INTL
A	08/20/07	MODIFIED DART: .070 WAS .060 AND .051 WAS .061 ADDED CORD	NIK
B	10/16/08	ADDED MANUFACTURER'S TOLERANCES FOR REFERENCE	SRD
C	10/22/10	Modified gasket position of how the reel should roll	TT
D	12/16/10	Modified gasket position of how the reel should roll	TT
E	02/15/11	Rev flex pt, thickness was .032, .180 was .188	TT

1/4"-1" DOOR GLAZING GASKET
 500' ROLLS

DRAWN BY NIK	DRWG DATE 4-17-07	APPV.D BY	DATE APPV'D	REV
DRWG SCALE 10X	PRODUCT CODE 100	P0017		E

ATI

Report # B3772-116-45

Date 10/20/2011

Simulator Eric Barilko

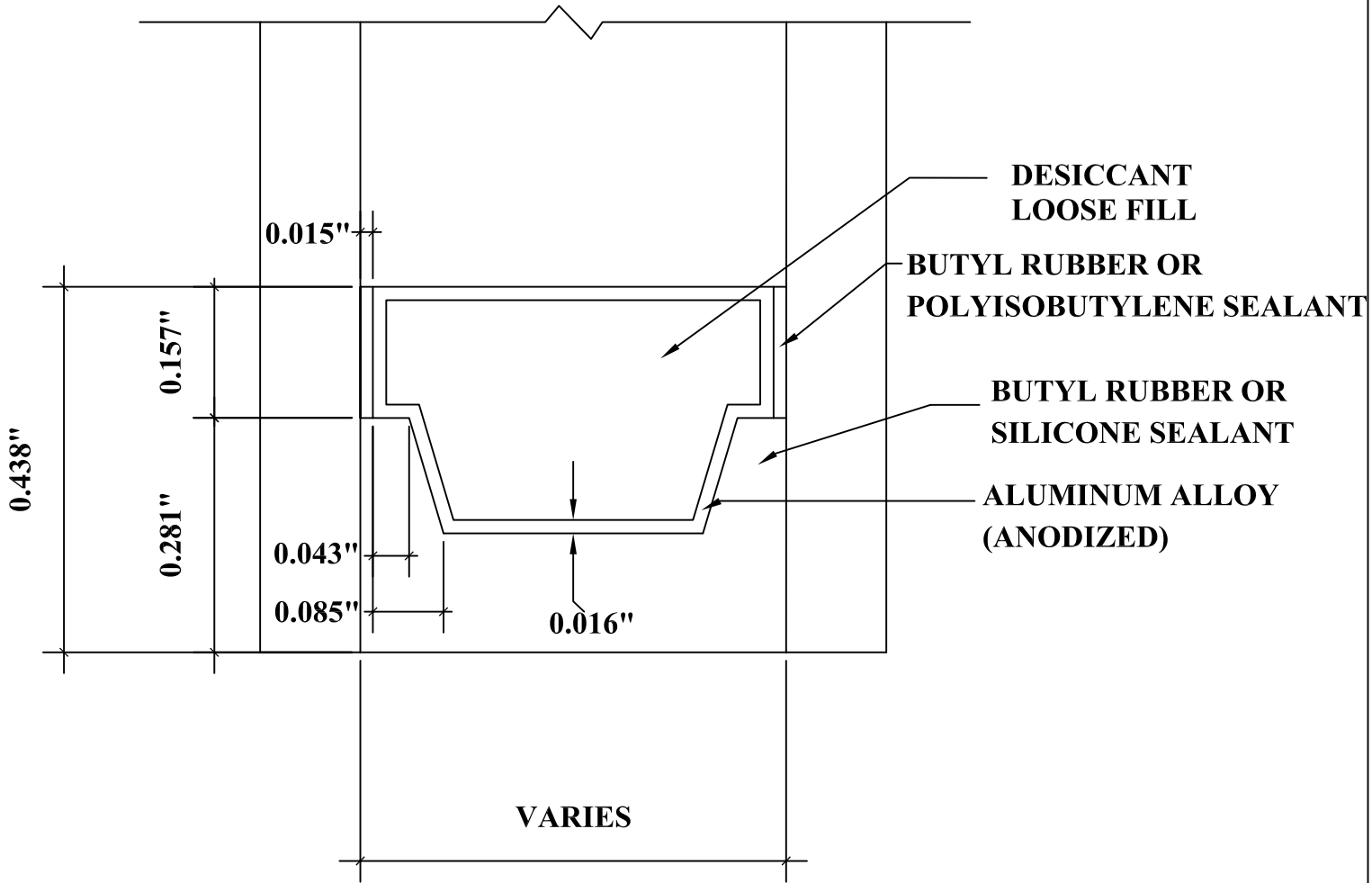

DETAIL FOR THERMAL MODELING OF
ALUMINUM SPACER (A1-D)