



AAMA 507-07 THERMAL PERFORMANCE REPORT

Rendered to:

TUBELITE, INC.

SERIES/MODEL: Standard 1-3/4" Narrow Stile Double Door

TYPE: Swinging Door - Double

Report No: B3772.15-116-45
Report Date: 10/27/11

AAMA 507-07 THERMAL PERFORMANCE REPORT

Rendered to:

TUBELITE, INC.
4878 Mackinaw Trail
Reed City, Michigan 49677

Report No: B3772.15-116-45
Report Date: 10/27/11
Simulation Date: 10/27/11

Project Summary:

Architectural Testing, Inc. was contracted by Tubelite, Inc. to provide U-Factor and Solar Heat Gain Coefficient thermal performance ratings on the Standard 1-3/4" Narrow Stile Double Door Swinging Door - Double. The thermal performance ratings were determined in accordance with AAMA 507-07, Standard Practice for Determining the Thermal Performance Characteristics of Fenestration Systems Installed in Commercial Building.

Reference Documents:

AAMA 507-07, Standard Practice for Determining the Thermal Performance Characteristics of Fenestration Systems Installed in Commercial Buildings

NFRC 100-2010, Procedure for Determining Fenestration Product U-Factors

NFRC 200-2010, Procedure for Determining Fenestration Product Solar Heat Gain Coefficient and Visible Transmittance at Normal Incidence

Simulation Specimen Description:

Series/Model:	Standard 1-3/4" Narrow Stile Double Door
Product Groupings:	1-3/4" Narrow w/o sweep grouped with 1-3/4" Narrow w/ sweep.
Type:	Swinging Door - Double
Frame Material:	Aluminum Framing System
Material Finish:	Painted Aluminum
Specimen Size:	1920mm wide by 2090mm high (75-1/2" by 82-3/8")
Configuration:	Two vision lites separated by one intermediate vertical
Drawing Reference:	Tubelite Standard Doors - 1-3/4" Frame Details

Tubelite, Inc.
Standard 1-3/4" Narrow Stile Double Door - Swinging Door - Double

System U-Factor vs. Percentage of Vision Area

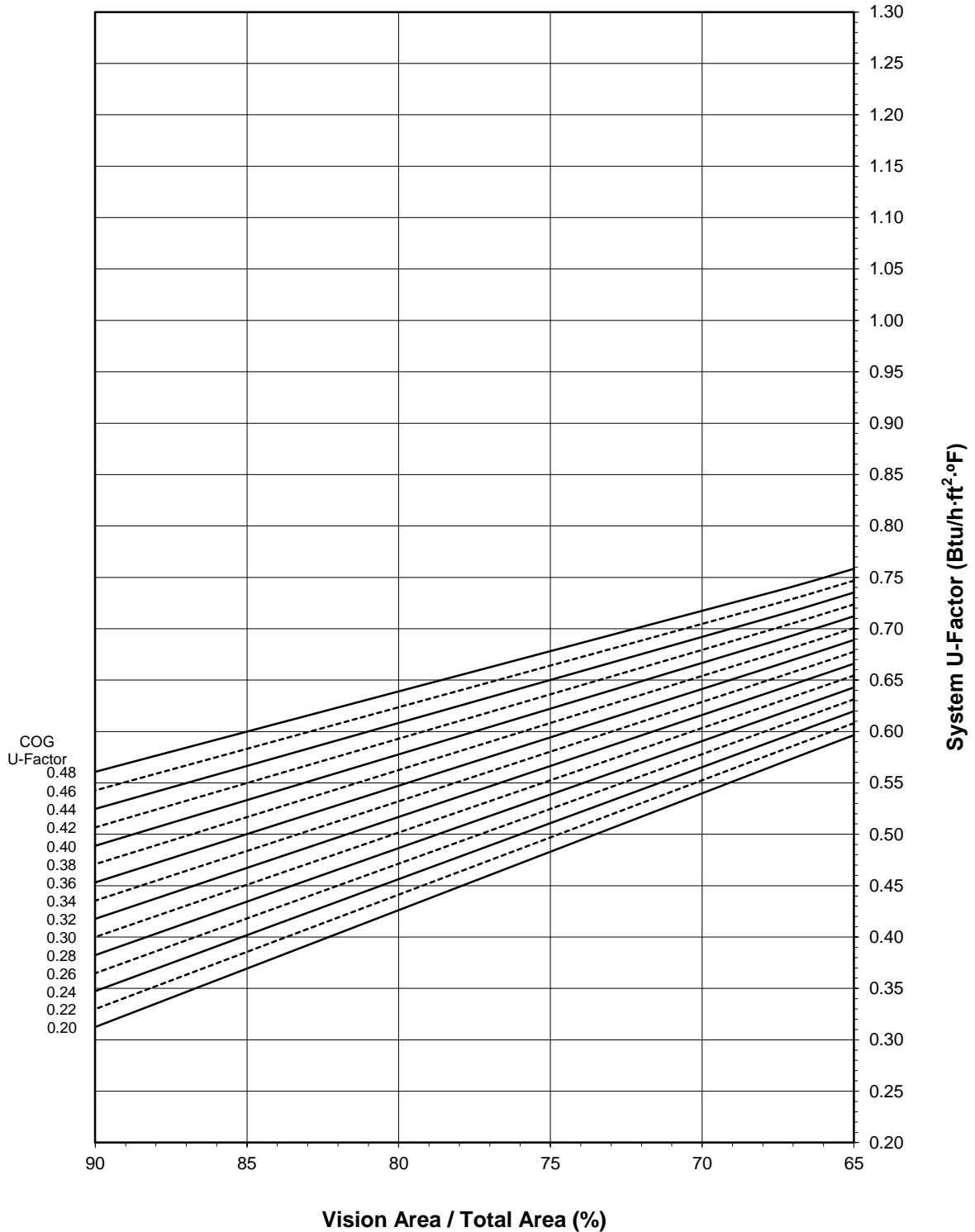

Note: 1 inch Overall - Dual Glazed Glass (0.48-0.20 COG) with Aluminum Spacer

Tubelite, Inc.
Standard 1-3/4" Narrow Stile Double Door - Swinging Door - Double

System SHGC vs. Percentage of Vision Area

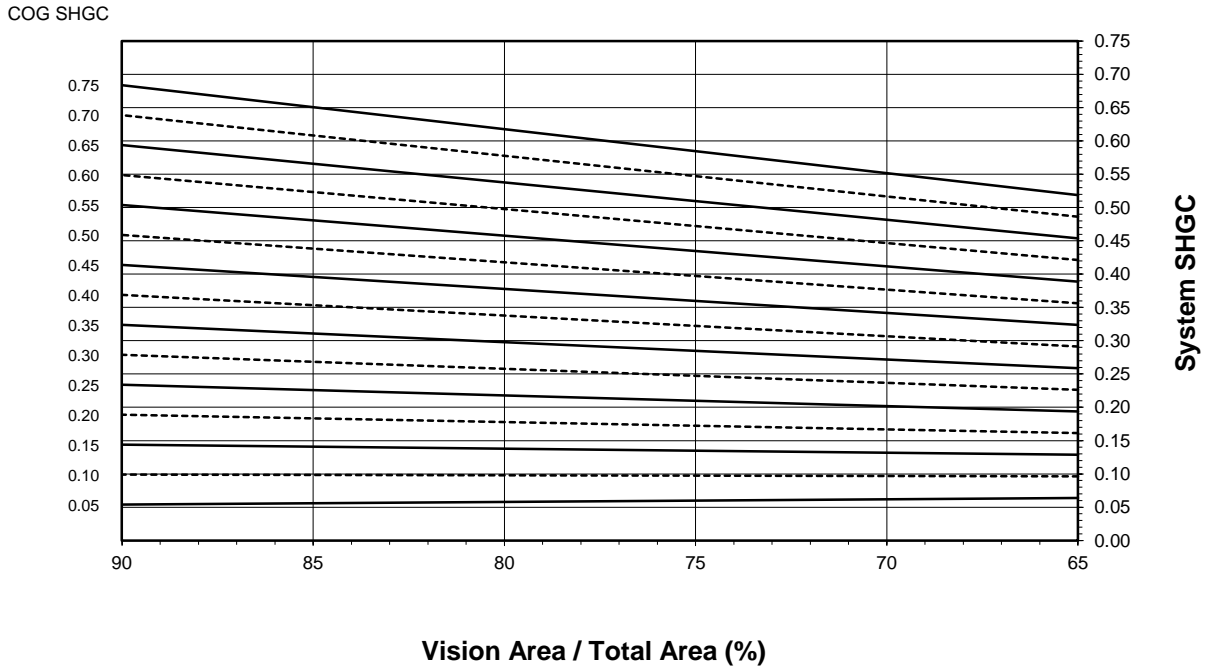

System VT vs. Percentage of Vision Area

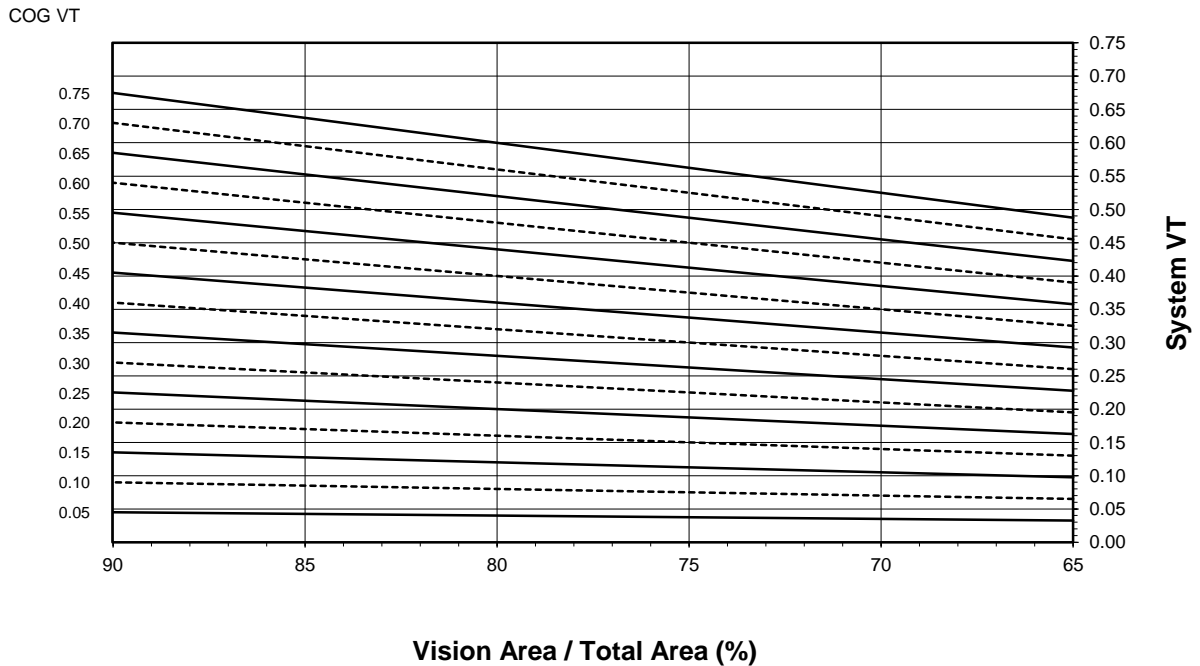

Tubelite, Inc.
Standard 1-3/4" Narrow Stile Double Door - Swinging Door - Double

Size Specific U-Factor Matrix*

Glazing Option	Center of Glass U-Factor	Overall U-Factor
1	0.48	0.74
2	0.46	0.72
3	0.44	0.71
4	0.42	0.70
5	0.40	0.69
6	0.38	0.68
7	0.36	0.66
8	0.34	0.65
9	0.32	0.64
10	0.30	0.63
11	0.28	0.62
12	0.26	0.60
13	0.24	0.59
14	0.22	0.58
15	0.20	0.57

Note: 1 inch Overall - Dual Glazed Glass (0.48-0.20 COG) with Aluminum Spacer

Size Specific SHGC Matrix*

Center of Glass SHGC	Overall SHGC
0.75	0.54
0.70	0.50
0.65	0.47
0.60	0.43
0.55	0.40
0.50	0.37
0.45	0.33
0.40	0.30
0.35	0.27
0.30	0.23
0.25	0.20
0.20	0.16
0.15	0.13
0.10	0.10
0.05	0.06

Size Specific VT Matrix*

Center of Glass VT	Overall VT
0.75	0.51
0.70	0.47
0.65	0.44
0.60	0.41
0.55	0.37
0.50	0.34
0.45	0.30
0.40	0.27
0.35	0.24
0.30	0.20
0.25	0.17
0.20	0.14
0.15	0.10
0.10	0.07
0.05	0.03

*Size Specific U-Factor, SHGC, and VT Matrices are based on the standard Swinging Door - Double specimen size of 1920mm wide by 2090mm high (75-1/2" by 82-3/8"). This represents 67.6% Vision Area / Total Area.

Vision Area Data

Option No.	COG U-Factor	COG Temperature	Cross Section	Frame Height	Frame U-Factor	Edge U-Factor	Total Product U-Factor		
							65% Vision Area	NFRC 100-2010	90% Vision Area
							69.44" by 75.59"	75.59" by 82.28"	260.58" by 283.66"
1	0.48	43.7	Ext. Head	5.0895	1.3040	0.5692	0.7583	0.7364	0.5608
			Int. Head	5.0895	1.3040	0.5692			
			Ext. Jamb	5.0262	1.3073	0.5700			
			Int. Jamb	5.0262	1.3073	0.5700			
			Mtg. Rail	6.6768	1.1420	0.5814			
			Ext. Sill	5.7770	1.2002	0.5820			
			Int. Sill	5.7770	1.2002	0.5820			
2	0.46	44.8	Ext. Head	5.0895	1.3041	0.5557	0.7468	0.7243	0.5427
			Int. Head	5.0895	1.3041	0.5557			
			Ext. Jamb	5.0262	1.3073	0.5564			
			Int. Jamb	5.0262	1.3073	0.5564			
			Mtg. Rail	6.6768	1.1417	0.5677			
			Ext. Sill	5.7770	1.2001	0.5684			
			Int. Sill	5.7770	1.2001	0.5684			
3	0.44	45.8	Ext. Head	5.0895	1.3041	0.5423	0.7353	0.7123	0.5247
			Int. Head	5.0895	1.3041	0.5423			
			Ext. Jamb	5.0262	1.3074	0.5430			
			Int. Jamb	5.0262	1.3074	0.5430			
			Mtg. Rail	6.6768	1.1414	0.5541			
			Ext. Sill	5.7770	1.1999	0.5548			
			Int. Sill	5.7770	1.1999	0.5548			
4	0.42	46.8	Ext. Head	5.0895	1.3042	0.5290	0.7237	0.7003	0.5067
			Int. Head	5.0895	1.3042	0.5290			
			Ext. Jamb	5.0262	1.3075	0.5297			
			Int. Jamb	5.0262	1.3075	0.5297			
			Mtg. Rail	6.6768	1.1411	0.5406			
			Ext. Sill	5.7770	1.1998	0.5413			
			Int. Sill	5.7770	1.1998	0.5413			
5	0.40	47.9	Ext. Head	5.0895	1.3043	0.5157	0.7122	0.6882	0.4888
			Int. Head	5.0895	1.3043	0.5157			
			Ext. Jamb	5.0262	1.3076	0.5165			
			Int. Jamb	5.0262	1.3076	0.5165			
			Mtg. Rail	6.6768	1.1408	0.5271			
			Ext. Sill	5.7770	1.1996	0.5279			
			Int. Sill	5.7770	1.1996	0.5279			
6	0.38	48.9	Ext. Head	5.0895	1.3043	0.5027	0.7007	0.6762	0.4710
			Int. Head	5.0895	1.3043	0.5027			
			Ext. Jamb	5.0262	1.3077	0.5034			
			Int. Jamb	5.0262	1.3077	0.5034			
			Mtg. Rail	6.6768	1.1405	0.5139			
			Ext. Sill	5.7770	1.1995	0.5147			
			Int. Sill	5.7770	1.1995	0.5147			

Vision Area Data

Option No.	COG U-Factor	COG Temperature	Cross Section	Frame Height	Frame U-Factor	Edge U-Factor	Total Product U-Factor		
							65% Vision Area	NFRC 100-2010	90% Vision Area
							69.44" by 75.59"	75.59" by 82.28"	260.58" by 283.66"
7	0.36	50.0	Ext. Head	5.0895	1.3044	0.4895	0.6891	0.6641	0.4532
			Int. Head	5.0895	1.3044	0.4895			
			Ext. Jamb	5.0262	1.3078	0.4903			
			Int. Jamb	5.0262	1.3078	0.4903			
			Mtg. Rail	6.6768	1.1403	0.5005			
			Ext. Sill	5.7770	1.1993	0.5014			
			Int. Sill	5.7770	1.1993	0.5014			
8	0.34	51.0	Ext. Head	5.0895	1.3045	0.4766	0.6776	0.6521	0.4355
			Int. Head	5.0895	1.3045	0.4766			
			Ext. Jamb	5.0262	1.3079	0.4777			
			Int. Jamb	5.0262	1.3079	0.4777			
			Mtg. Rail	6.6768	1.1400	0.4875			
			Ext. Sill	5.7770	1.1992	0.4884			
			Int. Sill	5.7770	1.1992	0.4884			
9	0.32	52.0	Ext. Head	5.0895	1.3046	0.4636	0.6660	0.6400	0.4177
			Int. Head	5.0895	1.3046	0.4636			
			Ext. Jamb	5.0262	1.3080	0.4646			
			Int. Jamb	5.0262	1.3080	0.4646			
			Mtg. Rail	6.6768	1.1397	0.4743			
			Ext. Sill	5.7770	1.1991	0.4752			
			Int. Sill	5.7770	1.1991	0.4752			
10	0.30	53.1	Ext. Head	5.0895	1.3047	0.4507	0.6545	0.6279	0.4001
			Int. Head	5.0895	1.3047	0.4507			
			Ext. Jamb	5.0262	1.3082	0.4518			
			Int. Jamb	5.0262	1.3082	0.4518			
			Mtg. Rail	6.6768	1.1395	0.4613			
			Ext. Sill	5.7770	1.1990	0.4623			
			Int. Sill	5.7770	1.1990	0.4623			
11	0.28	54.2	Ext. Head	5.0895	1.3048	0.4378	0.6429	0.6158	0.3825
			Int. Head	5.0895	1.3048	0.4378			
			Ext. Jamb	5.0262	1.3083	0.4389			
			Int. Jamb	5.0262	1.3083	0.4389			
			Mtg. Rail	6.6768	1.1393	0.4482			
			Ext. Sill	5.7770	1.1988	0.4492			
			Int. Sill	5.7770	1.1988	0.4492			
12	0.26	55.2	Ext. Head	5.0895	1.3049	0.4250	0.6313	0.6037	0.3649
			Int. Head	5.0895	1.3049	0.4250			
			Ext. Jamb	5.0262	1.3084	0.4260			
			Int. Jamb	5.0262	1.3084	0.4260			
			Mtg. Rail	6.6768	1.1390	0.4353			
			Ext. Sill	5.7770	1.1987	0.4363			
			Int. Sill	5.7770	1.1987	0.4363			

Vision Area Data

Option No.	COG U-Factor	COG Temperature	Cross Section	Frame Height	Frame U-Factor	Edge U-Factor	Total Product U-Factor		
							65% Vision Area	NFRC 100-2010	90% Vision Area
							69.44" by 75.59"	75.59" by 82.28"	260.58" by 283.66"
13	0.24	56.3	Ext. Head	5.0895	1.3050	0.4122	0.6198	0.5916	0.3474
			Int. Head	5.0895	1.3050	0.4122			
			Ext. Jamb	5.0262	1.3085	0.4132			
			Int. Jamb	5.0262	1.3085	0.4132			
			Mtg. Rail	6.6768	1.1388	0.4223			
			Ext. Sill	5.7770	1.1986	0.4234			
			Int. Sill	5.7770	1.1986	0.4234			
14	0.22	57.3	Ext. Head	5.0895	1.3051	0.3996	0.6081	0.5795	0.3300
			Int. Head	5.0895	1.3051	0.3996			
			Ext. Jamb	5.0262	1.3086	0.4008			
			Int. Jamb	5.0262	1.3086	0.4008			
			Mtg. Rail	6.6768	1.1386	0.4095			
			Ext. Sill	5.7770	1.1974	0.4094			
			Int. Sill	5.7770	1.1974	0.4094			
15	0.20	58.4	Ext. Head	5.0895	1.3053	0.3868	0.5965	0.5673	0.3125
			Int. Head	5.0895	1.3053	0.3868			
			Ext. Jamb	5.0262	1.3088	0.3880			
			Int. Jamb	5.0262	1.3088	0.3880			
			Mtg. Rail	6.6768	1.1384	0.3966			
			Ext. Sill	5.7770	1.1973	0.3965			
			Int. Sill	5.7770	1.1973	0.3965			

Detailed drawings, datasheets, representative samples of test specimens, a copy of this report, or other pertinent project documentation will be retained by Architectural Testing, Inc. for a period of four years from the original test date. At the end of this retention period such materials shall be discarded without notice and the service life of this report by Architectural Testing will expire. Results obtained are simulated values and were secured by using the designated test methods. This report does not constitute certification of this product nor an opinion or endorsement by this laboratory. It is the exclusive property of the client named herein and relates only to the specimen(s) simulated. This report may not be reproduced, except in full, without the written approval of Architectural Testing, Inc.

For ARCHITECTURAL TESTING, INC.:

SIMULATED BY:

REVIEWED BY:

Eric Barilar
Simulation Technician

Kevin S. Louder
Project Engineer

EAB:EAB
B3772.15-116-45

Attachments (pages): This report is complete only when all attachments listed are included.

Appendix A: Drawings and Bills of Material (23)

Revision Log

<u>Rev. #</u>	<u>Date</u>	<u>Page(s)</u>	<u>Revision(s)</u>
.01R0	10/27/2011	All	Original Report Issue

All drawings and Bills of Material used in simulating this product are enclosed in this Appendix.

STANDARD PAIR DOOR BOM -1.75 Frame

ATI

Report # B3772-116-45

Date 10/20/2011

Simulator *Eric Barilla*

FRAME:

Description	QTY	Length	Part number	Material
4500 Jamb 1.3/4" x 4 1/2"	2	82 3/8"	E4544	
Header 1 3/4" x 4 1/2"	1	34 1/4"	E45124	
	1	34 7/23" 80		
Header Door stops & Jambs	2	5/8"	E4531	
Fin Seal Weather pile	30 ft		P1098A	Vinyl
closure open back plate	2		E4543	

DOOR:

Description	QTY		Narrow P/N	Medium P/N	Wide P/N	Material
Beveled Door Stiles	2	79 13/16"	E0055 - 2 1/8"	E0086- 4"	E0416 - 5"	
Inactive Stile		79 13/16"	E0056 - 2 1/8"	E0087 - 4"	E0417 - 5"	
Astragal Stile		79 13/16"	E1149 - 2 1/8"	E1150 - 4"	E1151 - 5"	
Adjustable Astragal	1	79 13/16"	E1152	E1152	E1152	
Stainless Steel Clip for Adj. Astragal	8		P1539	P1539	P1539	Stainless Steel
Adj. Astragal Pile	2		P938	P938	P938	Vinyl
Door Top Rail	1	29 13/16"	E0255- 2 1/8"	E0054- 4"	E0318 - 5"	
Top Rail Lug	2		P168	P031	P339	AL
Door Botom Rail	1	29 13/16"	E0054- 4"	E0419- 6 1/2"	E0419- 6 1/2"	
Bottom Rail Lug	2		P031	P341	P341	AL
Top Rail & Bottom Rail Tie Rods	2	33 1/4"	P020B	P020	P020	Steel
Washer for Tie Rods	4		P852	P853	P853	steel/AL
Hex nuts for Tie rods	4		S071A	S071A	S071A	Steel

Exterior Glass Stop 1" glass 4
 Interior Glass Stop 1" glass 4
 Gasket 35.42
 Adjustable Wedge Setting Blck 2
 Self Adhesive Setting Blck 3

Threshold 1
 Threshold clip 2

E0927
 E0928
 P0017
 P1911
 P1912

E0019
 P679



Vinyl
 Polypropylene
 EPDM

AL

MATERIAL:

E - All E part numbers are AL extrusions

ATI	
Report #	<u>B3772-116-45</u>
Date	<u>10/20/2011</u>
Simulator	<u><i>Eric Barilac</i></u>

Standard Doors - Pairs

Jamb Detail -1 3/4" frame

Elevations & 1/4 Size Details

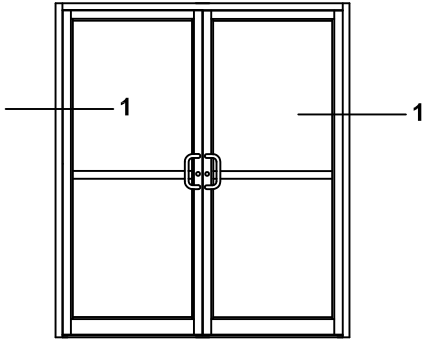

	ATI
Report #	<u>B3772-116-45</u>
Date	<u>10/20/2011</u>
Simulator	<u>Eric Basile</u>

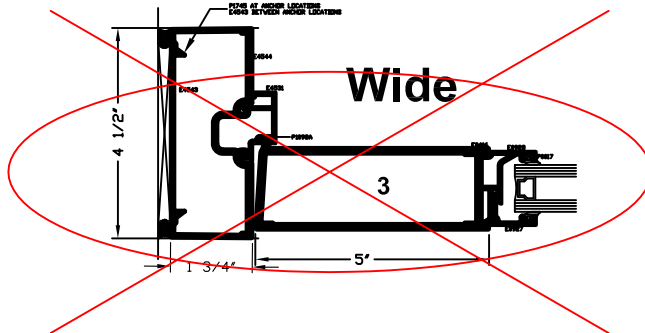
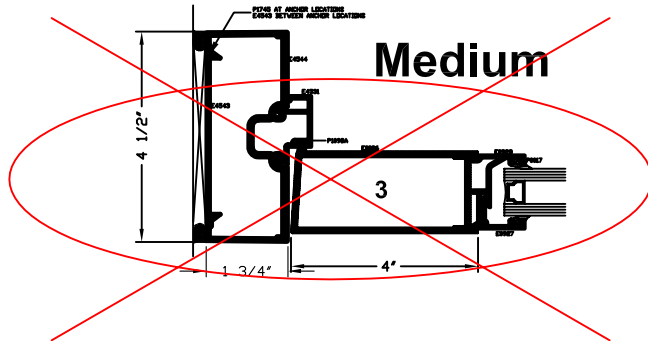
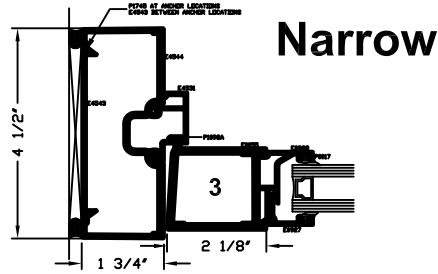

*SEALANT, ROD, & ANCHORS NOT BY TUBELITE

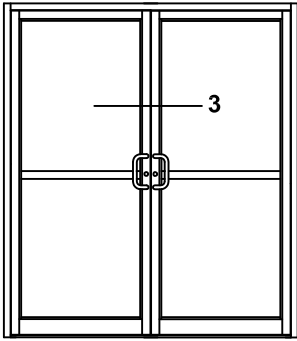

Standard Doors - Pairs

Meeting Stile Detail - 1 3/4" Frame

Elevations & 1/4 Size Details

ATI	
Report #	<u>B3772-116-45</u>
Date	<u>10/20/2011</u>
Simulator	<u>Eric Barilko</u>

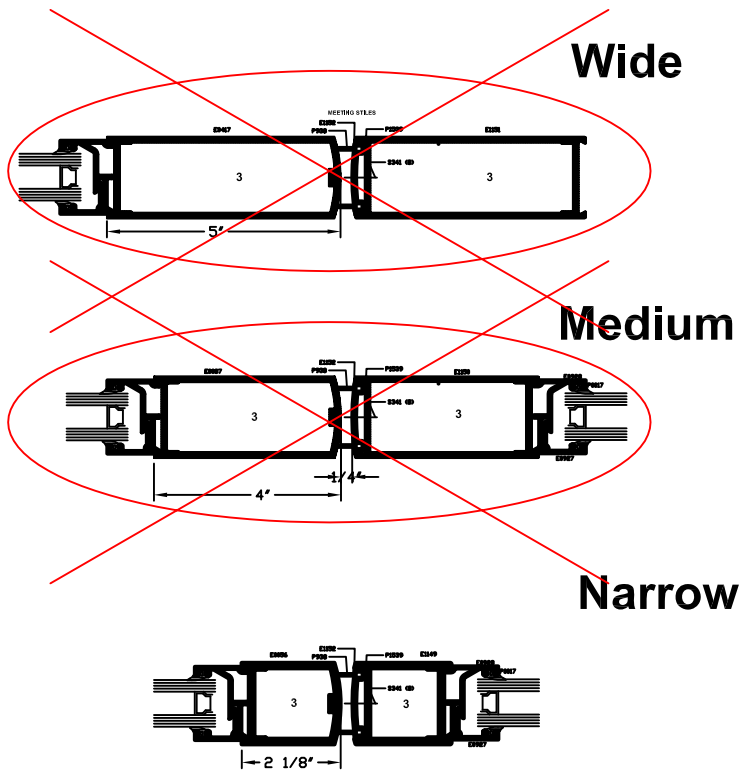

*SEALANT, ROD, & ANCHORS NOT BY TUBELITE

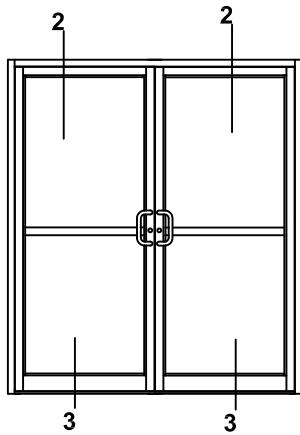

Standard Doors - Pairs

1 3/4" Frame

Elevations & 1/4 Size Details

ATI

Report # B3772-116-45

Date 10/20/2011

Simulator Eric Bahilan

Wide

Medium

Narrow

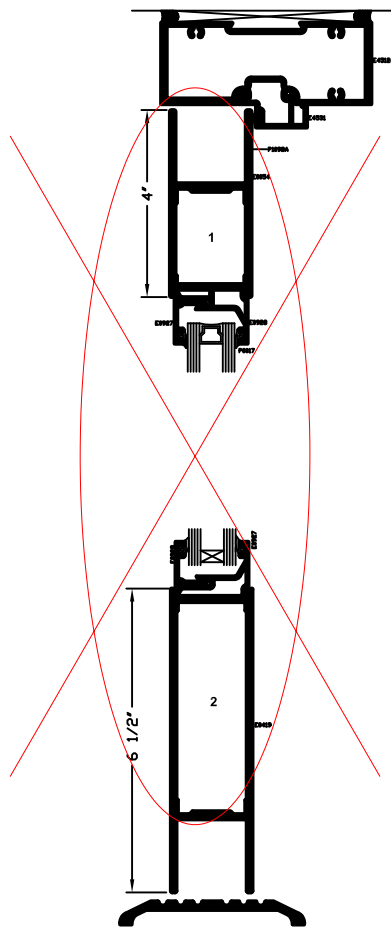
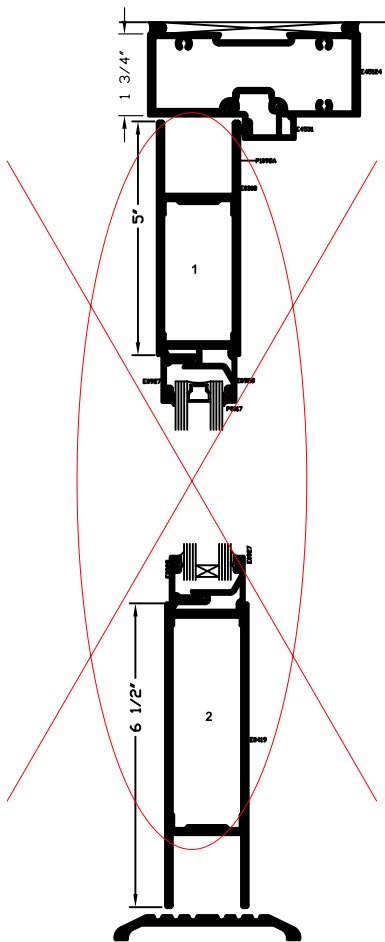

*SEALANT, ROD, & ANCHORS NOT BY TUBELITE

ATI

Report # B3772-116-45

Date 10/20/2011

Simulator Eric Bakula

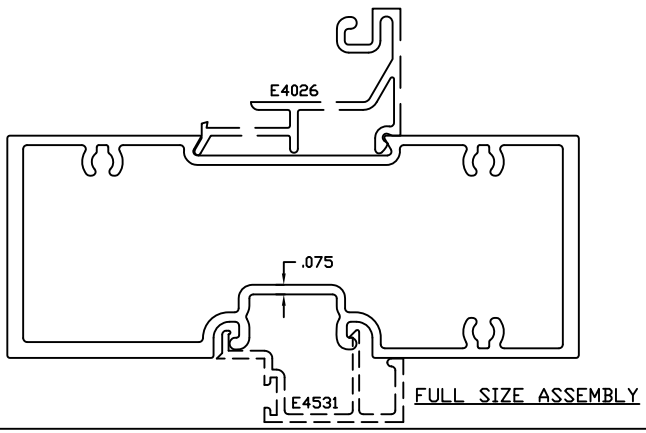
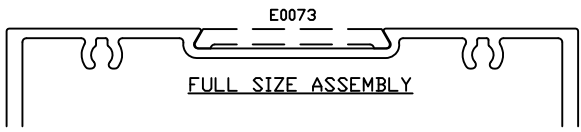
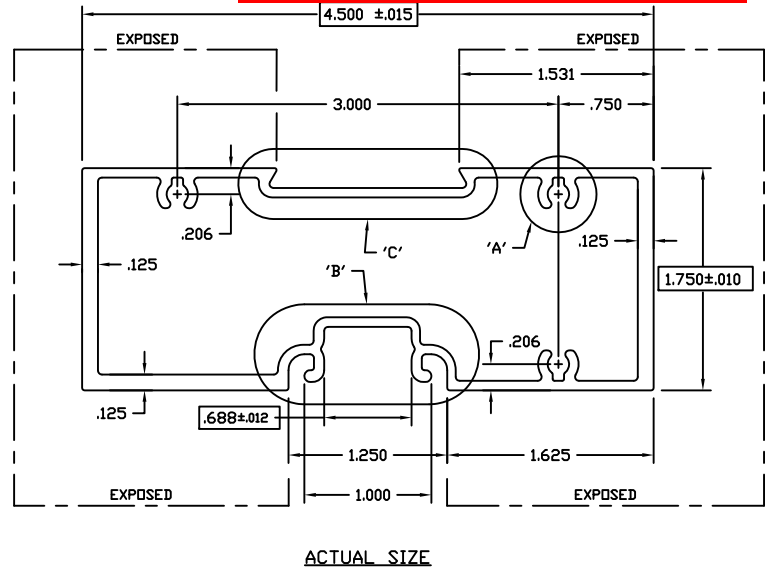
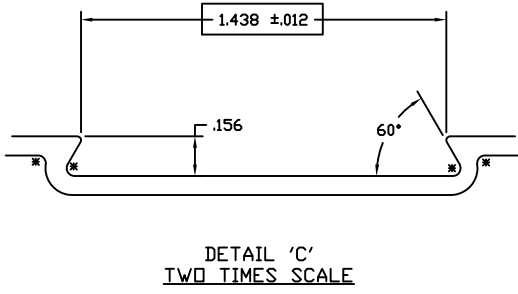
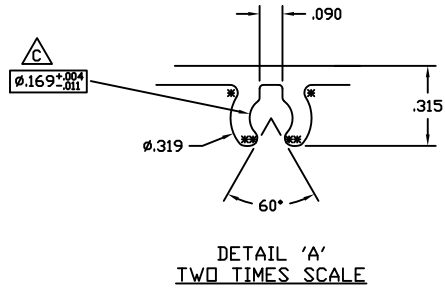
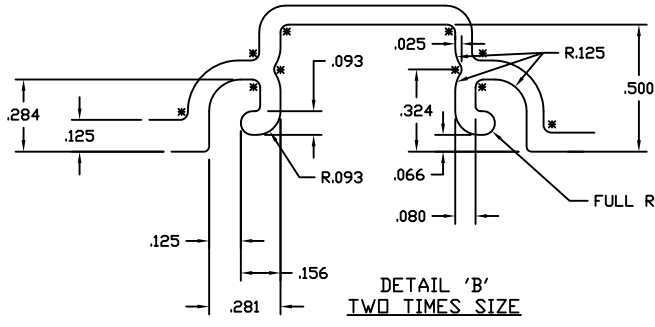

INDICATES CRITICAL DIMENSION

©2006 TUBELITE INC. ALL RIGHTS RESERVED
ALUMINUM ASSOCIATION STANDARD TOLERANCES APPLY UNLESS NOTED
ALL UNSPECIFIED RADII .015
* INDICATES .031 RADIUS
□ DENOTES CRITICAL DIMENSION
ALL DIES PROPERTY OF TUBELITE

TUBELITE
LEADER IN ECO-FRIENDLY OPERATING CURTAINWALL AND ENTRANCE SYSTEMS

3056 WALKER RIDGE NW, SUITE G
WALKER, MICHIGAN 49544

WALL THK	.075	SECTION H CLASS	MAT'L	6063-T5	RATIO	40:1	
PERIMETER DUT (TOTAL)	14.791(29.991)	AREA	1.392	WGT/FT	1.637		
FACTOR	19	CIRCLE SIZE	4.828	INT'L VOLUME	N/A		
RXX	1.589	SXX	1.539	IXX	3.516	CXX	2.285
RYY	.678	SYY	.701	IYY	.639	CYY	.913

DOOR HEADER 1 3/4" X 4 1/2"
E4500 STOREFRONT

DRAWN BY	SRD	DRWG DATE	12/08/02	APP'D BY		DATE APP'D	
DWG SCALE	NOTED	PRODUCT CODE	160		E45124		C

REV	DATE	DESCRIPTION	INTL
EDI729	5-17-93	RELEASE TO TOOLING	KMH
EDI764	7-7-93	REVISE EXTR. # WAS E-45007	KMH
EDI772	7-28-93	RELEASE TO PRODUCTION	KMH
A	11-8-95	REVISED SCREW BOSS	SRK
EDI231	11-8-95	RELEASE TO TOOLING	SRK
B	03/07/03	REVISED GL. POCKET AND REGLET - REDUCED WEIGHT	SRD
	03/07/03	RENAMED E912C15 - RELEASE FOR PRODUCTION	SRD
C	09/15/10	.169 +.004/-011, WAS .162±.004	CRH

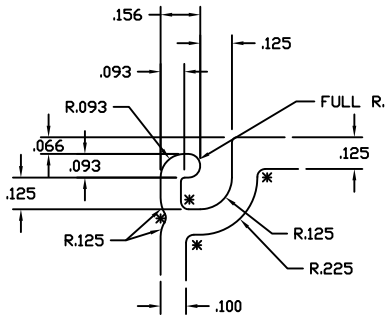

DETAIL 'A'
TWO TIMES SIZE

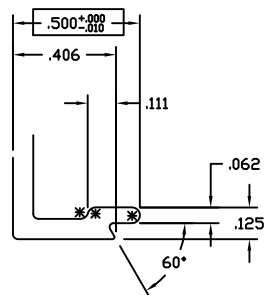

DETAIL 'B'
TWO TIMES SIZE

ATI

Report # B3772-116-45

Date 10/20/2011

Simulator Eric Bahler

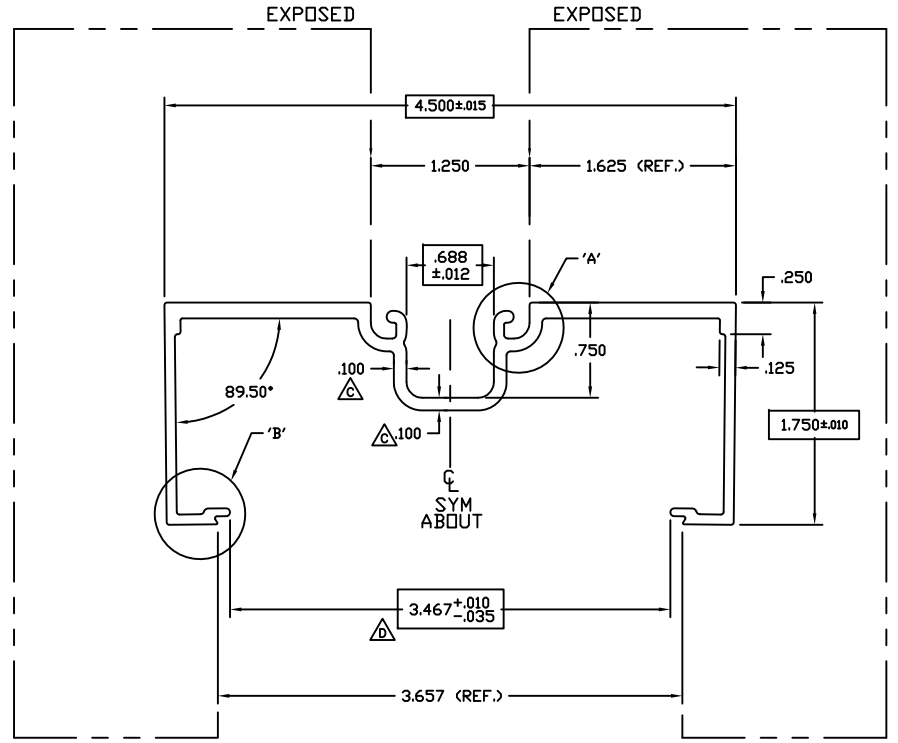

FULL SIZE

INDICATES CRITICAL DIMENSION

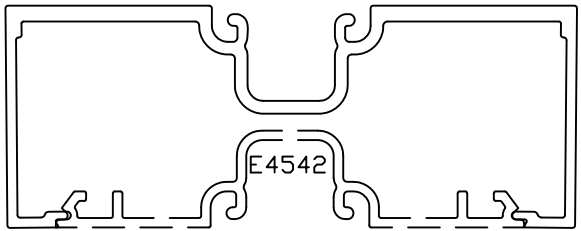

ASSEMBLY

©2006 TUBELITE INC. ALL RIGHTS RESERVED
ALUMINUM ASSOCIATION STANDARD TOLERANCES APPLY UNLESS NOTED
ALL UNSPECIFIED RADII .015
* INDICATES .031 RADIUS
□ DENOTES CRITICAL DIMENSION
ALL DIES PROPERTY OF TUBELITE

TUBELITE
LEADING IN ECO-FRIENDLY OPERATING CURTAINWALL AND ENTRANCE SYSTEMS

3056 WALKER RIDGE NW, SUITE G
WALKER, MICHIGAN 49544

WALL THK	.080	SECTION CLASS	S	MAT'L	6063-T5	RATIO	53:1
PERIMETER OUT (TOTAL)	20.704	AREA	1.030	WGT/FT	1.211		
FACTOR	17	CIRCLE SIZE	4.802	IN/FILL VOLUME	N/A		
RXX	1.577	SXX	1.139	IXX	2.562	CXX	2.250
RYY	.543	SYY	.245	IYY	.304	CYY	1.241

OPEN BACK FRAME 1 3/4" X 4 1/2"
E4500 STOREFRONT

DRAWN BY	SRD	DRWG DATE	12/08/02	APPV'D BY		DATE APPV'D	
BWG SCALE	NOTED	PRODUCT CODE	160	E4544		REV	C

ATI
Report # B3772-116-45
Date 10/20/2011
Simulator Eric Barilla

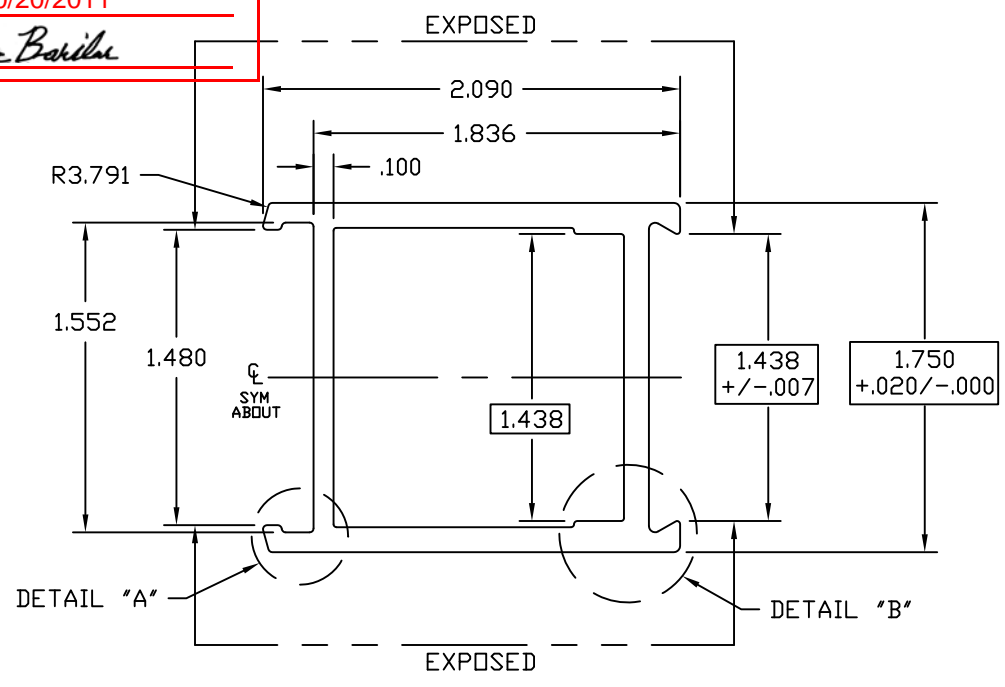

ACTUAL SIZE

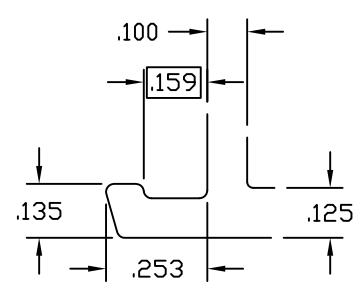

DETAIL "A"
TWO TIMES SIZE

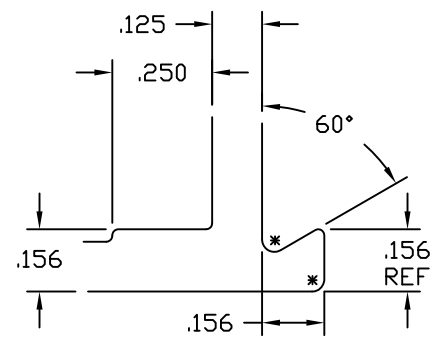

DETAIL "B"
TWO TIMES SIZE

DENOTES CRITICAL DIMENSION

© 2006 TUBELITE INC. ALL RIGHTS RESERVED
 ALUMINUM ASSOCIATION STANDARD
 TOLERANCES APPLY UNLESS NOTED
 ALL UNSPECIFIED RADII .015
 * INDICATES .031 RADIUS



3056 WALKER RIDGE NW, SUITE G
 WALKER, MICHIGAN 49544

WALL THK.	NOTED	SECTION CLASS	H	MAT'L	6063-T5	RATIO	64:1
PERIMETER OUT (TOTAL)	8.586(14.445)	AREA	.865	WGT/FT	1.018		
FACTOR	15	CIRCLE SIZE	2.684	INFILL VOLUME	N/A		

RXX	.689	SXX	.469	IXX	.411	CXX	.875
RYY	.675	SYX	.406	IYY	.395	CYY	1.117

ADJ. ASTRAGAL STILE 1 3/4" X 2 1/8"
 STOCK DOORS

REV	DATE	DESCRIPTION	INTL
X	XXXXXX	RELEASED FOR PRODUCTION - WAS E902H05 - ER-080702	LDD

DRAWN BY	LDD	DRWG DATE	02/08/07	APPV'D BY		DATE APPV'D	
DWG SCALE	NOTED	PRODUCT CODE	100	E1149			

ATI
Report # B3772-116-45
Date 10/20/2011
Simulator Eric Barilan

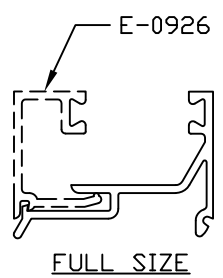
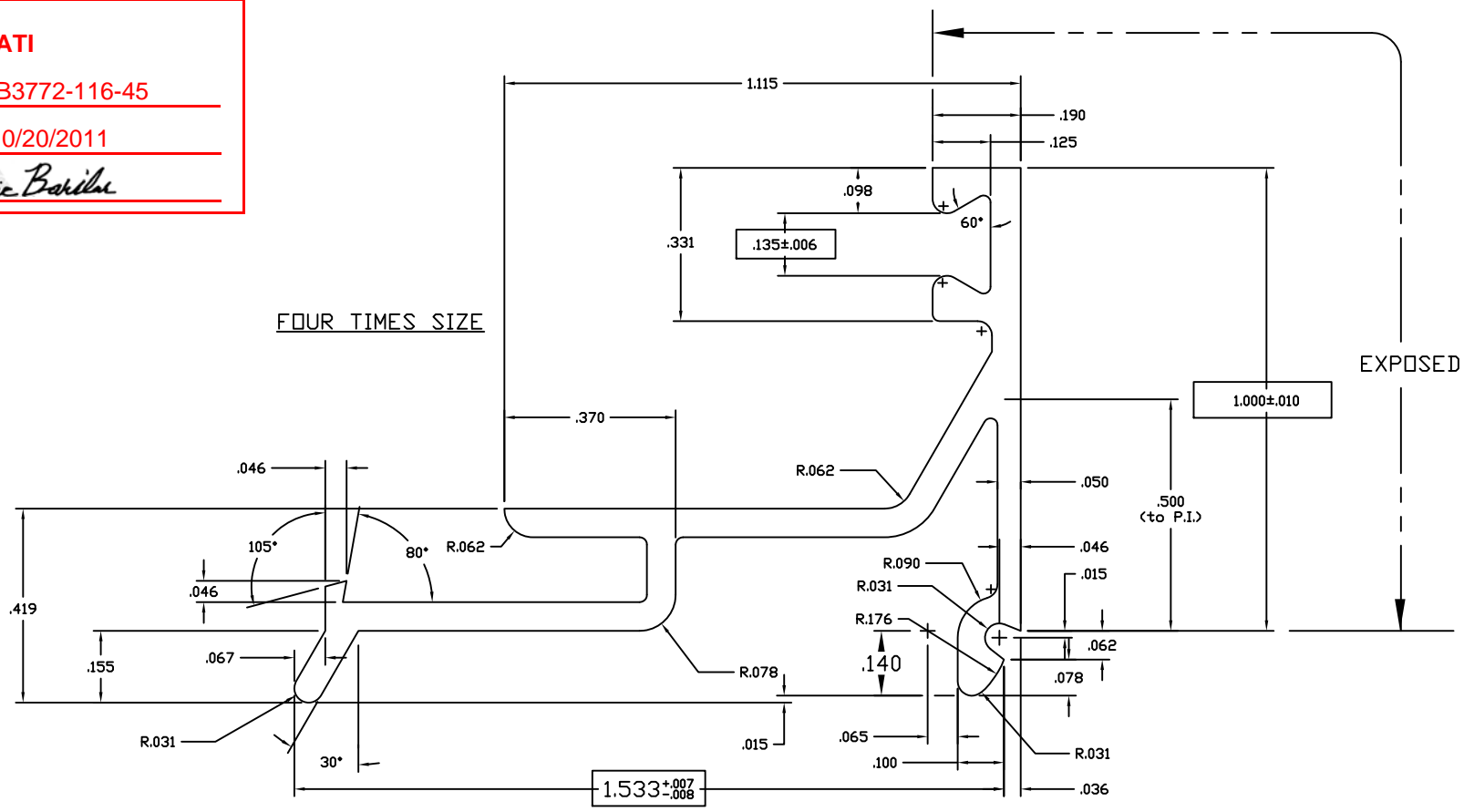

NOTES:

- 1) USE E-0927/0928 FOR 1" MAT'L
- 2) USE E-0926/0928 FOR 5/8" MAT'L
- 3) USE GLAZING BEAD P-302 FOR BOTH SIDES OF GLASS OR PANEL

©2006 TUBELITE INC. ALL RIGHTS RESERVED
 ALUMINUM ASSOCIATION STANDARD TOLERANCES APPLY UNLESS NOTED
 ALL UNSPECIFIED RADII .015
 * INDICATES .031 RADIUS
 DENOTES CRITICAL DIMENSION
 ALL DIES PROPERTY OF TUBELITE

TUBELITE
 LEADING IN ECO-FRIENDLY OPERATING CURTAINWALL AND ENTRANCE SYSTEMS
 3056 WALKER RIDGE NW, SUITE G
 WALKER, MICHIGAN 49544

WALL THK	.062	SECTION CLASS	S	MAT'L	6063-T5	RATIO	59:1
PERIMETER OUT (TOTAL)	7.540	AREA	.234	WGT/FT	.275		
FACTOR	27	CIRCLE SIZE	1.938	INFILL VOLUME	N/A		
RXX	.302	SXX	.030	IXX	.021	CXX	.701
RYY	.501	SYX	.113	IYY	.059	CYY	1.049

GLASS STOP, 1" HIGH FOR 1" GLASS STOCK DOORS

DRAWN BY	DWG DATE	07/03/84	APPV'D BY	DATE APPV'D
DWG SCALE	NOTED	PRODUCT CODE	100	E0928

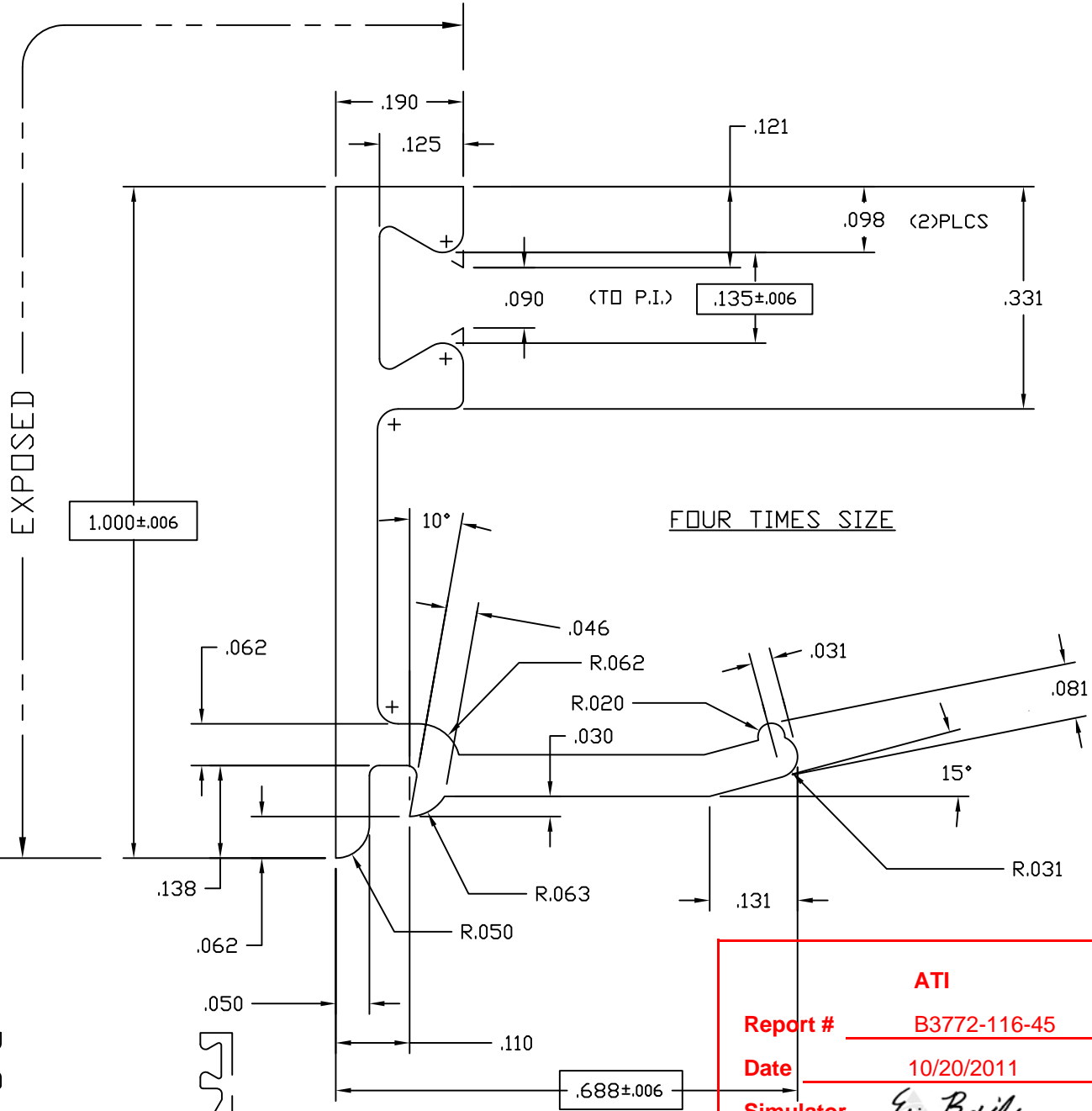

FOUR TIMES SIZE

ATI

Report # B3772-116-45

Date 10/20/2011

Simulator Eric Barilla

NOTES:

- 1) USE WITH 1" INSULATED GLASS OR 1" PANEL
- 2) USE GLAZING BEAD P-302 BOTH SIDES
- 3) USE WITH E-0928 OR E-0929

© 2006 TUBELITE INC. ALL RIGHTS RESERVED
 ALUMINUM ASSOCIATION STANDARD TOLERANCES APPLY UNLESS NOTED
 ALL UNSPECIFIED RADII .015
 * INDICATES .031 RADIUS



3056 WALKER RIDGE NW, SUITE G
 WALKER, MICHIGAN 49544

WALL THK.	.062	SECTION CLASS	S	MAT'L	6063-T5	RATIO	74:1
PERIMETER OUT (TOTAL)	4.001	AREA	.124	WGT/FT	.146		
FACTOR	27	CIRCLE SIZE	1.120	INFILL VOLUME	N/A		

RXX	.321	SXX	.023	IXX	.013	CXX	.321
RYY	.185	SYY	.008	IYY	.004	CYY	.185

GLASS STOP, 1" HIGH FOR 1" GLASS STOCK DOORS

DRAWN BY	CRH	DRWG DATE	04/21/99	APPV'D BY		DATE APPV'D	
DWG SCALE	NOTED	PRODUCT CODE	100	E0927		REV	

REV	DATE	DESCRIPTION	INTL
X	xx/xx/xx	xxxxxxxxxxxxxx	xxx

☐ DENOTES CRITICAL DIMENSION
 ALL DIES PROPERTY OF TUBELITE

E0255
A

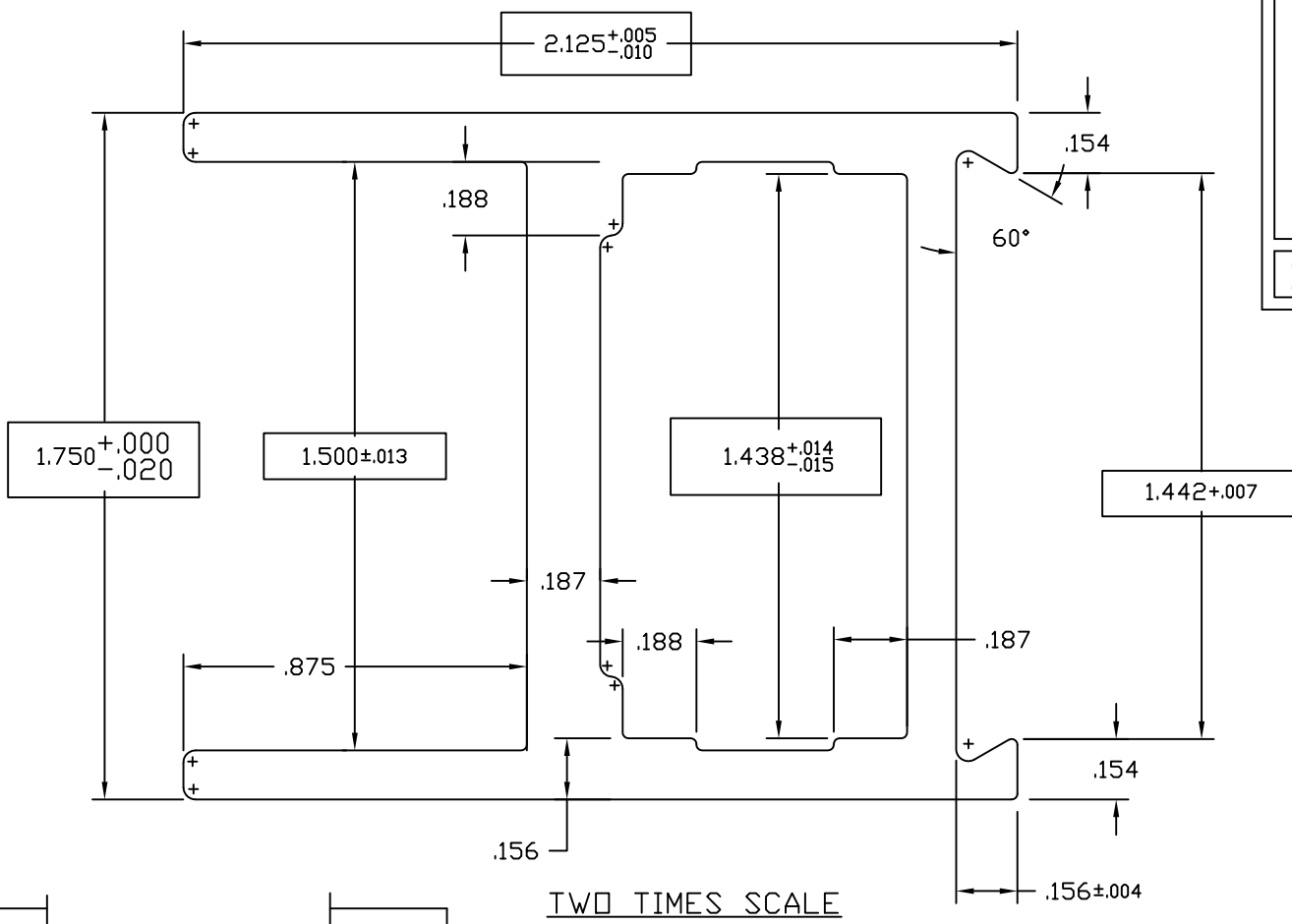

TWO TIMES SCALE

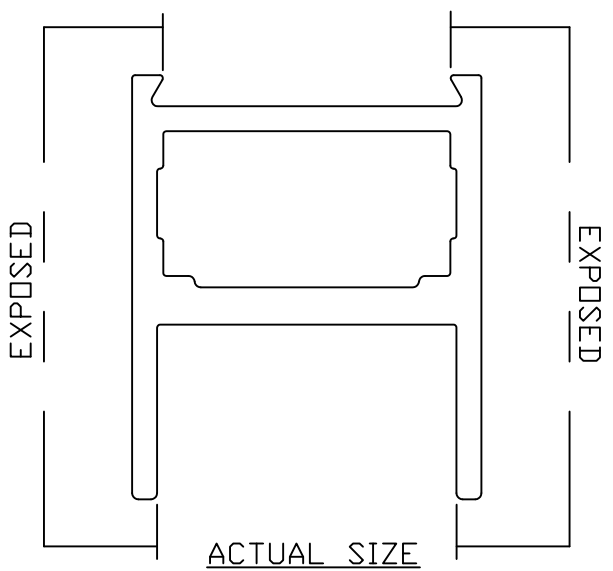

ACTUAL SIZE

ATI

Report # B3772-116-45

Date 10/20/2011

Simulator Eric Baskin

.125 +.003/-0.011 TYP WALL THICKNESS

INDICATES CRITICAL DIMENSION

SNAP FIT W/E-0437

+ INDICATES .031 RAD (10 PLCS)

© 2006 TUBELITE INC. ALL RIGHTS RESERVED
ALUMINUM ASSOCIATION STANDARD TOLERANCES APPLY UNLESS NOTED
ALL UNSPECIFIED RADII .015
* INDICATES .031 RADIUS

TUBELITE
DEPENDABLE
LEADERS IN ECO-EFFICIENT STOREFRONT, CURTAINWALL AND ENTRANCE SYSTEMS

3056 WALKER RIDGE NW, SUITE G
WALKER, MICHIGAN 49544

WALL THK.	NOTED	SECTION CLASS	H	MAT'L	6063-T5	RATIO	53:1
PERIMETER OUT (TOTAL)	9.848	(14.282)		AREA	1.043	WGT/FT	1.227
FACTOR	12	CIRCLE SIZE	1.367	INFILL VOLUME	N/A		

RXX	.664	SXX	.526	IXX	.460	CXX	.875
RYY	.556	SYX	.269	IYY	.323	CYY	1.200

HORIZONTAL RAIL 2 1/8" X 1 3/4"
STOCK DOORS

DENOTES CRITICAL DIMENSION
ALL DIES PROPERTY OF TUBELITE

REV	DATE	DESCRIPTION	INTL
A	08/23/04	1.442 WAS 1.438	CRH

DRAWN BY	DH	DRWG DATE	04/24/84	APPV'D BY		DATE APPV'D	
DWG SCALE	NOTED	PRODUCT CODE	100	E0255			
							REV
							A

E0056
C

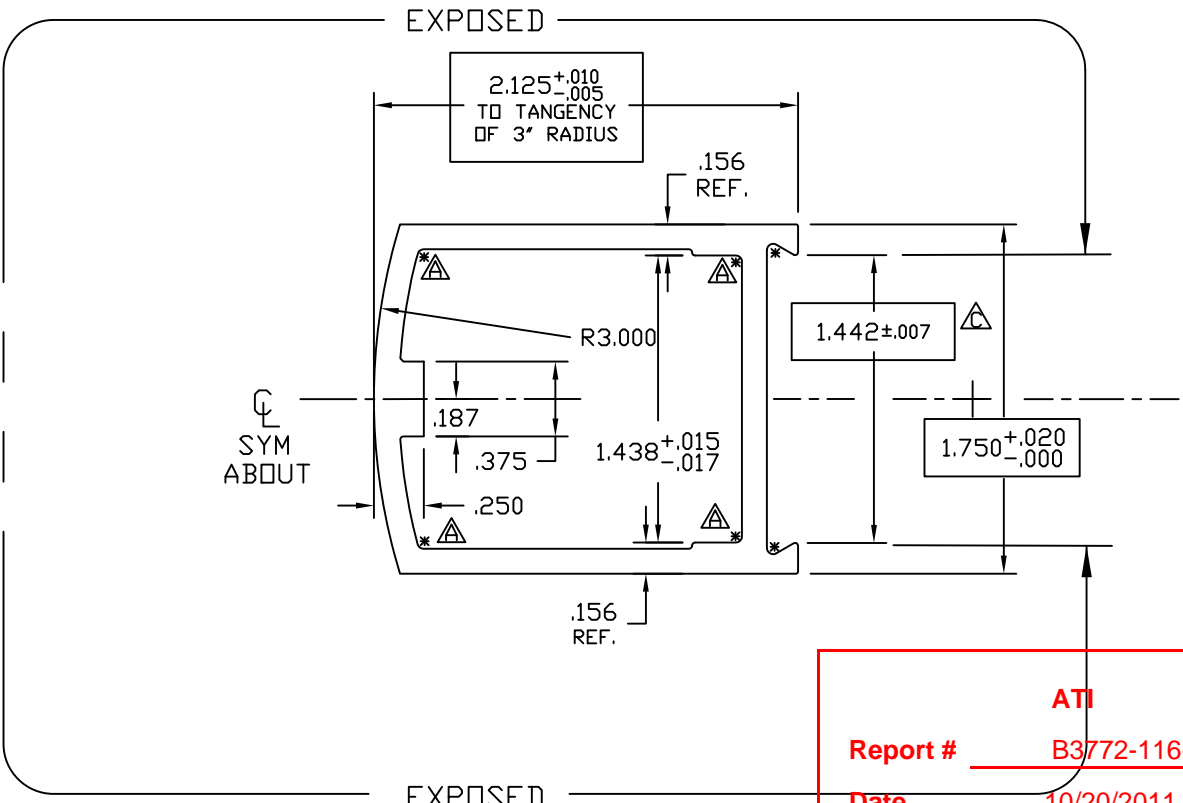

ATI

Report # B3772-116-45

Date 10/20/2011

Simulator Eric Borish

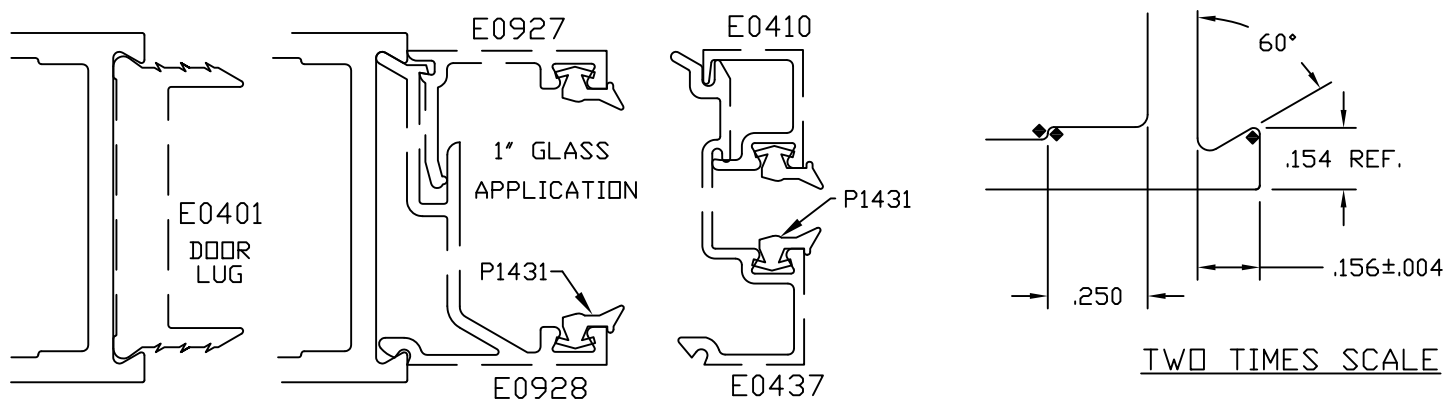

$.125 \begin{matrix} +.003 \\ -.011 \end{matrix}$ TYP WALL

SNAP FIT W/E0437(1/4"GLASS) AND E0928(1"GLASS)
 INDICATES CRITICAL DIMENSION

© 2006 TUBELITE INC. ALL RIGHTS RESERVED
 ALUMINUM ASSOCIATION STANDARD TOLERANCES APPLY UNLESS NOTED
 ALL UNSPECIFIED RADII .015
 * INDICATES .031 RADIUS

TUBELITE
 Dependable
 LEADERS IN ECO-EFFICIENT STOREFRONT, CURTAINWALL AND ENTRANCE SYSTEMS

3056 WALKER RIDGE NW, SUITE G
 WALKER, MICHIGAN 49544

WALL THK.	NOTED	SECTION CLASS	H	MAT'L	6063-T5	RATIO	60:1
PERIMETER OUT (TOTAL)	7.929(14.376)		AREA	.924	WGT/FT	1.108	
FACTOR	13	CIRCLE SIZE	2.654	INFILL VOLUME	N/A		

RXX	.662	SXX	.472	IXX	.413	CXX	.875
RYY	.747	SYY	.481	IYY	.525	CYY	1.091

DENOTES CRITICAL DIMENSION
 ALL DIES PROPERTY OF TUBELITE

REV	DATE	DESCRIPTION	INTL
A	08/23/00	1.449 WAS 1.438, ADDED .031R, UPDATED TITLE BLK	CRH
B	09/29/00	+0.005/-0.010 WAS +0.015/-0.000	CRH
C	10/14/01	±0.007 WAS +0.005/-0.010	CRH

DOOR STILE 2 1/8" X 1 3/4"
 STOCK DOORS

DRAWN BY	DH	DRWG DATE	04/04/84	APPV'D BY		DATE APPV'D	
DWG SCALE	NOTED	PRODUCT CODE	100	E0056		REV	C

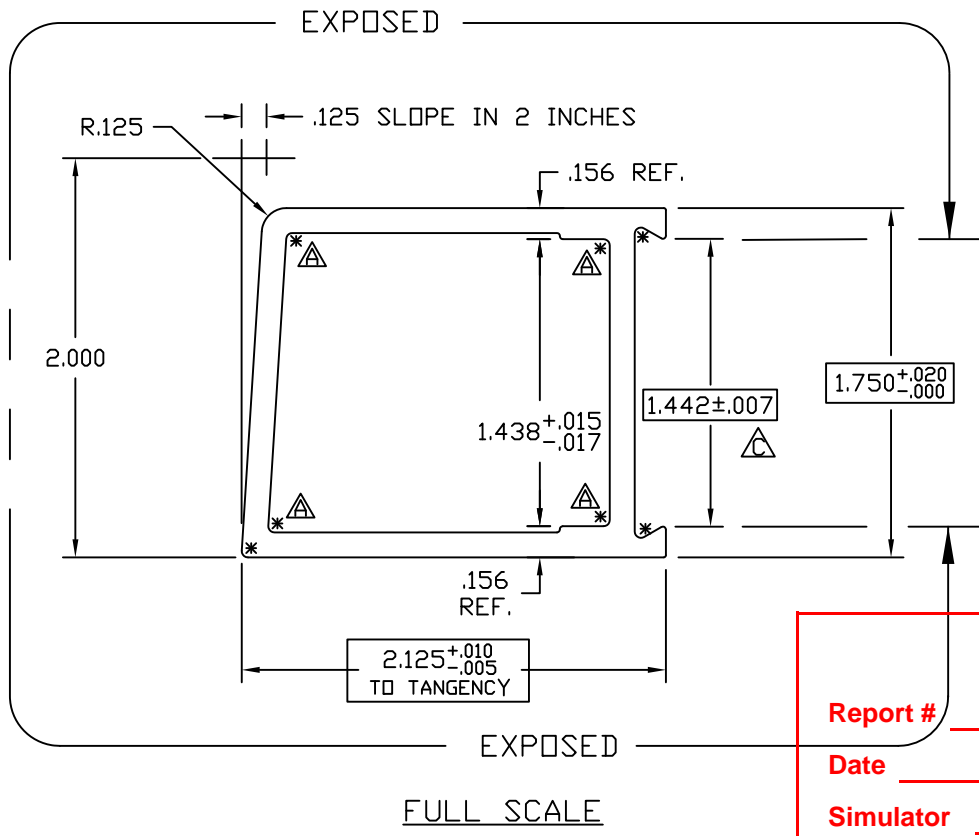

ATI

Report # B3772-116-45

Date 10/20/2011

Simulator Eric Barthe

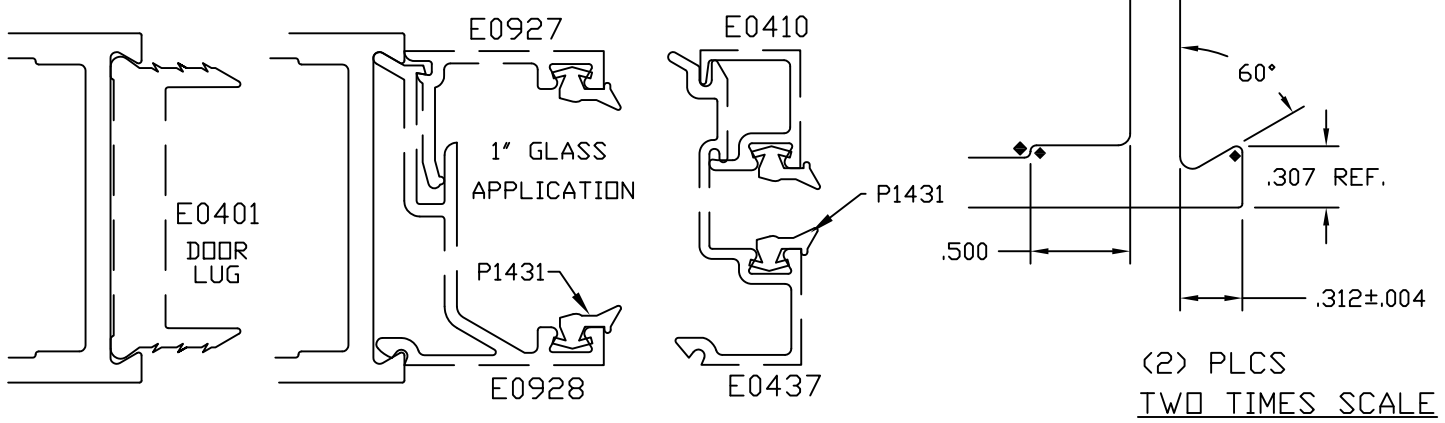

$.125 \begin{smallmatrix} +.003 \\ -.011 \end{smallmatrix}$ TYP WALL

INDICATES CRITICAL DIMENSION
SNAP FIT W/E0437(1/4"GLASS) AND E0928(1"GLASS)

© 2006 TUBELITE INC. ALL RIGHTS RESERVED
ALUMINUM ASSOCIATION STANDARD TOLERANCES APPLY UNLESS NOTED
ALL UNSPECIFIED RADII .015
* INDICATES .031 RADIUS
□ DENOTES CRITICAL DIMENSION
ALL DIES PROPERTY OF TUBELITE

TUBELITE
DEPENDABLE
LEADERS IN ECO-EFFICIENT STOREFRONT, CURTAINWALL AND ENTRANCE SYSTEMS

3056 WALKER RIDGE NW, SUITE G
WALKER, MICHIGAN 49544

WALL THK.	NOTED	SECTION CLASS	H	MAT'L	6063-T5	RATIO	61:1
PERIMETER OUT (TOTAL)	8.001(14.257)		AREA	.905	WGT/FT	1.064	
FACTOR	13	CIRCLE SIZE	2.753	INFILL VOLUME	N/A		

RXX	.680	SXX	.471	IXX	.418	CXX	.889
RYY	.738	SYX	.461	IYY	.493	CYY	1.068

DOOR STILE 2 1/8" X 2"
STOCK DOORS

REV	DATE	DESCRIPTION	INTL
A	08/23/00	1.449 WAS 1.438, ADDED .031R, UPDATED TITLE BLK	CRH
B	09/27/00	+0.005/-0.010 WAS +.015/-0.000	CRH
C	10/2/01	1.442+/-0.007 WAS 1.449+0.005/-0.010	CRH

DRAWN BY	DAT	DRWG DATE	03/31/84	APPV'D BY		DATE APPV'D	
DWG SCALE	NOTED	PRODUCT CODE	100	E0055		REV	C

E0054
C

ATI
Report # B3772-116-45
Date 10/20/2011
Simulator Eric Barthe

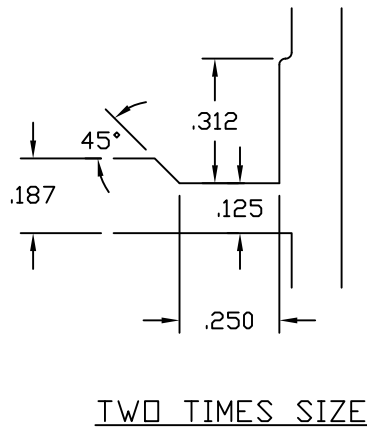
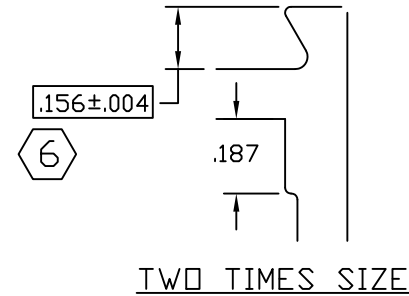
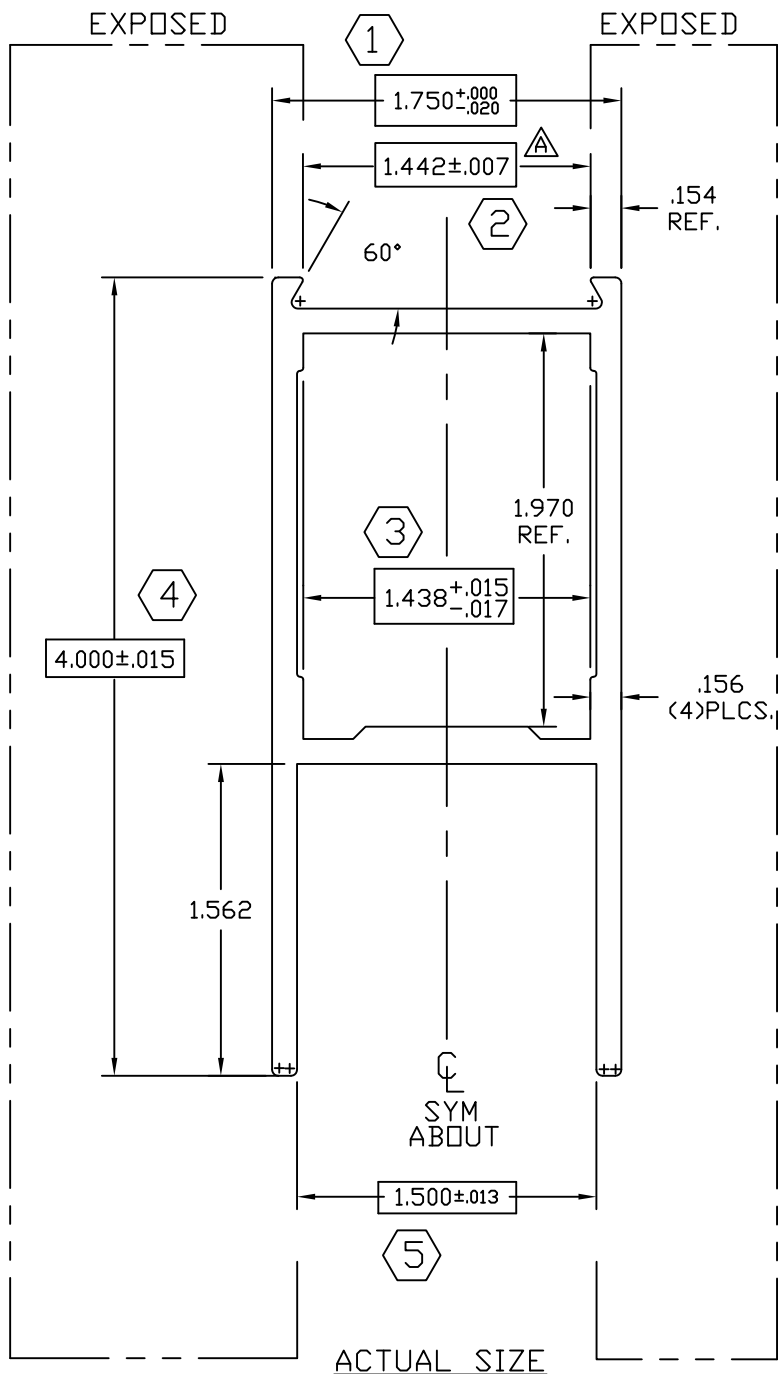

7 SNAP FIT WITH E-0437
.125 +.003 / -.011 TYP WALL UNLESS NOTED

© 2006 TUBELITE INC. ALL RIGHTS RESERVED
ALUMINUM ASSOCIATION STANDARD
TOLERANCES APPLY UNLESS NOTED
ALL UNSPECIFIED RADII .015
* INDICATES .031 RADIUS

TUBELITE
DEPENDABLE
**LEADERS IN ECO-EFFICIENT STOREFRONT,
CURTAINWALL AND ENTRANCE SYSTEMS**

3056 WALKER RIDGE NW, SUITE G
WALKER, MICHIGAN 49544

WALL THK.	NOTED	SECTION CLASS	H	MAT'L	6063-T5	RATIO	38:1
PERIMETER OUT (TOTAL)	14.972	(22.036)	AREA	1.460	WGT/FT	1.715	
FACTOR	13	CIRCLE SIZE	4.352	INFILL VOLUME	N/A		

RXX	1.153	SXX	.890	IXX	1.941	CXX	2.182
RYY	.717	SYX	.858	IYY	.751	CYY	.875

HORIZONTAL RAIL 4" X 1 3/4"
STOCK DOORS

DRAWN BY	DAT	DRWG DATE	03/31/84	APPV'D BY	DATE APPV'D	REV	C
DWG SCALE	NOTED	PRODUCT CODE	100	E0054			

REV	DATE	DESCRIPTION	INTL
A	11/22/91	REVISED CALCULATIONS	KMH
B	12/10/91	REVISED CALCULATIONS	KMH
C	4/2/02	WAS 1.438 +.01/-013	CRH

☐ DENOTES CRITICAL DIMENSION
ALL DIES PROPERTY OF TUBELITE

ATI

Report # B3772-116-45

Date 10/20/2011

Simulator Eric Barilko

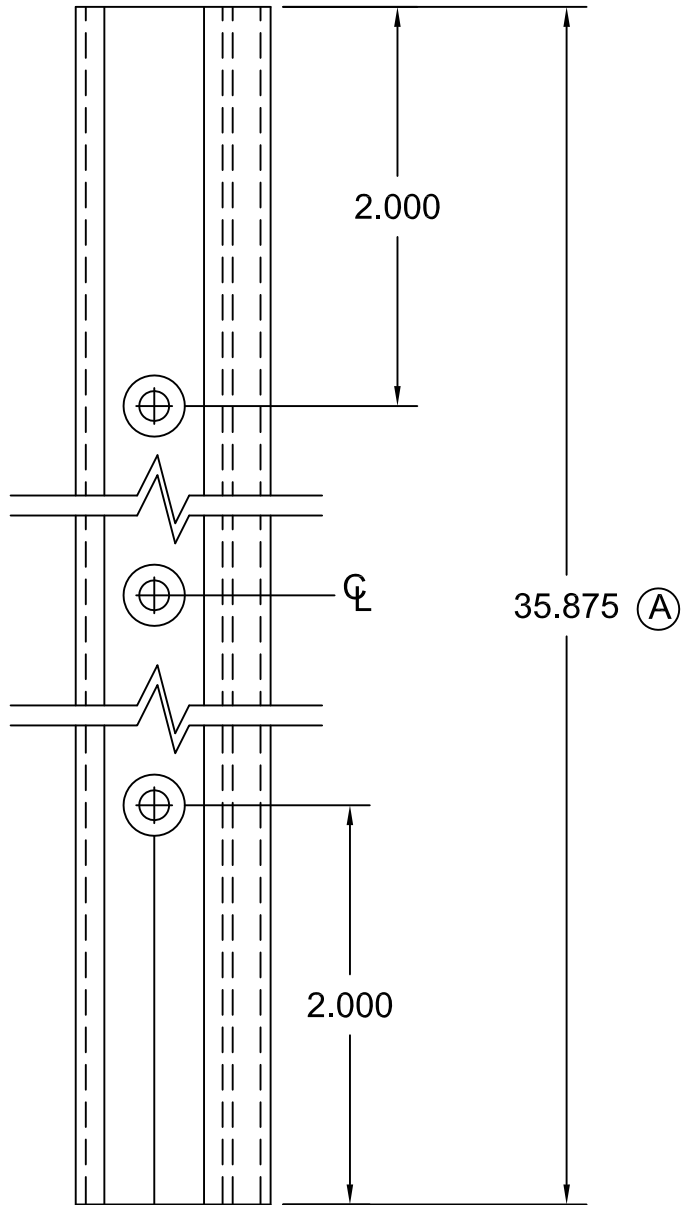

Operations:

1. Cut to length as required from E2059
2. Drill 3 holes with #25 Drl & Ctsk for S-064 (#6 FHCS)
3. Cut P-830 to length, Install, & Crimp ends
4. Cut P-914 to length, and install.
5. Paint ends as required
6. Ship with three (3) S064 Screws.

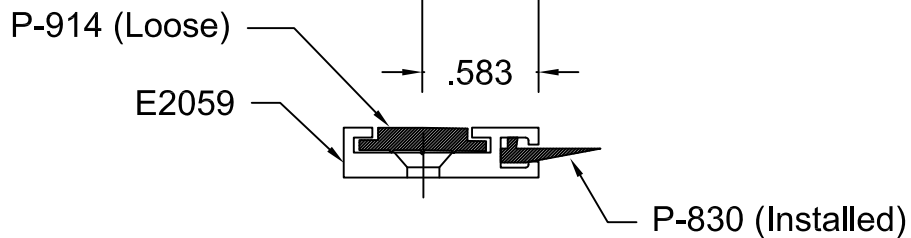

© 2006 TUBELITE INC. ALL RIGHTS RESERVED
 ALL UNSPECIFIED RADII .015
 * INDICATES .031 RADIUS
 □ DENOTES CRITICAL DIMENSION

TUBELITE®
 DEPENDABLE
 LEADERS IN ECO-EFFICIENT STOREFRONT,
 CURTAINWALL AND ENTRANCE SYSTEMS

3056 WALKER RIDGE NW, SUITE G
 WALKER, MICHIGAN 49544

REV	DATE	DESCRIPTION	INTL
	7/29/83	Released Part per ED 128	PJ
A	05/17/90	ED #1222 Dim was 34.875	KMH
B	8/24/01	Redrawn for CAD	DMT
C	06/19/03	OUTSOURCE - ADD S064 SCREWS	SRD

Door Seal to use with
E2058 Threshold

DRAWN BY PJ	DRWG DATE 05/09/83	APPV,D BY	DATE APPV'D
DRWG SCALE Full	PRODUCT CODE 380	P1275	
			REV C

P1098A

B

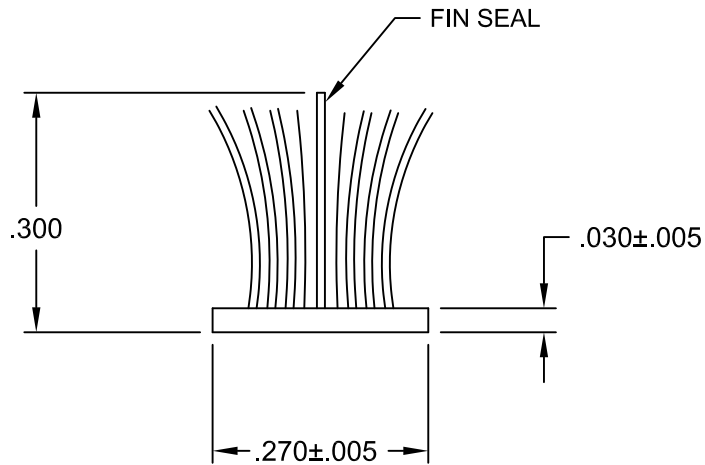

Actual Size

ATI

Report # B3772-116-45

Date 10/20/2011

Simulator Eric Bahile

© 2006 TUBELITE INC. ALL RIGHTS RESERVED

ALL UNSPECIFIED RADII .015

* INDICATES .031 RADIUS

□ DENOTES CRITICAL DIMENSION

TUBELITE®
 DEPENDABLE
 LEADERS IN ECO-EFFICIENT STOREFRONT,
 CURTAINWALL AND ENTRANCE SYSTEMS

3056 WALKER RIDGE NW, SUITE G
WALKER, MICHIGAN 49544

REV	DATE	DESCRIPTION	INTL
A	03/08/83	Release Part per ED 109	
B	05/29/02	Redrawn for CAD	DMT

Poly Bond Fin-Seal Weathering use with Door Stop E1377			
DRAWN BY	Don H	DRWG DATE	06/03/83
APPV,D BY		DATE APPV'D	
DRWG SCALE	Noted	PRODUCT CODE	380
P1098A			B

ATI

Report # B3772-116-45

Date 10/20/2011

Simulator Eric Bahila

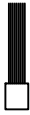

Actual Size

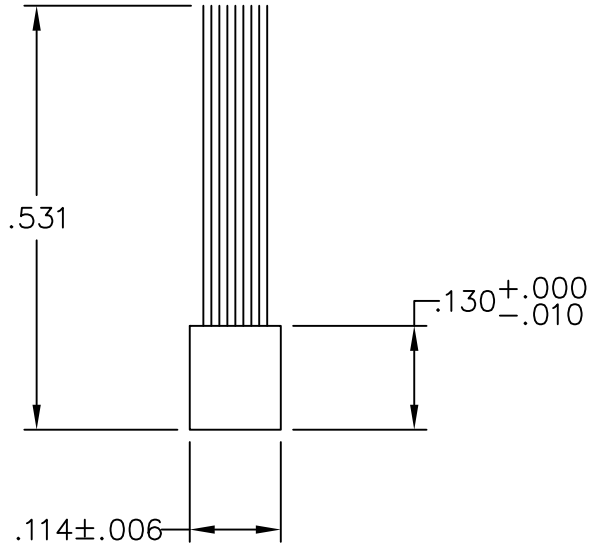

Four Times Size

Purchased Part

Schlege Pile Weathering
Part Number 364-1006-5101

© 2006 TUBELITE INC. ALL RIGHTS RESERVED

ALL UNSPECIFIED RADII .015

* INDICATES .031 RADIUS

□ DENOTES CRITICAL DIMENSION

TUBELITE®
DEPENDABLE
LEADERS IN ECO-EFFICIENT STOREFRONT,
CURTAINWALL AND ENTRANCE SYSTEMS

3056 WALKER RIDGE NW, SUITE G
WALKER, MICHIGAN 49544

REV	DATE	DESCRIPTION	INTL
A	05/03/02	Redrawn for CAD	DMT

Pile Weathering to use
with E1195 and E1152

DRAWN BY PJ	DRWG DATE 10/03/75	APPV,D BY	DATE APPV'D	REV
DRWG SCALE Noted	PRODUCT CODE 110	P938		A

ATI
 Report # B3772-116-45
 Date 10/20/2011
 Simulator Eric Bakula

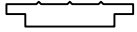

ACTUAL SIZE

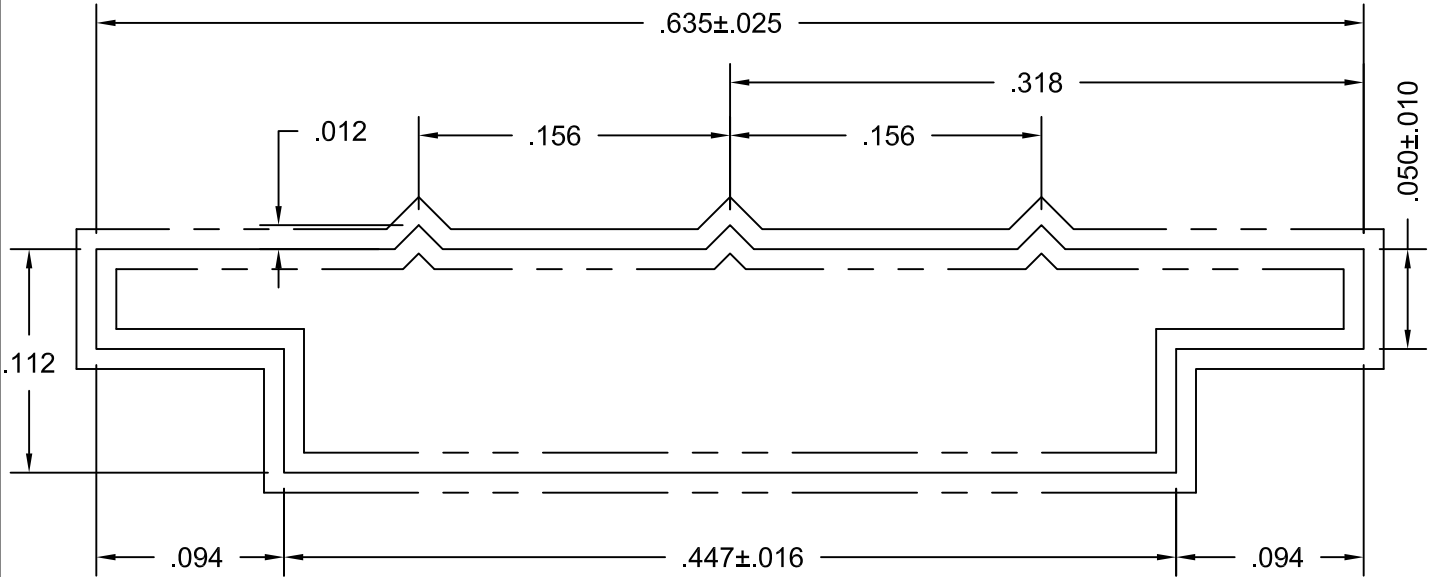

Ten Times Size

NOTE: Part to receive Silicone Bath after Extruding

Purchased Part
 Avon Rubber
 90 Durometer
 250' Rolls

© 2006 TUBELITE INC. ALL RIGHTS RESERVED

ALL UNSPECIFIED RADII .015

* INDICATES .031 RADIUS

DENOTES CRITICAL DIMENSION

TUBELITE
 DEPENDABLE
 LEADERS IN ECO-EFFICIENT STOREFRONT,
 CURTAINWALL AND ENTRANCE SYSTEMS

3056 WALKER RIDGE NW, SUITE G
 WALKER, MICHIGAN 49544

REV	DATE	DESCRIPTION	INTL
A	01/19/96	Redrawn for AutoCAD	DMT

<p>EPDM Rubber Glazing Use with M1061, M1063, M1202</p>			
DRAWN BY	KMH	DRWG DATE	01/19/96
APPV,D BY		DATE APPV'D	
DRWG SCALE	Noted	PRODUCT CODE	380
<p>P914</p>			<p>REV A</p>

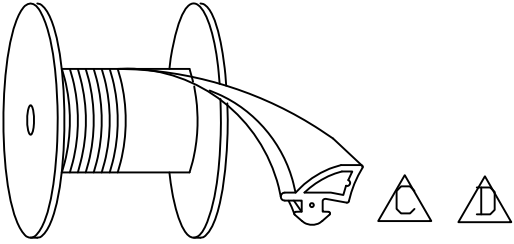

ATI

Report # B3772-116-45

Date 10/20/2011

Simulator Eric Barilko

Material must UNREEL like this...

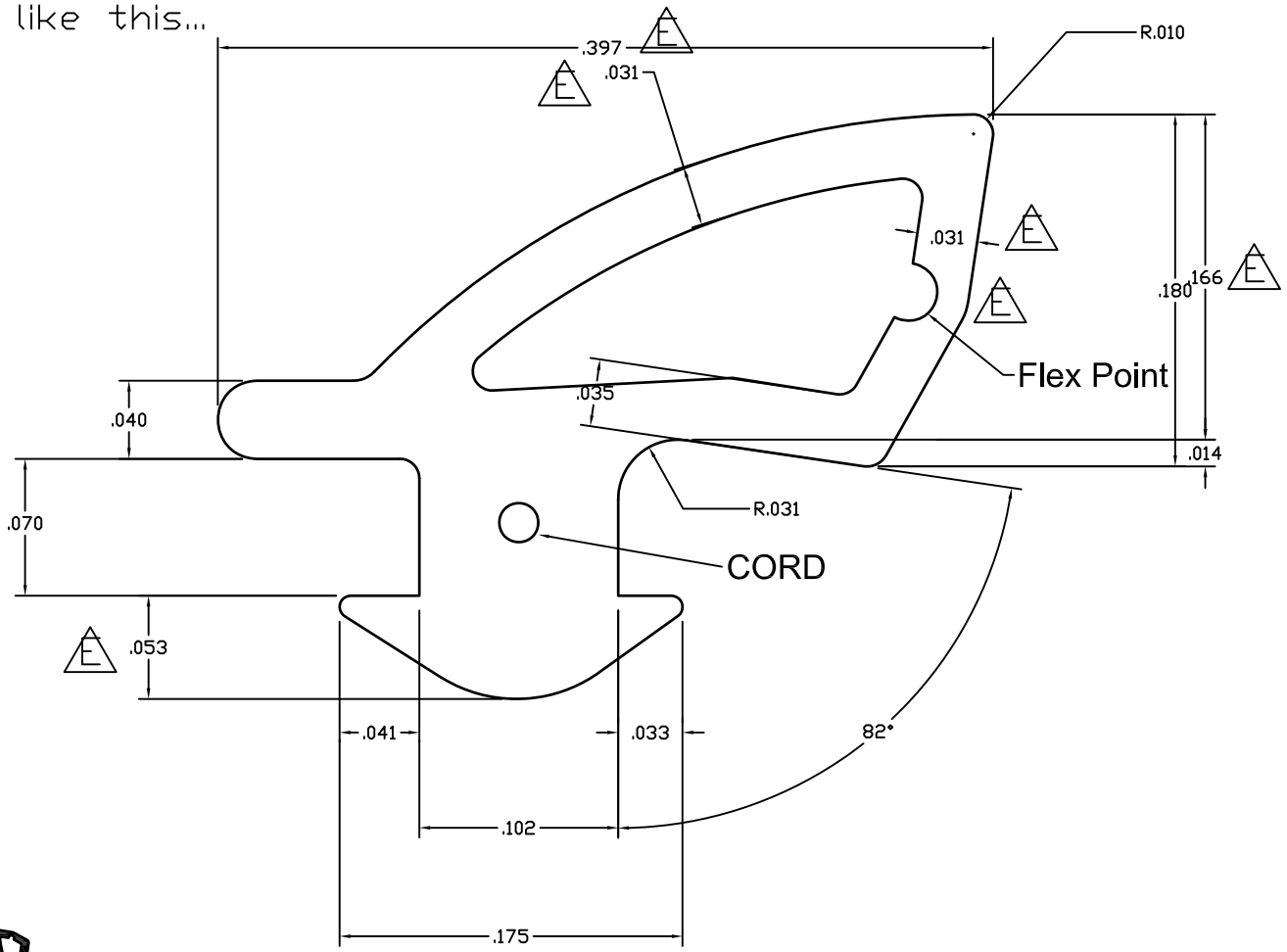

ACTUAL SIZE

MATERIAL: EPDM 60 DUROMETER WITH CORD

© 2006 TUBELITE INC. ALL RIGHTS RESERVED
 ALL UNSPECIFIED RADII .015
 * INDICATES .031 RADIUS
 □ DENOTES CRITICAL DIMENSION



3056 WALKER RIDGE NW, SUITE G
 WALKER, MICHIGAN 49544

REV	DATE	DESCRIPTION	INTL
A	08/20/07	MODIFIED DART: .070 WAS .060 AND .051 WAS .061 ADDED CORD	NIK
B	10/16/08	ADDED MANUFACTURER'S TOLERANCES FOR REFERENCE	SRD
C	10/22/10	Modified gasket position of how the reel should roll	TT
D	12/16/10	Modified gasket position of how the reel should roll	TT
E	02/15/11	Rev flex pt, thickness was .032, .180 was .188	TT

1/4"-1" DOOR GLAZING GASKET
 500' ROLLS

DRAWN BY NIK	DRWG DATE 4-17-07	APPV.D BY	DATE APPV'D
DRWG SCALE 10X	PRODUCT CODE 100	P0017	REV E

ATI

Report # B3772-116-45

Date 10/20/2011

Simulator Eric Barilko

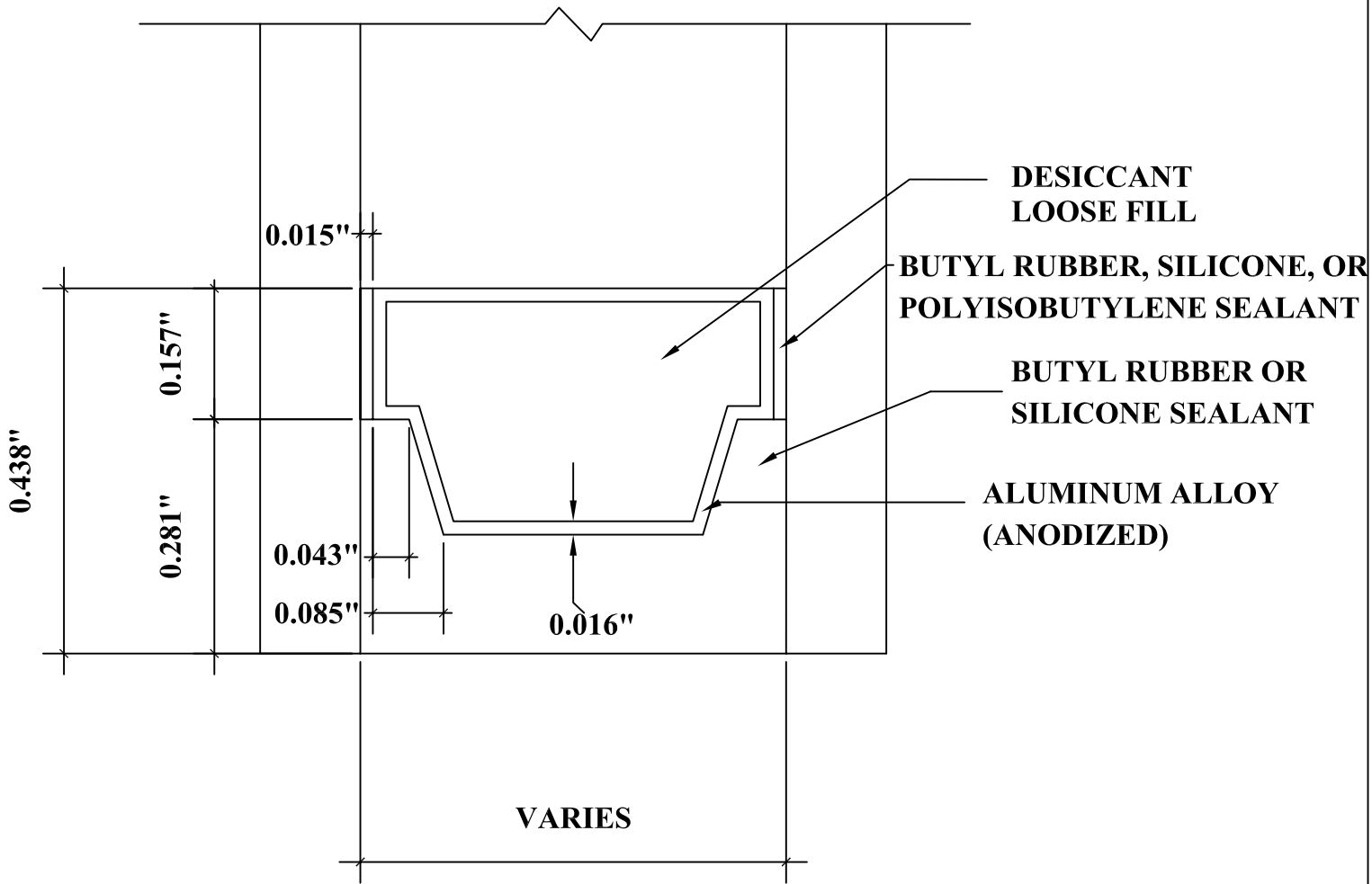

DETAIL FOR THERMAL MODELING OF
ALUMINUM SPACER (A1-D)