



AAMA 507-07 THERMAL PERFORMANCE REPORT

Rendered to:

TUBELITE, INC.

SERIES/MODEL: Standard 1-3/4" Narrow Stile Single Door

TYPE: Swinging Door - Single

Report No: B3772.18-116-45
Report Date: 10/27/11

AAMA 507-07 THERMAL PERFORMANCE REPORT

Rendered to:

TUBELITE, INC.
4878 Mackinaw Trail
Reed City, Michigan 49677

Report No: B3772.18-116-45
Report Date: 10/27/11
Simulation Date: 10/27/11

Project Summary:

Architectural Testing, Inc. was contracted by Tubelite, Inc. to provide U-Factor and Solar Heat Gain Coefficient thermal performance ratings on the Standard 1-3/4" Narrow Stile Single Door Swinging Door - Single. The thermal performance ratings were determined in accordance with AAMA 507-07, Standard Practice for Determining the Thermal Performance Characteristics of Fenestration Systems Installed in Commercial Building.

Reference Documents:

AAMA 507-07, Standard Practice for Determining the Thermal Performance Characteristics of Fenestration Systems Installed in Commercial Buildings

NFRC 100-2010, Procedure for Determining Fenestration Product U-Factors

NFRC 200-2010, Procedure for Determining Fenestration Product Solar Heat Gain Coefficient and Visible Transmittance at Normal Incidence

Simulation Specimen Description:

Series/Model: Standard 1-3/4" Narrow Stile Single Door
Product Groupings: 1-3/4" Narrow w/o sweep grouped with 1-3/4" Narrow w/ sweep.
Type: Swinging Door - Single
Frame Material: Aluminum Framing System
Material Finish: Painted Aluminum
Specimen Size: 960mm wide by 2090mm high (37-3/4" by 82-3/8")
Configuration: Single vision Ilte
Drawing Reference: Tubelite Standard Doors - 2" Frame Details

Tubelite, Inc.
Standard 1-3/4" Narrow Stile Single Door - Swinging Door - Single

System U-Factor vs. Percentage of Vision Area

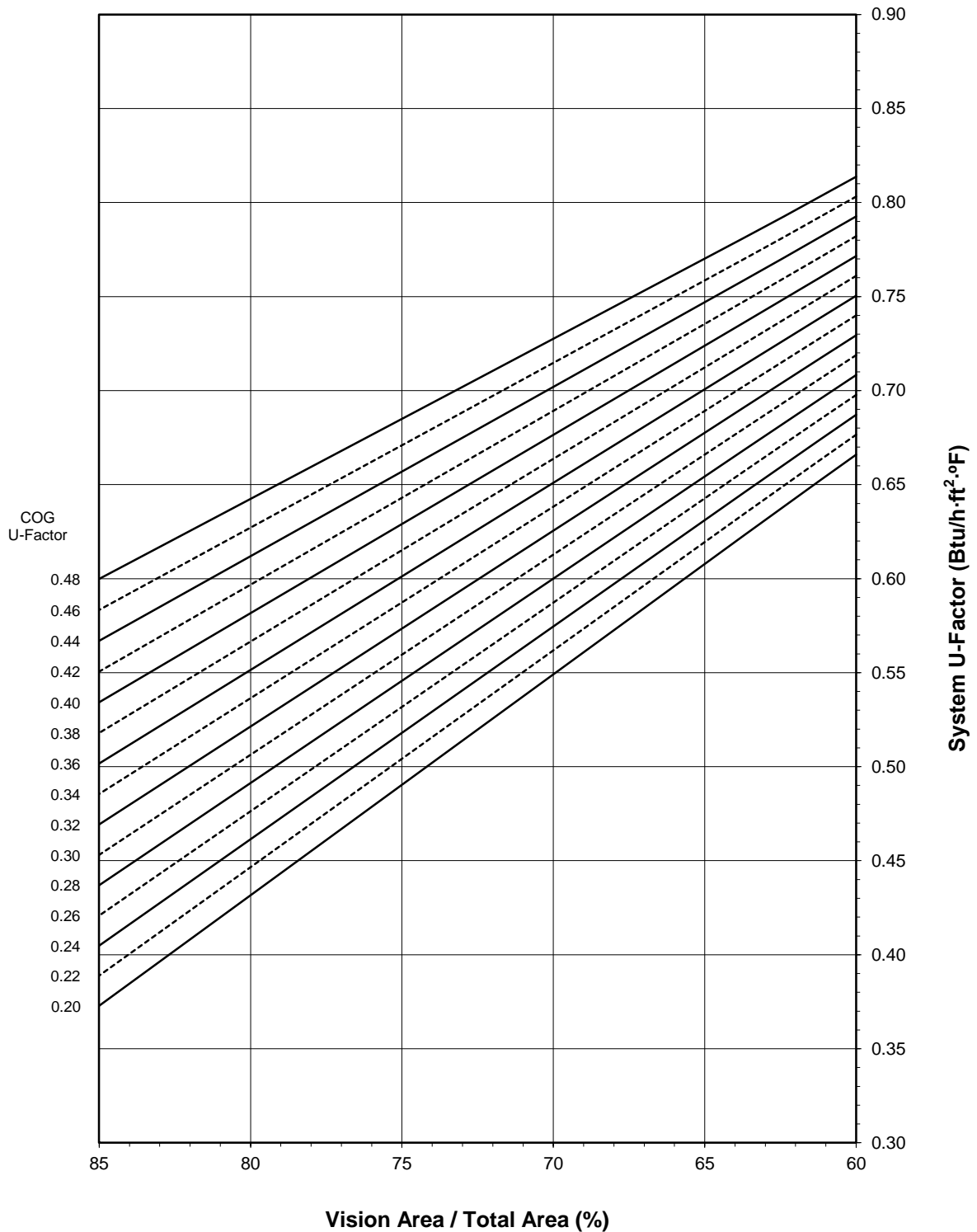

Note: 1 inch Overall - Dual Glazed Glass (0.48-0.20 COG) with Aluminum Spacer

Tubelite, Inc.
Standard 1-3/4" Narrow Stile Single Door - Swinging Door - Single

Size Specific U-Factor Matrix*

Glazing Option	Center of Glass U-Factor	Overall U-Factor
1	0.48	0.78
2	0.46	0.77
3	0.44	0.76
4	0.42	0.75
5	0.40	0.74
6	0.38	0.72
7	0.36	0.71
8	0.34	0.70
9	0.32	0.69
10	0.30	0.68
11	0.28	0.67
12	0.26	0.66
13	0.24	0.65
14	0.22	0.63
15	0.20	0.62

Note: 1 inch Overall - Dual Glazed Glass (0.48-0.20 COG) with Aluminum Spacer

Size Specific SHGC Matrix*

Center of Glass SHGC	Overall SHGC
0.75	0.51
0.70	0.48
0.65	0.45
0.60	0.42
0.55	0.38
0.50	0.35
0.45	0.32
0.40	0.29
0.35	0.26
0.30	0.23
0.25	0.19
0.20	0.16
0.15	0.13
0.10	0.10
0.05	0.07

Size Specific VT Matrix*

Center of Glass VT	Overall VT
0.75	0.48
0.70	0.45
0.65	0.41
0.60	0.38
0.55	0.35
0.50	0.32
0.45	0.29
0.40	0.25
0.35	0.22
0.30	0.19
0.25	0.16
0.20	0.13
0.15	0.10
0.10	0.06
0.05	0.03

*Size Specific U-Factor, SHGC, and VT Matrices are based on the standard Swinging Door - Single specimen size of 960mm wide by 2090mm high (37-3/4" by 82-3/8"). This represents 63.7% Vision Area / Total Area.

Vision Area Data

Option No.	COG U-Factor	COG Temperature	Cross Section	Frame Height	Frame U-Factor	Edge U-Factor	Total Product U-Factor		
							60% Vision Area	NFRC 100-2010	85% Vision Area
							33.91" by 73.82"	37.80" by 82.28"	96.81" by 210.76"
1	0.48	43.7	Head	5.0895	1.3040	0.5692	0.8138	0.7812	0.5999
			L. Jamb	5.0262	1.3073	0.5700			
			R. Jamb	5.0262	1.3073	0.5700			
			Sill	5.7770	1.2002	0.5820			
2	0.46	44.8	Head	5.0895	1.3041	0.5557	0.8032	0.7699	0.5834
			L. Jamb	5.0262	1.3073	0.5564			
			R. Jamb	5.0262	1.3073	0.5564			
			Sill	5.7770	1.2001	0.5684			
3	0.44	45.8	Head	5.0895	1.3041	0.5423	0.7926	0.7587	0.5670
			L. Jamb	5.0262	1.3074	0.5430			
			R. Jamb	5.0262	1.3074	0.5430			
			Sill	5.7770	1.1999	0.5548			
4	0.42	46.8	Head	5.0895	1.3042	0.5290	0.7821	0.7474	0.5506
			L. Jamb	5.0262	1.3075	0.5297			
			R. Jamb	5.0262	1.3075	0.5297			
			Sill	5.7770	1.1998	0.5413			
5	0.40	47.9	Head	5.0895	1.3043	0.5157	0.7716	0.7361	0.5343
			L. Jamb	5.0262	1.3076	0.5165			
			R. Jamb	5.0262	1.3076	0.5165			
			Sill	5.7770	1.1996	0.5279			
6	0.38	48.9	Head	5.0895	1.3043	0.5027	0.7610	0.7249	0.5180
			L. Jamb	5.0262	1.3077	0.5034			
			R. Jamb	5.0262	1.3077	0.5034			
			Sill	5.7770	1.1995	0.5147			
7	0.36	50.0	Head	5.0895	1.3044	0.4895	0.7505	0.7136	0.5017
			L. Jamb	5.0262	1.3078	0.4903			
			R. Jamb	5.0262	1.3078	0.4903			
			Sill	5.7770	1.1993	0.5014			
8	0.34	51.0	Head	5.0895	1.3045	0.4766	0.7400	0.7023	0.4855
			L. Jamb	5.0262	1.3079	0.4777			
			R. Jamb	5.0262	1.3079	0.4777			
			Sill	5.7770	1.1992	0.4884			
9	0.32	52.0	Head	5.0895	1.3046	0.4636	0.7294	0.6910	0.4693
			L. Jamb	5.0262	1.3080	0.4646			
			R. Jamb	5.0262	1.3080	0.4646			
			Sill	5.7770	1.1991	0.4752			
10	0.30	53.1	Head	5.0895	1.3047	0.4507	0.7189	0.6797	0.4532
			L. Jamb	5.0262	1.3082	0.4518			
			R. Jamb	5.0262	1.3082	0.4518			
			Sill	5.7770	1.1990	0.4623			

Vision Area Data

Option No.	COG U-Factor	COG Temperature	Cross Section	Frame Height	Frame U-Factor	Edge U-Factor	Total Product U-Factor		
							60% Vision Area	NFRC 100-2010	85% Vision Area
							33.91" by 73.82"	37.80" by 82.28"	96.81" by 210.76"
11	0.28	54.2	Head	5.0895	1.3048	0.4378	0.7083	0.6684	0.4370
			L. Jamb	5.0262	1.3083	0.4389			
			R. Jamb	5.0262	1.3083	0.4389			
			Sill	5.7770	1.1988	0.4492			
12	0.26	55.2	Head	5.0895	1.3049	0.4250	0.6977	0.6570	0.4209
			L. Jamb	5.0262	1.3084	0.4260			
			R. Jamb	5.0262	1.3084	0.4260			
			Sill	5.7770	1.1987	0.4363			
13	0.24	56.3	Head	5.0895	1.3050	0.4122	0.6872	0.6457	0.4049
			L. Jamb	5.0262	1.3085	0.4132			
			R. Jamb	5.0262	1.3085	0.4132			
			Sill	5.7770	1.1986	0.4234			
14	0.22	57.3	Head	5.0895	1.3051	0.3996	0.6765	0.6343	0.3890
			L. Jamb	5.0262	1.3086	0.4008			
			R. Jamb	5.0262	1.3086	0.4008			
			Sill	5.7770	1.1974	0.4094			
15	0.20	58.4	Head	5.0895	1.3053	0.3868	0.6659	0.6230	0.3729
			L. Jamb	5.0262	1.3088	0.3880			
			R. Jamb	5.0262	1.3088	0.3880			
			Sill	5.7770	1.1973	0.3965			

Detailed drawings, datasheets, representative samples of test specimens, a copy of this report, or other pertinent project documentation will be retained by Architectural Testing, Inc. for a period of four years from the original test date. At the end of this retention period such materials shall be discarded without notice and the service life of this report by Architectural Testing will expire. Results obtained are simulated values and were secured by using the designated test methods. This report does not constitute certification of this product nor an opinion or endorsement by this laboratory. It is the exclusive property of the client named herein and relates only to the specimen(s) simulated. This report may not be reproduced, except in full, without the written approval of Architectural Testing, Inc.

For ARCHITECTURAL TESTING, INC.:

SIMULATED BY:

REVIEWED BY:

Eric Barilar
Simulation Technician

Kevin S. Louder
Project Engineer

EAB:EAB
B3772.18-116-45

Attachments (pages): This report is complete only when all attachments listed are included.

Appendix A: Drawings and Bills of Material (23)

Revision Log

<u>Rev. #</u>	<u>Date</u>	<u>Page(s)</u>	<u>Revision(s)</u>
.01R0	10/27/2011	All	Original Report Issue

All drawings and Bills of Material used in simulating this product are enclosed in this Appendix.

STANDARD SINGLE DOOR BOM -1.75 Frame

ATI	
Report #	<u>B3772-116-45</u>
Date	<u>10/20/2011</u>
Simulator	<u><i>Eric Barilan</i></u>

FRAME:

Description	QTY	Length	Part number	Material
4500 Jamb 1.3/4" x 4 1/2"	2	82 3/8"	E4544	
Header 1 3/4" x 4 1/2"	1	34 1/4"	E45124	
	1	34 7/23"		
Header Door stops & Jambs	2	80 5/8"	E4531	
Weather pile	30 ft		P1098A	
closure open back plate	2		E4543	

DOOR:

Description	QTY	Length	Narrow P/N	Medium P/N	Wide P/N	Material
Beveled Door Stiles	2	79 13/16"	E0055 - 2 1/8"	E0086- 4"	E0416 - 5"	
Door Top Rail	1	29 13/16"	E0255- 2 1/8"	E0054- 4"	E0318 - 5"	
Top Rail Lug	2		P168	P031	P339	AL
Door Botom Rail	1	29 13/16"	E0054- 4"	E0419- 6 1/2"	E0419- 6 1/2"	
Bottom Rail Lug	2		P031	P341	P341	AL
Top Rail & Bottom Rail Tie Rods	2	33 1/4"	P020B	P020	P020	Steel
Washer for Tie Rods	4		P852	P853	P853	steel/AL
Hex nuts for Tie rods	4		S071A	S071A	S071A	Steel
Exterior Glass Stop 1" glass	4		E0927	E0927	E0927	
Interior Glass Stop 1" glass	4		E0928	E0928	E0928	
Gasket	35.42		P0017	P0017	P0017	
Adjutable Wedge Setting Bldk	2		P1911	P1911	P1911	Polypropylene
Self Adhesive Setting Bldk	3		P1912	P1912	P1912	EPDM
Threshold	1		E0019	E0019	E0019	
Threshold clip	2		P679	P679	P679	AL

MATERIAL:

E - All E part numbers are AL extrusions

Standard Doors - Single 1.75" Jamb detail Elevations & 1/4 Size Details

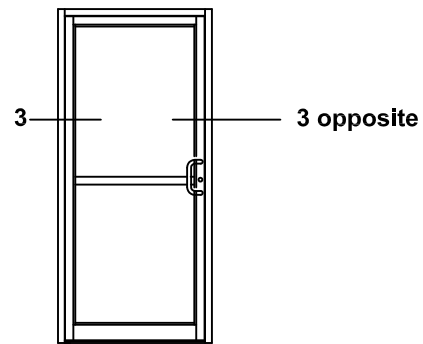

	ATI
Report #	<u>B3772-116-45</u>
Date	<u>10/20/2011</u>
Simulator	<u><i>Eric Borillo</i></u>

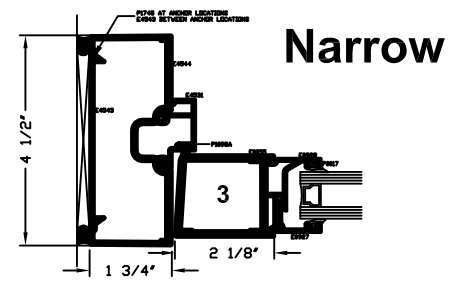
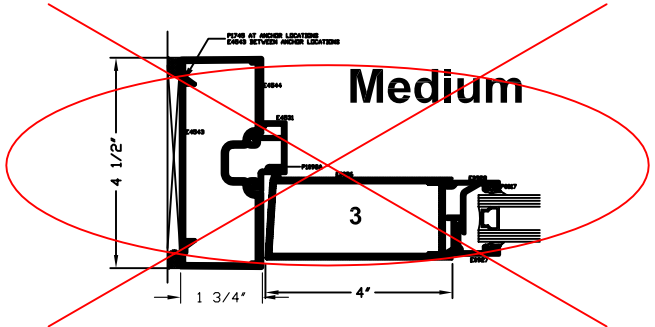
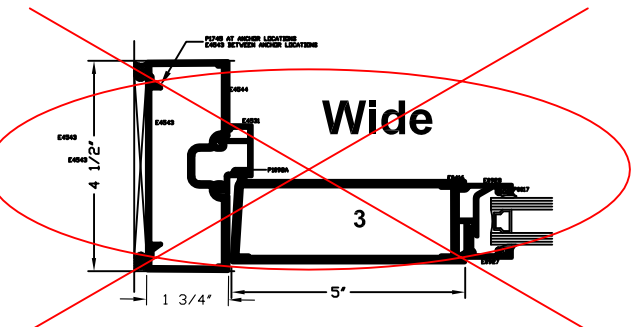

*SEALANT, ROD, & ANCHORS NOT BY TUBELITE

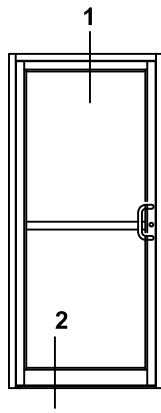

Standard Doors - Single 1.75 frame Elevations & 1/4 Size Details

ATI

Report # B3772-116-45

Date 10/20/2011

Simulator Eric Barilko

Wide

Medium

Narrow

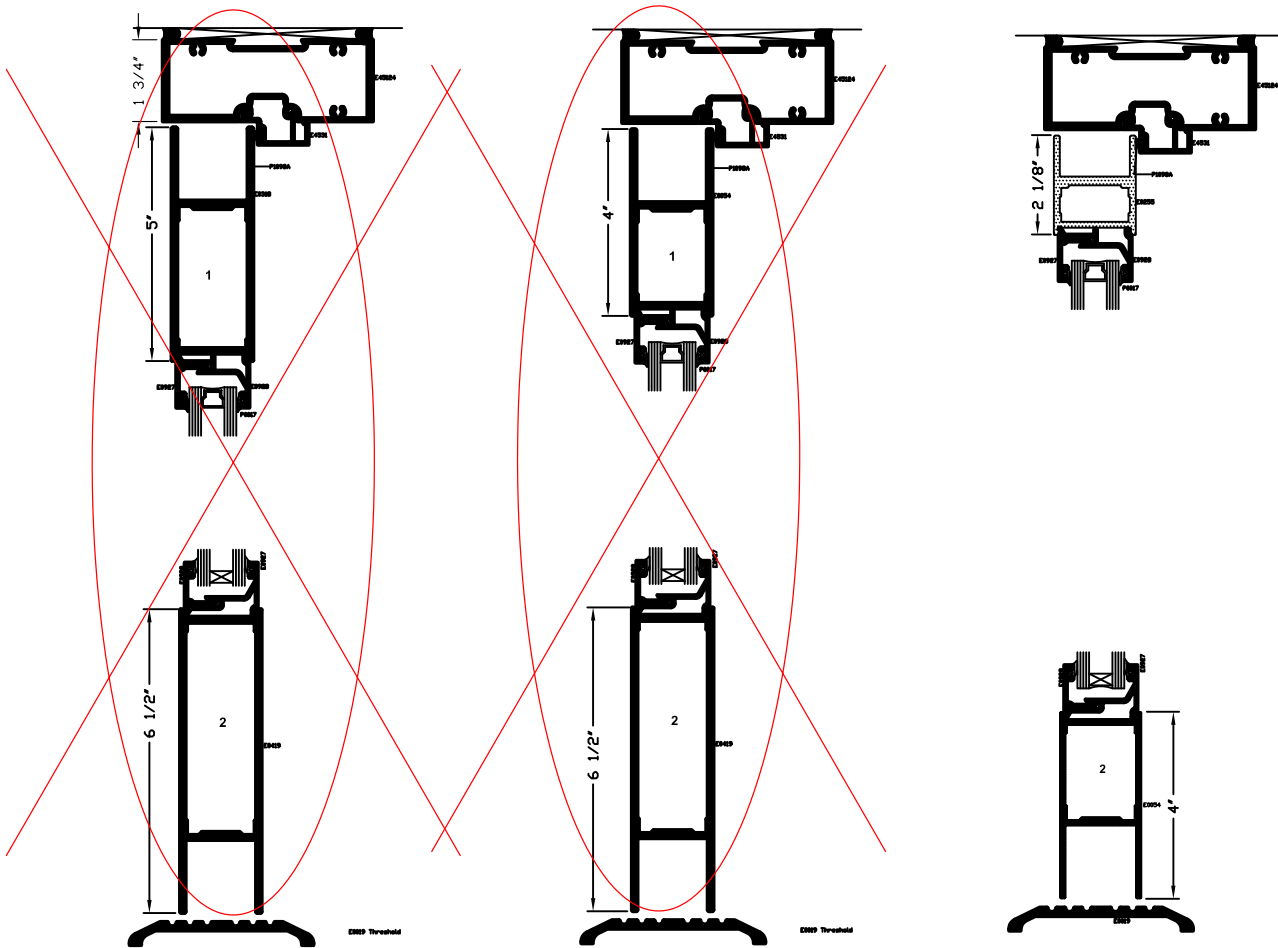

*SEALANT, ROD, & ANCHORS NOT BY TUBELITE

ATI

Report # B3772-116-45

Date 10/20/2011

Simulator Eric Bahille

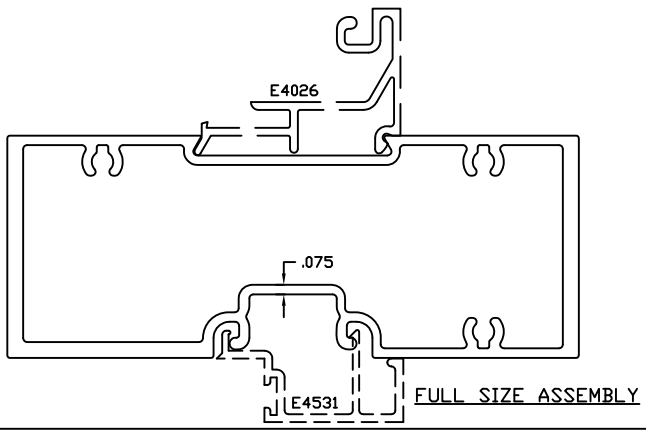
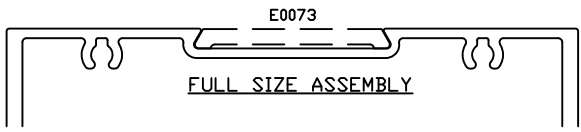
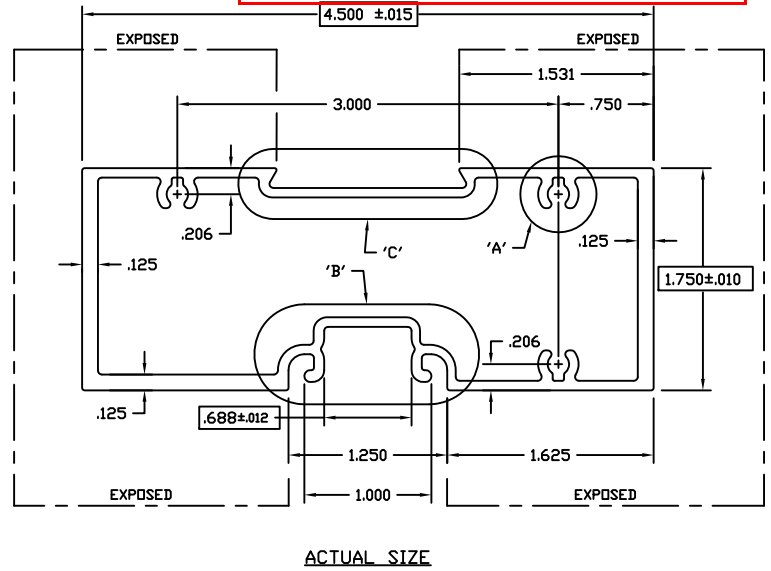
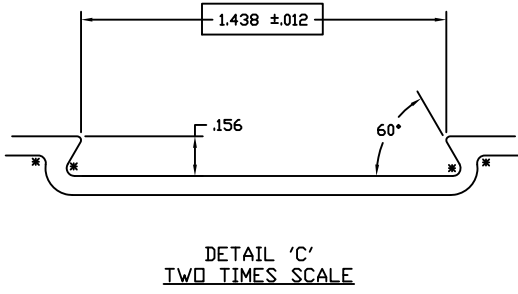
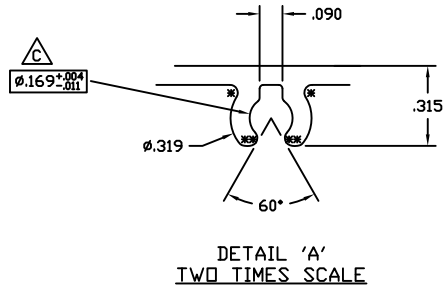
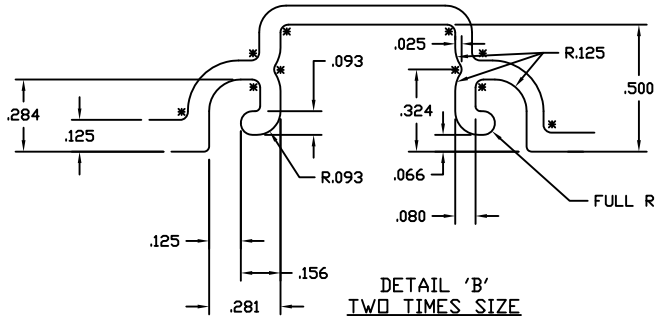

 INDICATES CRITICAL DIMENSION

©2006 TUBELITE INC. ALL RIGHTS RESERVED
ALUMINUM ASSOCIATION STANDARD TOLERANCES APPLY UNLESS NOTED
ALL UNSPECIFIED RADII .015
* INDICATES .031 RADIUS
□ DENOTES CRITICAL DIMENSION
ALL DIES PROPERTY OF TUBELITE

TUBELITE
LEADER IN ECO-FRIENDLY OPERATING CURTAINWALL AND ENTRANCE SYSTEMS

3056 WALKER RIDGE NW, SUITE G
WALKER, MICHIGAN 49544

WALL THK	.075	SECTION H CLASS	MAT'L	6063-T5	RATIO	40:1	
PERIMETER DUT (TOTAL)	14.791(29.991)	AREA	1.392	WGT/FT	1.637		
FACTOR	19	CIRCLE SIZE	4.828	INT'L VOLUME	N/A		
RXX	1.589	SXX	1.539	IXX	3.516	CXX	2.285
RYY	.678	SYY	.701	IYY	.639	CYY	.913

**DOOR HEADER 1 3/4" X 4 1/2"
E4500 STOREFRONT**

DRAWN BY	SRD	DRWG DATE	12/08/02	APPV'D BY		DATE APPV'D	
DWG SCALE	NOTED	PRODUCT CODE	160		E45124	REV	C

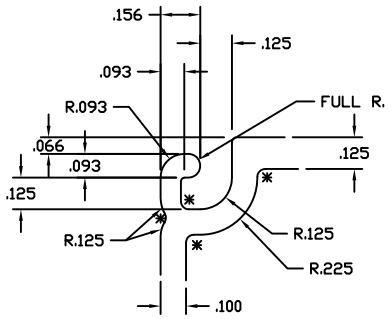

DETAIL 'A'
TWO TIMES SIZE

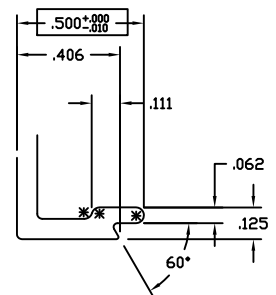

DETAIL 'B'
TWO TIMES SIZE

ATI

Report # B3772-116-45

Date 10/20/2011

Simulator Eric Barilko

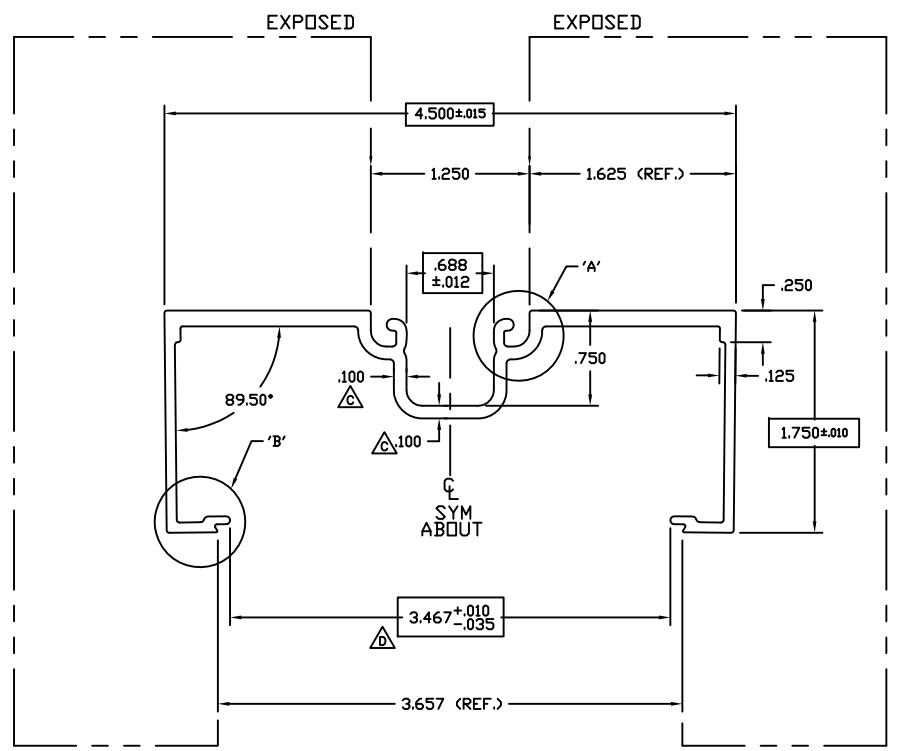

FULL SIZE

INDICATES CRITICAL DIMENSION

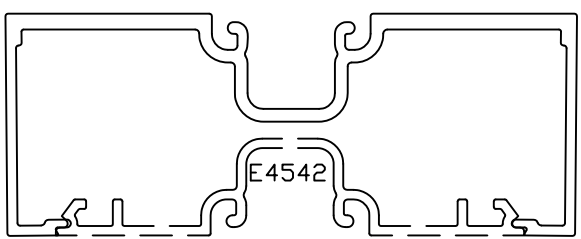

ASSEMBLY

© 2006 TUBELITE INC. ALL RIGHTS RESERVED
ALUMINUM ASSOCIATION STANDARD TOLERANCES APPLY UNLESS NOTED

TUBELITE
SUPERDURABLE
LEADING IN ECO-FRIENDLY OPERATING CURTAINWALL AND ENTRANCE SYSTEMS

3056 WALKER RIDGE NW, SUITE G
WALKER, MICHIGAN 49544

WALL THK	.080	SECTION CLASS	S	MAT'L	6063-T5	RATIO	53:1
PERIMETER OUT (TOTAL)	20.704	AREA	1.030	WGT/FT	1.211		
FACTOR	17	CIRCLE SIZE	4.802	INTELL VOLUME	N/A		
RXX	1.577	SXX	1.139	IXX	2.562	CXX	2.250
RYY	.543	SYY	.245	IYY	.304	CYY	1.241

DENOTES CRITICAL DIMENSION
 ALL DIES PROPERTY OF TUBELITE

REV	DATE	DESCRIPTION	INTL
ED2933	6-26-97	REV. .125 WALL CONTINUOUS	SRK
A	03/07/03	REVISED GL POCKET AND REGLET - REDUCED WEIGHT	SRD
	03/07/03	RENAMED E912C14 - RELEASE FOR PRODUCTION	SRD
B	03/17/04	REVISED WALL THICKNESS IN POCKET AREA AND LEGS	CRH
C	04/08/04	REVISED WALL THICKNESS IN POCKET AREA	CRH
D	03/28-07	REDUCED OPENING FOR BETTER FIT	NIK

OPEN BACK FRAME 1 3/4" X 4 1/2"
E4500 STOREFRONT

DRAWN BY	SRD	DRWG DATE	12/08/02	APPV'D BY		DATE APPV'D	
BWG SCALE	NOTED	PRODUCT CODE	160	E4544			

E4531

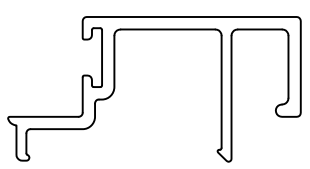
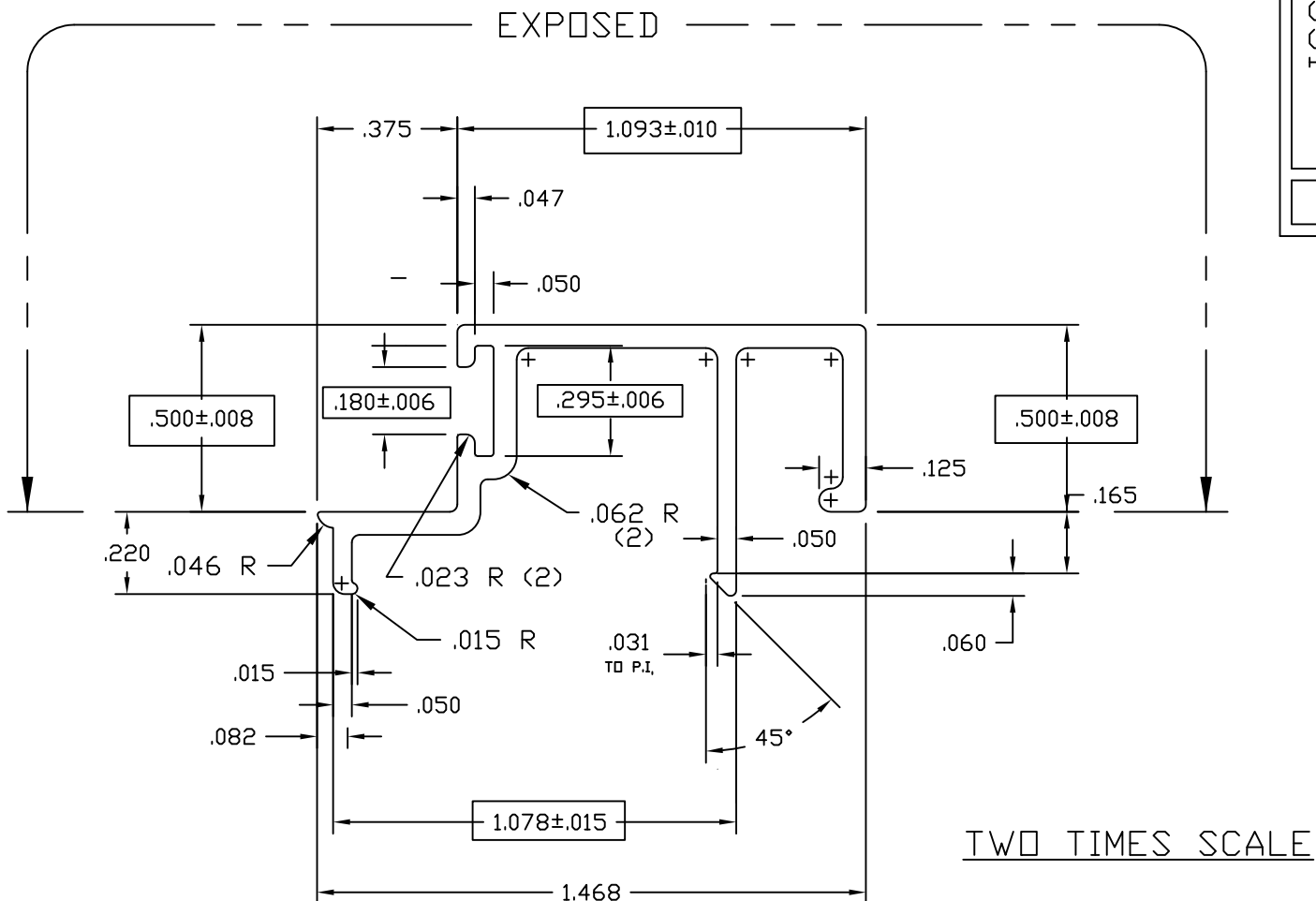

ACTUAL SIZE

ATI

Report # B3772-116-45

Date 10/20/2011

Simulator Eric Baidin

USED WITH 4500 SERIES
REPLACES E-4510
USE WITH P-1098A WEATHERING

© 2006 TUBELITE INC. ALL RIGHTS RESERVED
ALUMINUM ASSOCIATION STANDARD
TOLERANCES APPLY UNLESS NOTED
ALL UNSPECIFIED RADII .015
* INDICATES .031 RADIUS

TUBELITE®
DEPENDABLE
LEADERS IN ECO-EFFICIENT STOREFRONT,
CURTAINWALL AND ENTRANCE SYSTEMS

3056 WALKER RIDGE NW, SUITE G
WALKER, MICHIGAN 49544

WALL THK.	.062	SECTION CLASS	S	MAT'L	6063-T5	RATIO	90
PERIMETER OUT (TOTAL)	6.966	AREA	.203	WGT/FT	.238		
FACTOR	29	CIRCLE SIZE	1.58	INFILL VOLUME	N/A		

RXX	.446	SXX	.049	IXX	.040	CXX	.824
RYY	.218	SYX	.021	IYY	.010	CYY	.461

DOOR STOP 1/2" X 1 3/32"
E4500 STOREFRONT

DRAWN BY	LS	DRWG DATE	02/07/85	APPV'D BY		DATE APPV'D	
DWG SCALE	NOTED	PRODUCT CODE	160	E4531		REV	

REV	DATE	DESCRIPTION	INTL
	3/28/94	UPDATED SECTION PROPERTIES	TPB
	4/12/99	UPDATED EXPOSED	JEK

☐ DENOTES CRITICAL DIMENSION
ALL DIES PROPERTY OF TUBELITE

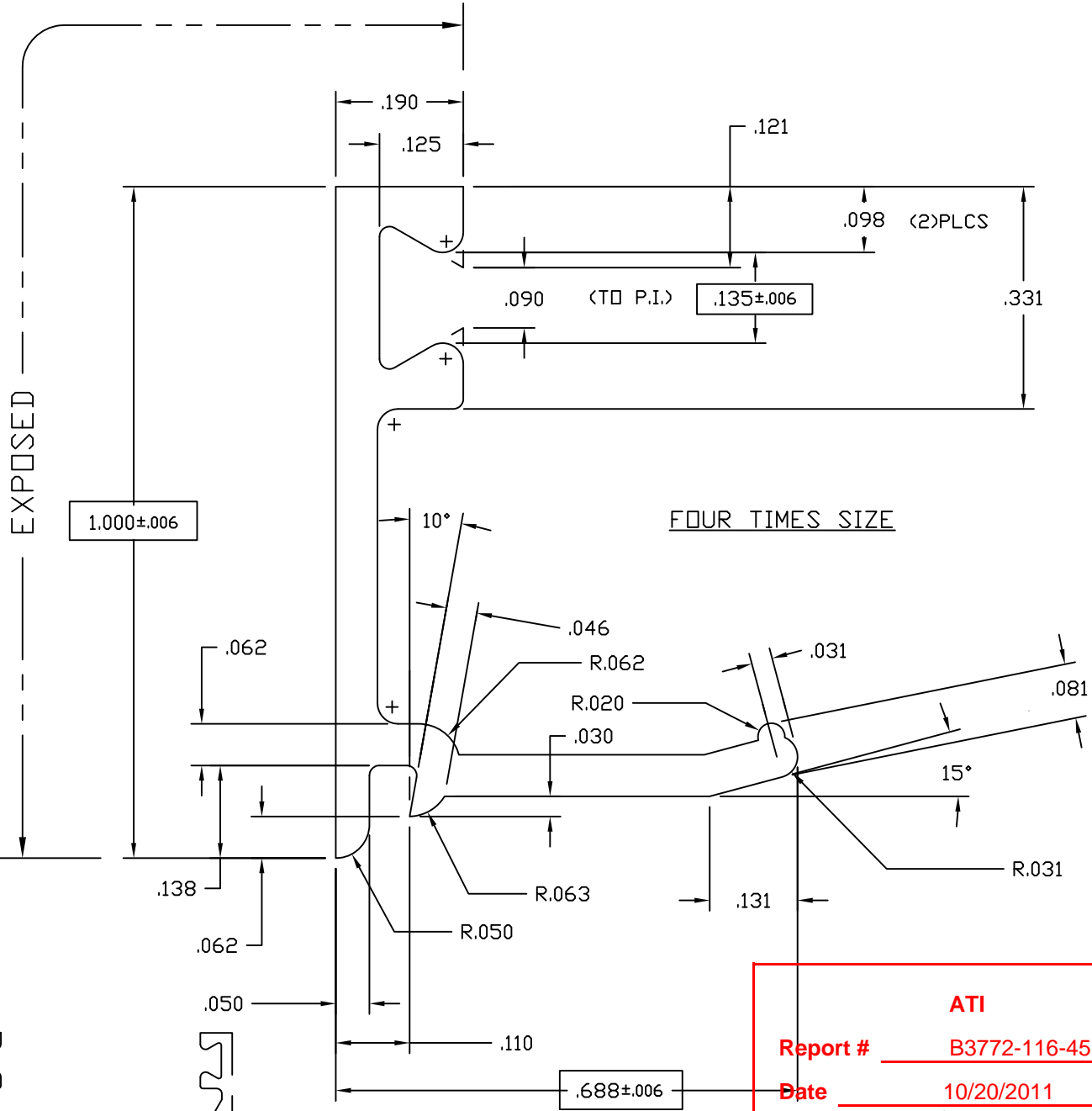

FOUR TIMES SIZE

FULL SIZE

ATI

Report # B3772-116-45

Date 10/20/2011

Simulator Eric Barthe

NOTES:

- 1) USE WITH 1" INSULATED GLASS OR 1" PANEL
- 2) USE GLAZING BEAD P-302 BOTH SIDES
- 3) USE WITH E-0928 OR E-0929

© 2006 TUBELITE INC. ALL RIGHTS RESERVED
 ALUMINUM ASSOCIATION STANDARD TOLERANCES APPLY UNLESS NOTED
 ALL UNSPECIFIED RADII .015
 * INDICATES .031 RADIUS



3056 WALKER RIDGE NW, SUITE G
 WALKER, MICHIGAN 49544

WALL THK.	.062	SECTION CLASS	S	MAT'L	6063-T5	RATIO	74:1
PERIMETER OUT (TOTAL)	4.001	AREA	.124	WGT/FT	.146		
FACTOR	27	CIRCLE SIZE	1.120	INFILL VOLUME	N/A		

RXX	.321	SXX	.023	IXX	.013	CXX	.321
RYY	.185	SYY	.008	IYY	.004	CYY	.185

GLASS STOP, 1" HIGH FOR 1" GLASS
 STOCK DOORS

DRAWN BY	CRH	DRWG DATE	04/21/99	APPV'D BY		DATE APPV'D	
DWG SCALE	NOTED	PRODUCT CODE	100	E0927		REV	

REV	DATE	DESCRIPTION	INTL
X	xx/xx/xx	xxxxxxxxxxxxxx	xxx

☐ DENOTES CRITICAL DIMENSION
 ALL DIES PROPERTY OF TUBELITE

E0255

A

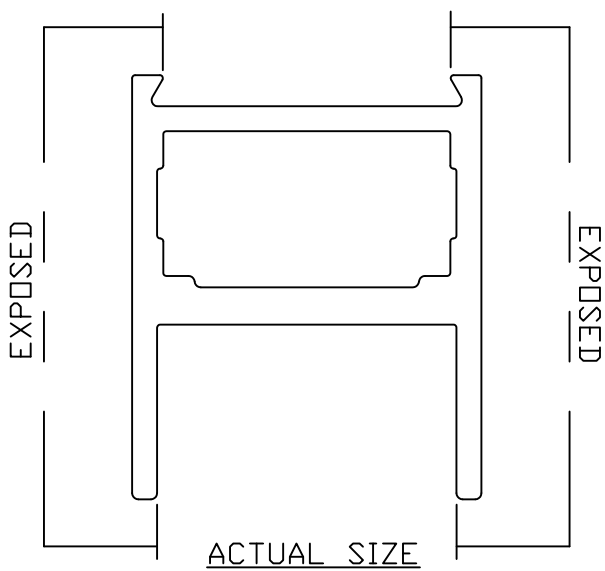
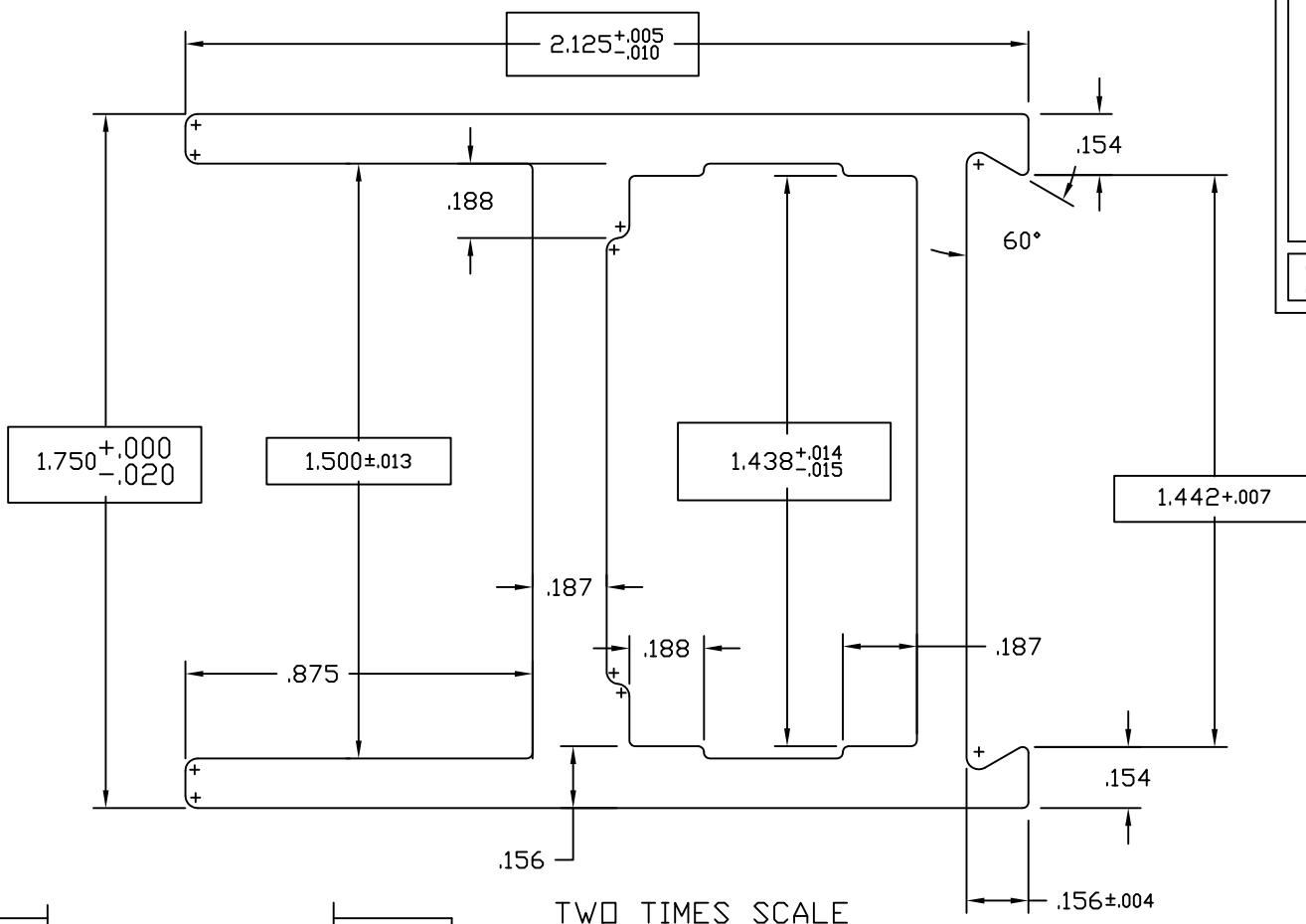

ATI

Report # B3772-116-45

Date 10/20/2011

Simulator Eric Barilak

.125 +.003/-0.011 TYP WALL THICKNESS

INDICATES CRITICAL DIMENSION

SNAP FIT W/E-0437

+ INDICATES .031 RAD (10 PLCS)

© 2006 TUBELITE INC. ALL RIGHTS RESERVED
 ALUMINUM ASSOCIATION STANDARD
 TOLERANCES APPLY UNLESS NOTED
 ALL UNSPECIFIED RADII .015
 * INDICATES .031 RADIUS

TUBELITE
 DEPENDABLE
 LEADERS IN ECO-EFFICIENT STOREFRONT,
 CURTAINWALL AND ENTRANCE SYSTEMS

3056 WALKER RIDGE NW, SUITE G
 WALKER, MICHIGAN 49544

WALL THK.	NOTED	SECTION CLASS	H	MAT'L	6063-T5	RATIO	53:1
PERIMETER OUT (TOTAL)	9.848(14.282)	AREA	1.043	WGT/FT	1.227		
FACTOR	12	CIRCLE SIZE	1.367	INFILL VOLUME	N/A		

RXX	.664	SXX	.526	IXX	.460	CXX	.875
RYY	.556	SYX	.269	IYY	.323	CYY	1.200

HORIZONTAL RAIL 2 1/8" X 1 3/4"
 STOCK DOORS

DRAWN BY	DH	DRWG DATE	04/24/84	APPV'D BY		DATE APPV'D	
DWG SCALE	NOTED	PRODUCT CODE	100	E0255		REV	A

REV	DATE	DESCRIPTION	INTL
A	08/23/04	1.442 WAS 1.438	CRH

EXPOSED

EXPOSED

ACTUAL SIZE

TWO TIMES SCALE

E0055
C

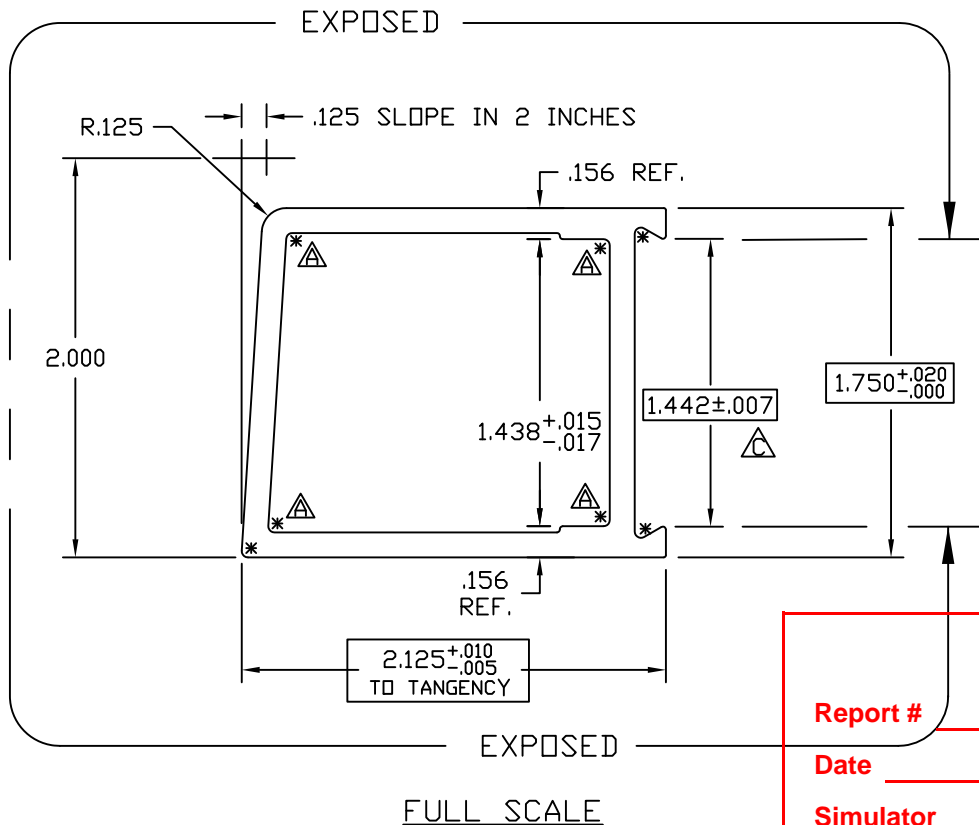

ATI
Report # B3772-116-45
Date 10/20/2011
Simulator Eric Borde

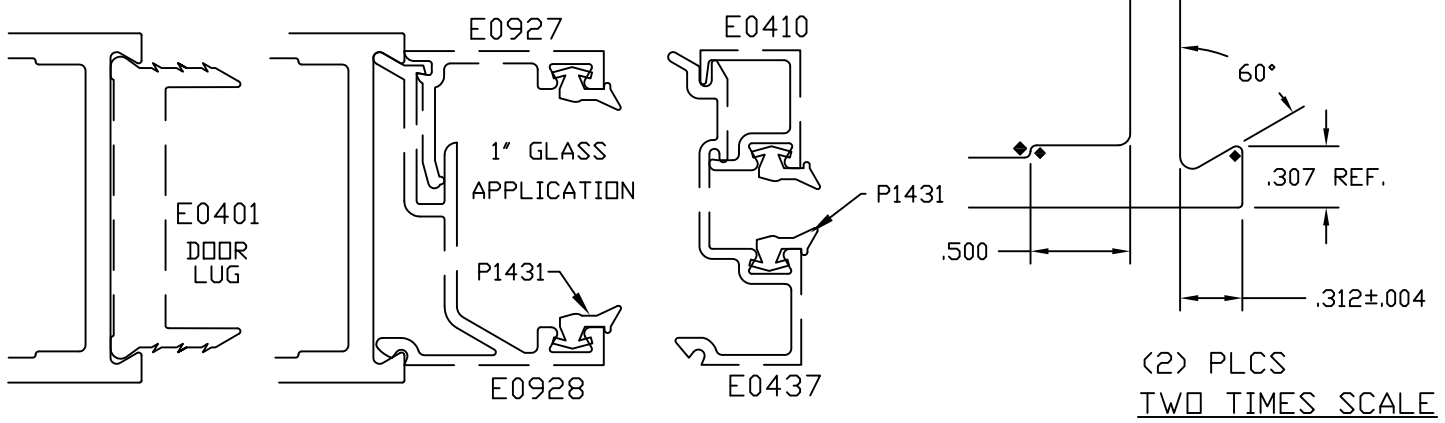

$.125 \begin{smallmatrix} +.003 \\ -.011 \end{smallmatrix}$ TYP WALL

INDICATES CRITICAL DIMENSION
 SNAP FIT W/E0437(1/4"GLASS) AND E0928(1"GLASS)

© 2006 TUBELITE INC. ALL RIGHTS RESERVED
 ALUMINUM ASSOCIATION STANDARD
 TOLERANCES APPLY UNLESS NOTED
 ALL UNSPECIFIED RADII .015
 * INDICATES .031 RADIUS

TUBELITE
 DEPENDABLE
 LEADERS IN ECO-EFFICIENT STOREFRONT,
 CURTAINWALL AND ENTRANCE SYSTEMS

3056 WALKER RIDGE NW, SUITE G
 WALKER, MICHIGAN 49544

WALL THK.	NOTED	SECTION CLASS	H	MAT'L	6063-T5	RATIO	61:1
PERIMETER OUT (TOTAL)	8.001(14.257)	AREA	.905	WGT/FT	1.064		
FACTOR	13	CIRCLE SIZE	2.753	INFILL VOLUME	N/A		

RXX	.680	SXX	.471	IXX	.418	CXX	.889
RYY	.738	SYX	.461	IYY	.493	CYY	1.068

DOOR STILE 2 1/8" X 2"
 STOCK DOORS

REV	DATE	DESCRIPTION	INTL
A	08/23/00	1.449 WAS 1.438, ADDED .031R, UPDATED TITLE BLK	CRH
B	09/27/00	+0.005/-0.010 WAS +.015/-0.000	CRH
C	10/2/01	1.442+/-0.007 WAS 1.449+0.005/-0.010	CRH

DRAWN BY	DAT	DRWG DATE	03/31/84	APPV'D BY		DATE APPV'D	
DWG SCALE	NOTED	PRODUCT CODE	100	E0055		REV	C

E0054
C

ATI
Report # B3772-116-45
Date 10/20/2011
Simulator Eric Barilko

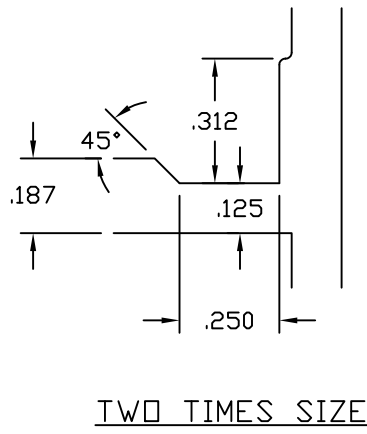
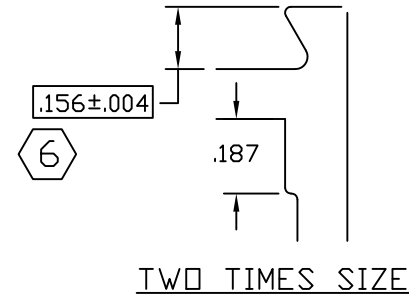
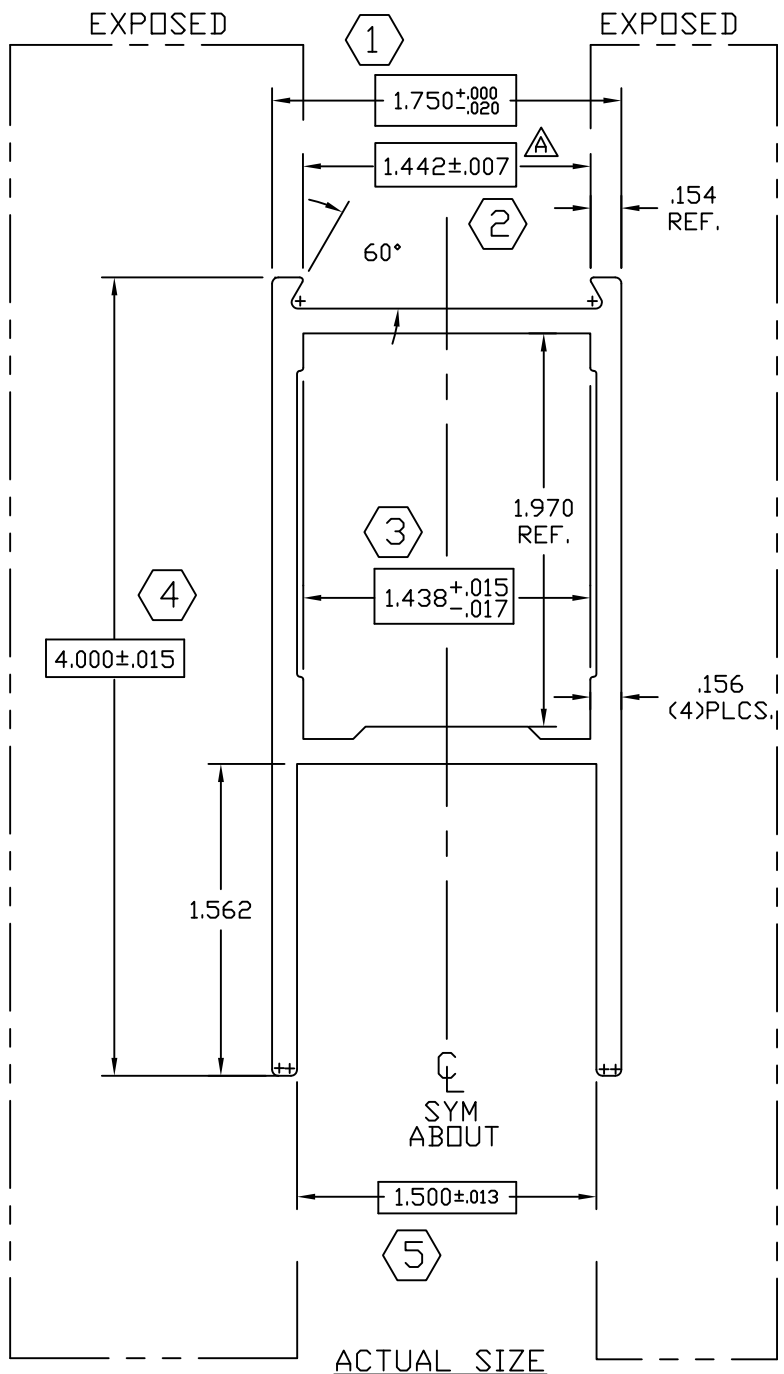

7 SNAP FIT WITH E-0437
 .125 +.003 / -.011 TYP WALL UNLESS NOTED

© 2006 TUBELITE INC. ALL RIGHTS RESERVED
 ALUMINUM ASSOCIATION STANDARD
 TOLERANCES APPLY UNLESS NOTED
 ALL UNSPECIFIED RADII .015
 * INDICATES .031 RADIUS

TUBELITE
 DEPENDABLE
 LEADERS IN ECO-EFFICIENT STOREFRONT,
 CURTAINWALL AND ENTRANCE SYSTEMS

3056 WALKER RIDGE NW, SUITE G
 WALKER, MICHIGAN 49544

WALL THK.	NOTED	SECTION CLASS	H	MAT'L	6063-T5	RATIO	38:1
PERIMETER OUT (TOTAL)	14.972	(22.036)	AREA	1.460	WGT/FT	1.715	
FACTOR	13	CIRCLE SIZE	4.352	INFILL VOLUME	N/A		

RXX	1.153	SXX	.890	IXX	1.941	CXX	2.182
RYY	.717	SYX	.858	IYY	.751	CYY	.875

HORIZONTAL RAIL 4" X 1 3/4"
 STOCK DOORS

DRAWN BY	DAT	DRWG DATE	03/31/84	APPV'D BY	DATE APPV'D	REV	C
DWG SCALE	NOTED	PRODUCT CODE	100	E0054			

DENOTES CRITICAL DIMENSION
 ALL DIES PROPERTY OF TUBELITE

REV	DATE	DESCRIPTION	INTL
A	11/22/91	REVISED CALCULATIONS	KMH
B	12/10/91	REVISED CALCULATIONS	KMH
C	4/2/02	WAS 1.438 +.01/-013	CRH

ATI
Report # B3772-116-45
Date 10/20/2011
Simulator Eric Bakula

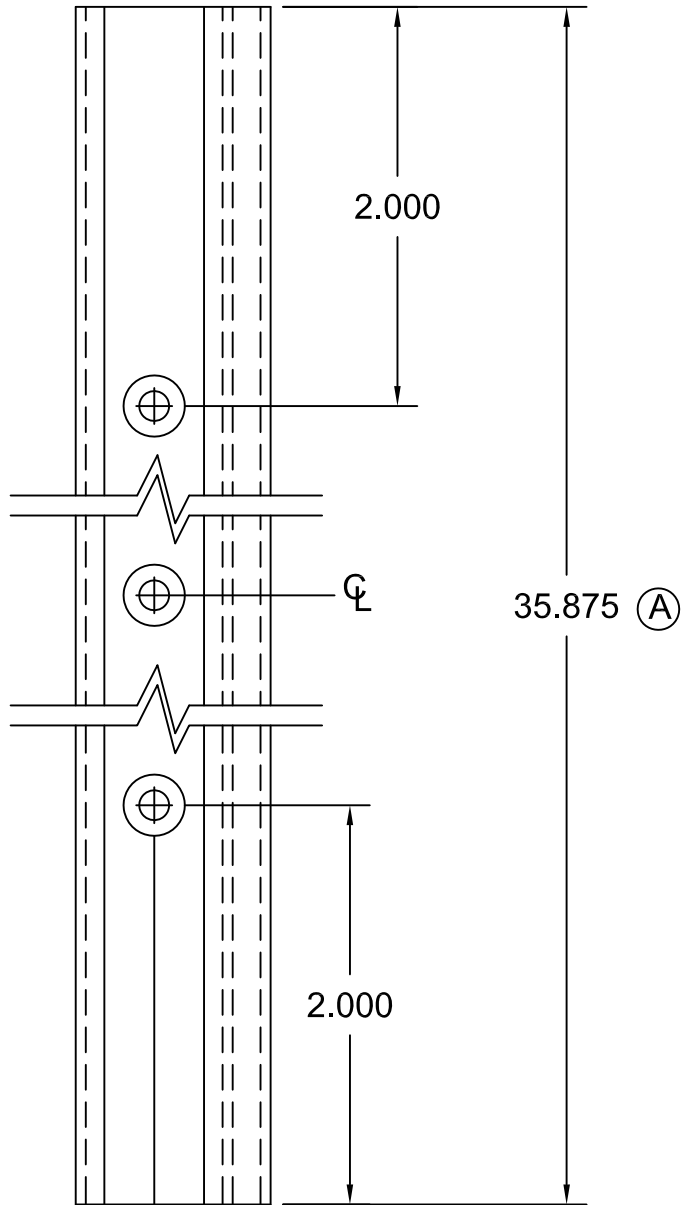

Operations:

1. Cut to length as required from E2059
2. Drill 3 holes with #25 Drl & Ctsk for S-064 (#6 FHCS)
3. Cut P-830 to length, Install, & Crimp ends
4. Cut P-914 to length, and install.
5. Paint ends as required
6. Ship with three (3) S064 Screws.

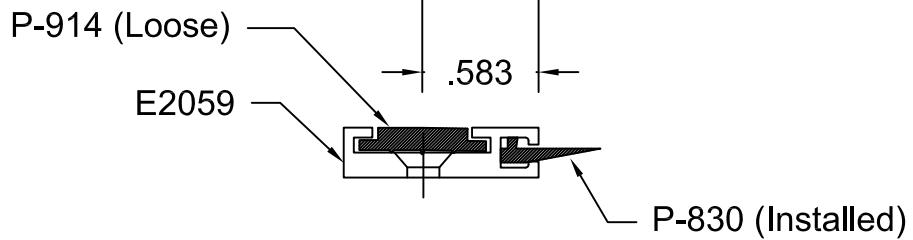

© 2006 TUBELITE INC. ALL RIGHTS RESERVED
 ALL UNSPECIFIED RADII .015
 * INDICATES .031 RADIUS
 □ DENOTES CRITICAL DIMENSION

TUBELITE®
 DEPENDABLE
 LEADERS IN ECO-EFFICIENT STOREFRONT,
 CURTAINWALL AND ENTRANCE SYSTEMS

3056 WALKER RIDGE NW, SUITE G
 WALKER, MICHIGAN 49544

REV	DATE	DESCRIPTION	INTL
	7/29/83	Released Part per ED 128	PJ
A	05/17/90	ED #1222 Dim was 34.875	KMH
B	8/24/01	Redrawn for CAD	DMT
C	06/19/03	OUTSOURCE - ADD S064 SCREWS	SRD

Door Seal to use with
 E2058 Threshold

DRAWN BY PJ	DRWG DATE 05/09/83	APPV,D BY	DATE APPV'D	REV
DRWG SCALE Full	PRODUCT CODE 380	P1275		C

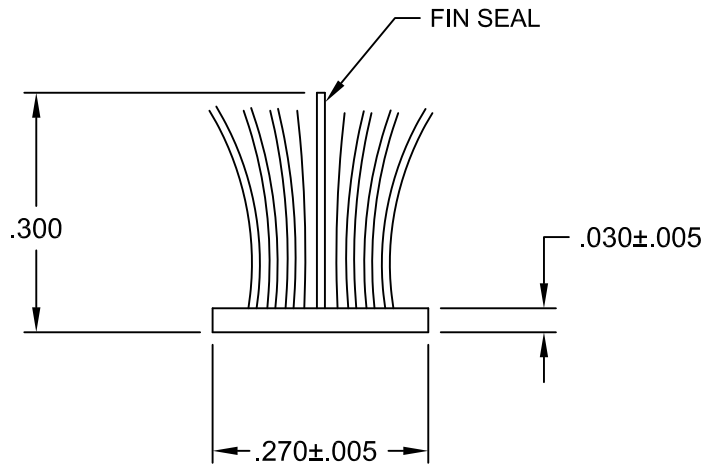

Actual Size

ATI

Report # B3772-116-45

Date 10/20/2011

Simulator Eric Bakula

© 2006 TUBELITE INC. ALL RIGHTS RESERVED

ALL UNSPECIFIED RADII .015

* INDICATES .031 RADIUS

DENOTES CRITICAL DIMENSION

TUBELITE®
DEPENDABLE
 LEADERS IN ECO-EFFICIENT STOREFRONT,
 CURTAINWALL AND ENTRANCE SYSTEMS

3056 WALKER RIDGE NW, SUITE G
 WALKER, MICHIGAN 49544

REV	DATE	DESCRIPTION	INTL
A	03/08/83	Release Part per ED 109	
B	05/29/02	Redrawn for CAD	DMT

<p>Poly Bond Fin-Seal Weathering use with Door Stop E1377</p>			
DRAWN BY	Don H	DRWG DATE	06/03/83
APPV,D BY		DATE APPV'D	
DRWG SCALE	Noted	PRODUCT CODE	380
<p>P1098A</p>			<p>B</p>

ATI
Report # B3772-116-45
Date 10/20/2011
Simulator Eric Baribe

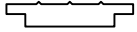

ACTUAL SIZE

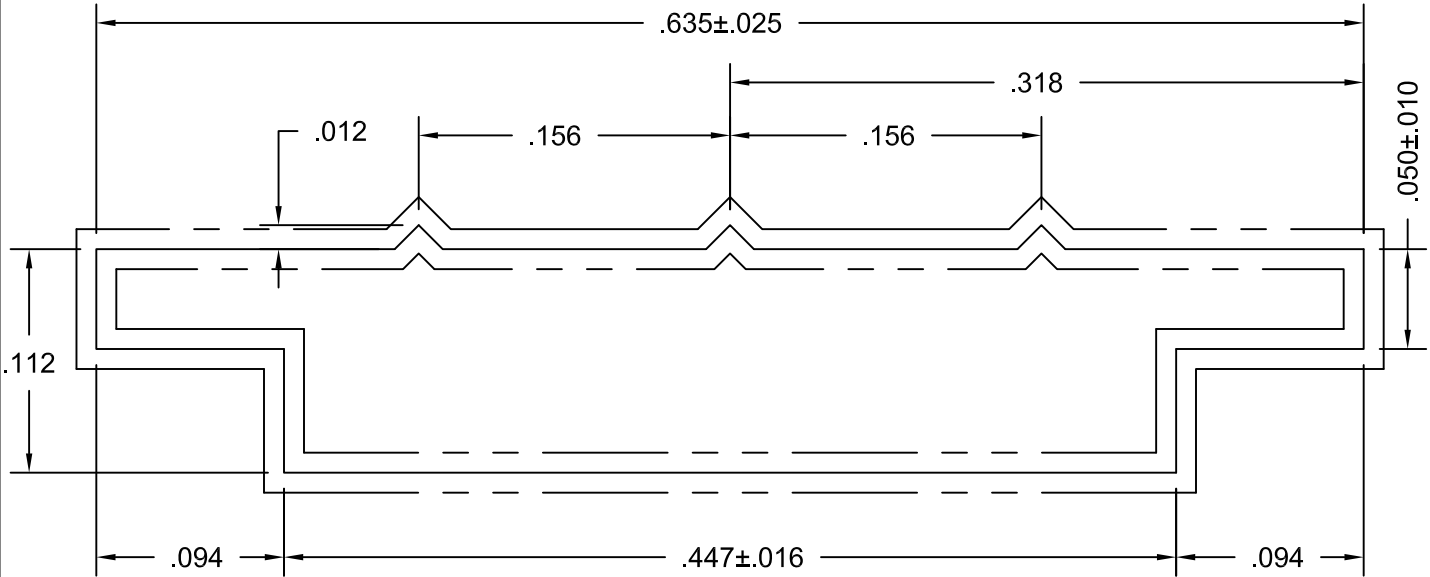

Ten Times Size

NOTE: Part to receive Silicone Bath after Extruding

Purchased Part
 Avon Rubber
 90 Durometer
 250' Rolls

© 2006 TUBELITE INC. ALL RIGHTS RESERVED

ALL UNSPECIFIED RADII .015

* INDICATES .031 RADIUS

DENOTES CRITICAL DIMENSION

TUBELITE®
 DEPENDABLE
 LEADERS IN ECO-EFFICIENT STOREFRONT,
 CURTAINWALL AND ENTRANCE SYSTEMS

3056 WALKER RIDGE NW, SUITE G
 WALKER, MICHIGAN 49544

REV	DATE	DESCRIPTION	INTL
A	01/19/96	Redrawn for AutoCAD	DMT

EPDM Rubber Glazing Use with M1061, M1063, M1202			
DRAWN BY	KMH	DRWG DATE	01/19/96
APPV,D BY		DATE APPV'D	
DRWG SCALE	Noted	PRODUCT CODE	380
P914			REV A

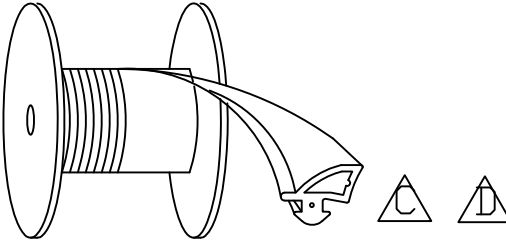

Material must UNREEL like this...

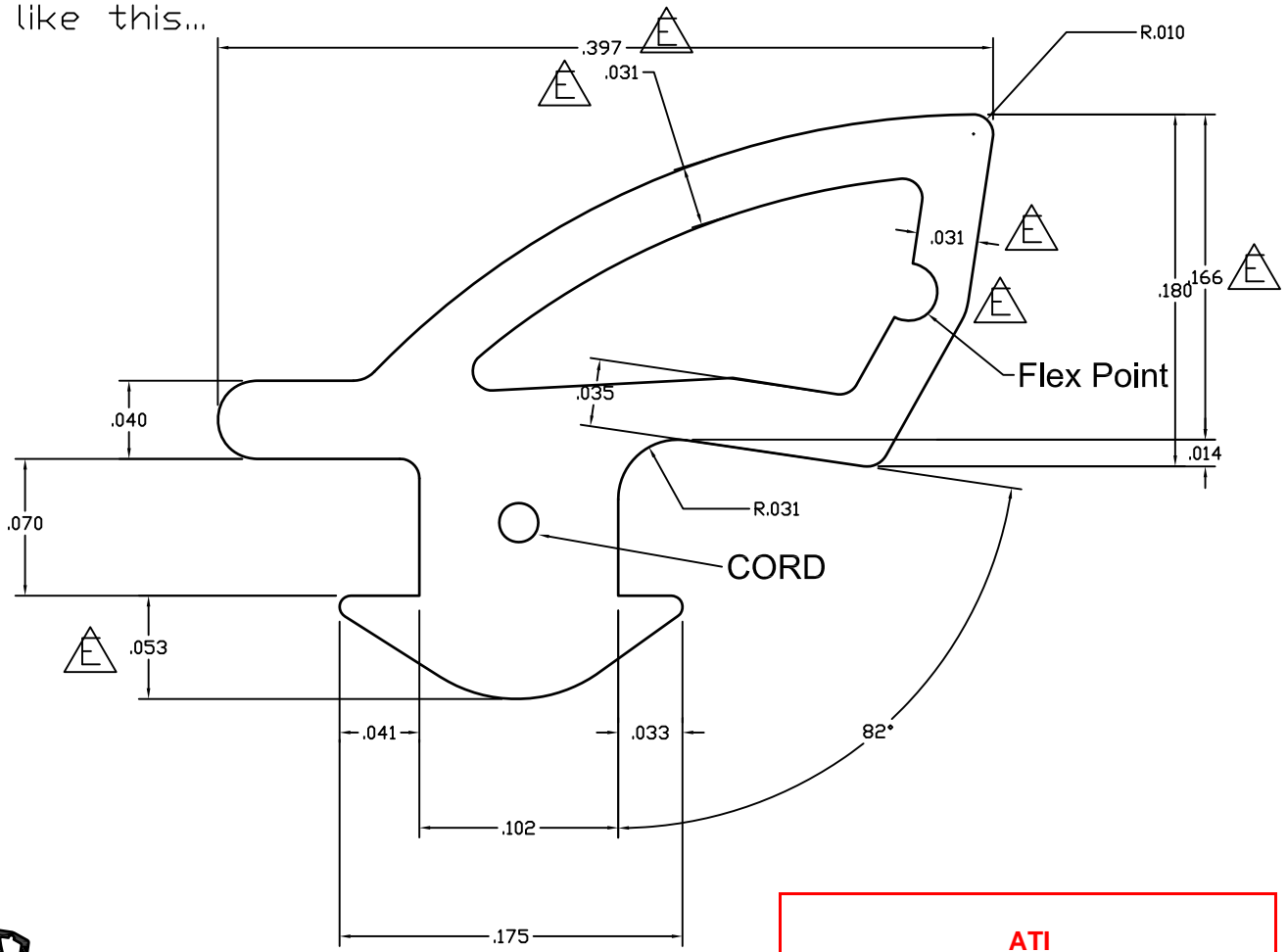

ACTUAL SIZE

ATI

Report # B3772-116-45

Date 10/20/2011

Simulator Eric Bahler

MATERIAL: EPDM 60 DUROMETER WITH CORD

© 2006 TUBELITE INC. ALL RIGHTS RESERVED
 ALL UNSPECIFIED RADII .015
 * INDICATES .031 RADIUS
 □ DENOTES CRITICAL DIMENSION



3056 WALKER RIDGE NW, SUITE G
 WALKER, MICHIGAN 49544

REV	DATE	DESCRIPTION	INTL
A	08/20/07	MODIFIED DART: .070 WAS .060 AND .051 WAS .061 ADDED CORD	NIK
B	10/16/08	ADDED MANUFACTURER'S TOLERANCES FOR REFERENCE	SRD
C	10/22/10	Modified gasket position of how the reel should roll	TT
D	12/16/10	Modified gasket position of how the reel should roll	TT
E	02/15/11	Rev flex pt, thickness was .032, .180 was .188	TT

1/4"-1" DOOR GLAZING GASKET 500' ROLLS			
DRAWN BY NIK	DRWG DATE 4-17-07	APPV.D BY	DATE APPV'D
DRWG SCALE 10X	PRODUCT CODE 100	P0017	REV E

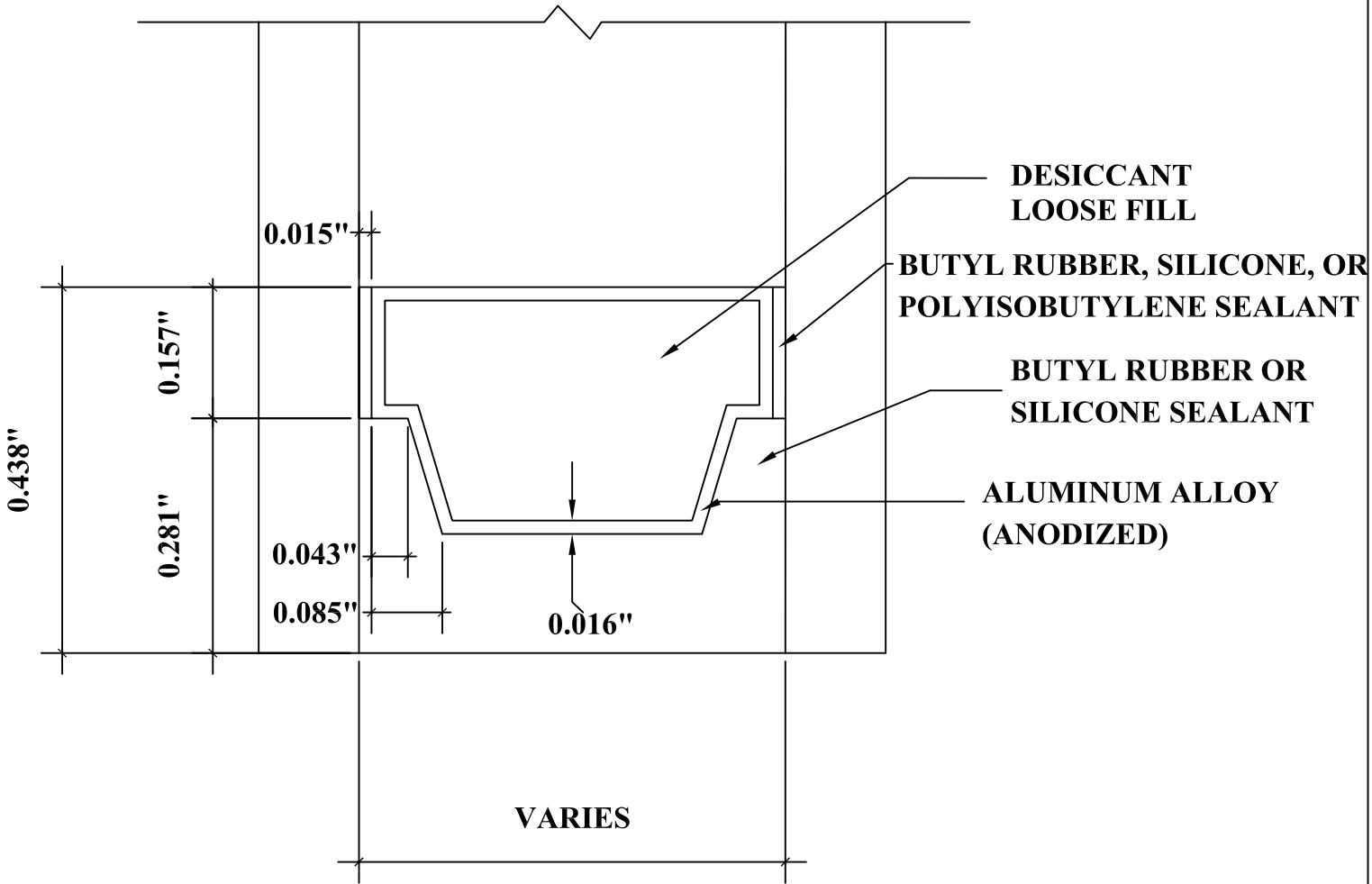

DETAIL FOR THERMAL MODELING OF
ALUMINUM SPACER (A1-D)