

AAMA 507-07 THERMAL PERFORMANCE REPORT

Rendered to:

TUBELITE, INC.

SERIES/MODEL: Standard 2" Wide Stile Single Door

TYPE: Swinging Door - Single

Report No: B3772.06-116-45
Report Date: 10/27/11

AAMA 507-07 THERMAL PERFORMANCE REPORT

Rendered to:

TUBELITE, INC.
4878 Mackinaw Trail
Reed City, Michigan 49677

Report No: B3772.06-116-45
Report Date: 10/27/11
Simulation Date: 10/27/11

Project Summary:

Architectural Testing, Inc. was contracted by Tubelite, Inc. to provide U-Factor and Solar Heat Gain Coefficient thermal performance ratings on the Standard 2" Wide Stile Single Door Swinging Door - Single. The thermal performance ratings were determined in accordance with AAMA 507-07, Standard Practice for Determining the Thermal Performance Characteristics of Fenestration Systems Installed in Commercial Building.

Reference Documents:

AAMA 507-07, Standard Practice for Determining the Thermal Performance Characteristics of Fenestration Systems Installed in Commercial Buildings

NFRC 100-2010, Procedure for Determining Fenestration Product U-Factors

NFRC 200-2010, Procedure for Determining Fenestration Product Solar Heat Gain Coefficient and Visible Transmittance at Normal Incidence

Simulation Specimen Description:

Series/Model: Standard 2" Wide Stile Single Door
Product Groupings: 2" Wide w/o sweep grouped with 2" Wide w/ sweep.
Type: Swinging Door - Single
Frame Material: Aluminum Framing System
Material Finish: Painted Aluminum
Specimen Size: 960mm wide by 2090mm high (37-3/4" by 82-3/8")
Configuration: Single vision Ilte
Drawing Reference: Tubelite Standard Doors - 2" Frame Details

Tubelite, Inc.
Standard 2" Wide Stile Single Door - Swinging Door - Single

System U-Factor vs. Percentage of Vision Area

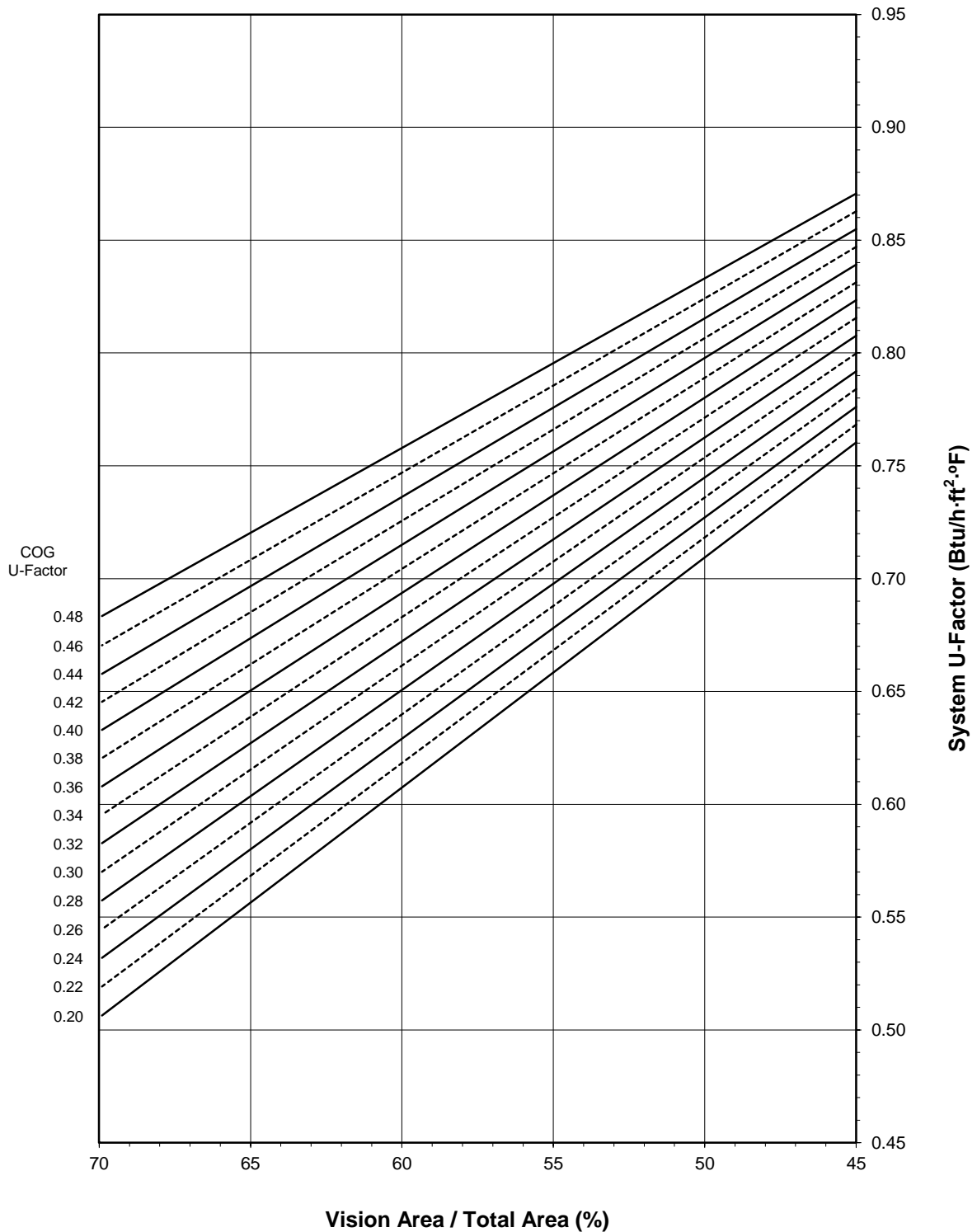

Note: 1 inch Overall - Dual Glazed Glass (0.48-0.20 COG) with Aluminum Spacer

Tubelite, Inc.
Standard 2" Wide Stile Single Door - Swinging Door - Single

System SHGC vs. Percentage of Vision Area

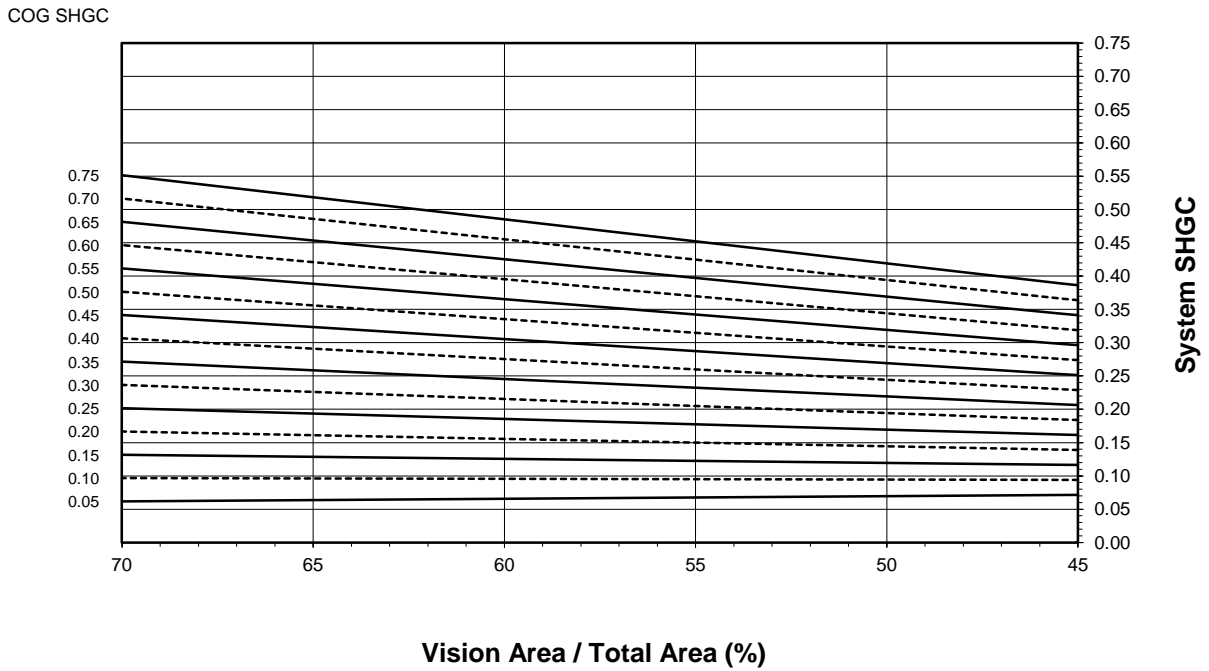

System VT vs. Percentage of Vision Area

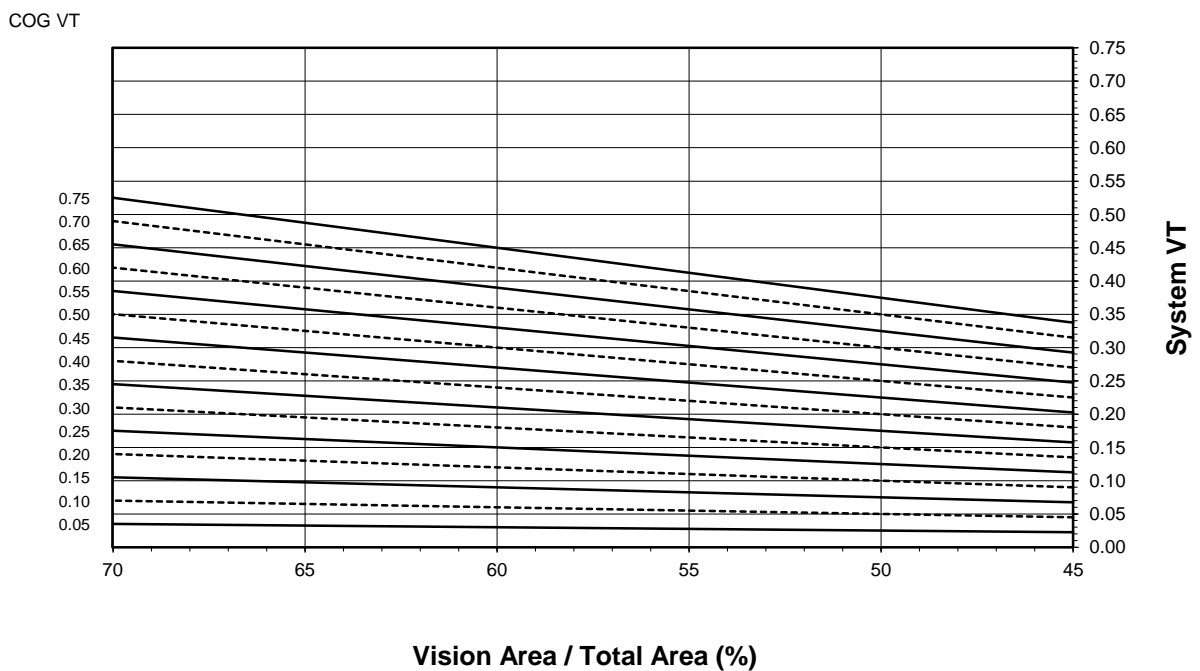

Tubelite, Inc.
Standard 2" Wide Stile Single Door - Swinging Door - Single

Size Specific U-Factor Matrix*

Glazing Option	Center of Glass U-Factor	Overall U-Factor
1	0.48	0.87
2	0.46	0.86
3	0.44	0.85
4	0.42	0.84
5	0.40	0.84
6	0.38	0.83
7	0.36	0.82
8	0.34	0.81
9	0.32	0.80
10	0.30	0.80
11	0.28	0.79
12	0.26	0.78
13	0.24	0.77
14	0.22	0.76
15	0.20	0.76

Note: 1 inch Overall - Dual Glazed Glass (0.48-0.20 COG) with Aluminum Spacer

Size Specific SHGC Matrix*

Center of Glass SHGC	Overall SHGC
0.75	0.39
0.70	0.37
0.65	0.34
0.60	0.32
0.55	0.30
0.50	0.28
0.45	0.25
0.40	0.23
0.35	0.21
0.30	0.18
0.25	0.16
0.20	0.14
0.15	0.12
0.10	0.09
0.05	0.07

Size Specific VT Matrix*

Center of Glass VT	Overall VT
0.75	0.34
0.70	0.32
0.65	0.30
0.60	0.27
0.55	0.25
0.50	0.23
0.45	0.20
0.40	0.18
0.35	0.16
0.30	0.14
0.25	0.11
0.20	0.09
0.15	0.07
0.10	0.05
0.05	0.02

*Size Specific U-Factor, SHGC, and VT Matrices are based on the standard Swinging Door - Single specimen size of 960mm wide by 2090mm high (37-3/4" by 82-3/8"). This represents 45.5% Vision Area / Total Area.

Vision Area Data

Option No.	COG U-Factor	COG Temperature	Cross Section	Frame Height	Frame U-Factor	Edge U-Factor	Total Product U-Factor		
							45% Vision Area	NFRC 100-2010	70% Vision Area
							37.42" by 81.48"	37.80" by 82.28"	74.05" by 159.44"
1	0.48	43.7	Head	8.2145	1.1967	0.5769	0.8706	0.8673	0.6834
			L. Jamb	8.1557	1.1768	0.5786			
			R. Jamb	8.1557	1.1768	0.5786			
			Sill	8.2770	1.1346	0.5812			
2	0.46	44.8	Head	8.2145	1.1967	0.5633	0.8628	0.8593	0.6704
			L. Jamb	8.1557	1.1768	0.5650			
			R. Jamb	8.1557	1.1768	0.5650			
			Sill	8.2770	1.1344	0.5675			
3	0.44	45.8	Head	8.2145	1.1966	0.5497	0.8549	0.8514	0.6578
			L. Jamb	8.1557	1.1767	0.5515			
			R. Jamb	8.1557	1.1767	0.5515			
			Sill	8.2770	1.1343	0.5539			
4	0.42	46.8	Head	8.2145	1.1965	0.5363	0.8470	0.8434	0.6454
			L. Jamb	8.1557	1.1767	0.5381			
			R. Jamb	8.1557	1.1767	0.5381			
			Sill	8.2770	1.1342	0.5404			
5	0.40	47.9	Head	8.2145	1.1965	0.5229	0.8392	0.8355	0.6330
			L. Jamb	8.1557	1.1766	0.5248			
			R. Jamb	8.1557	1.1766	0.5248			
			Sill	8.2770	1.1341	0.5270			
6	0.38	48.9	Head	8.2145	1.1965	0.5098	0.8313	0.8275	0.6205
			L. Jamb	8.1557	1.1766	0.5116			
			R. Jamb	8.1557	1.1766	0.5116			
			Sill	8.2770	1.1340	0.5136			
7	0.36	50.0	Head	8.2145	1.1964	0.4965	0.8234	0.8196	0.6079
			L. Jamb	8.1557	1.1765	0.4984			
			R. Jamb	8.1557	1.1765	0.4984			
			Sill	8.2770	1.1338	0.5002			
8	0.34	51.0	Head	8.2145	1.1963	0.4834	0.8156	0.8116	0.5954
			L. Jamb	8.1557	1.1765	0.4853			
			R. Jamb	8.1557	1.1765	0.4853			
			Sill	8.2770	1.1337	0.4872			
9	0.32	52.0	Head	8.2145	1.1963	0.4703	0.8077	0.8036	0.5828
			L. Jamb	8.1557	1.1765	0.4721			
			R. Jamb	8.1557	1.1765	0.4721			
			Sill	8.2770	1.1336	0.4740			
10	0.30	53.1	Head	8.2145	1.1963	0.4573	0.7998	0.7957	0.5701
			L. Jamb	8.1557	1.1764	0.4592			
			R. Jamb	8.1557	1.1764	0.4592			
			Sill	8.2770	1.1335	0.4610			

Vision Area Data

Option No.	COG U-Factor	COG Temperature	Cross Section	Frame Height	Frame U-Factor	Edge U-Factor	Total Product U-Factor		
							45% Vision Area	NFRC 100-2010	70% Vision Area
							37.42" by 81.48"	37.80" by 82.28"	74.05" by 159.44"
11	0.28	54.2	Head	8.2145	1.1962	0.4443	0.7919	0.7877	0.5574
			L. Jamb	8.1557	1.1764	0.4462			
			R. Jamb	8.1557	1.1764	0.4462			
			Sill	8.2770	1.1334	0.4479			
12	0.26	55.2	Head	8.2145	1.1962	0.4314	0.7840	0.7797	0.5446
			L. Jamb	8.1557	1.1764	0.4333			
			R. Jamb	8.1557	1.1764	0.4333			
			Sill	8.2770	1.1333	0.4349			
13	0.24	56.3	Head	8.2145	1.1962	0.4185	0.7761	0.7717	0.5319
			L. Jamb	8.1557	1.1763	0.4205			
			R. Jamb	8.1557	1.1763	0.4205			
			Sill	8.2770	1.1332	0.4220			
14	0.22	57.3	Head	8.2145	1.1962	0.4058	0.7683	0.7638	0.5193
			L. Jamb	8.1557	1.1763	0.4077			
			R. Jamb	8.1557	1.1763	0.4077			
			Sill	8.2770	1.1331	0.4092			
15	0.20	58.4	Head	8.2145	1.1962	0.3930	0.7604	0.7558	0.5064
			L. Jamb	8.1557	1.1763	0.3949			
			R. Jamb	8.1557	1.1763	0.3949			
			Sill	8.2770	1.1331	0.3963			

Detailed drawings, datasheets, representative samples of test specimens, a copy of this report, or other pertinent project documentation will be retained by Architectural Testing, Inc. for a period of four years from the original test date. At the end of this retention period such materials shall be discarded without notice and the service life of this report by Architectural Testing will expire. Results obtained are simulated values and were secured by using the designated test methods. This report does not constitute certification of this product nor an opinion or endorsement by this laboratory. It is the exclusive property of the client named herein and relates only to the specimen(s) simulated. This report may not be reproduced, except in full, without the written approval of Architectural Testing, Inc.

For ARCHITECTURAL TESTING, INC.:

SIMULATED BY:

REVIEWED BY:

Eric Barilar
Simulation Technician

Kevin S. Louder
Project Engineer

EAB:EAB
B3772.06-116-45

Attachments (pages): This report is complete only when all attachments listed are included.

Appendix A: Drawings and Bills of Material (18)

Revision Log

<u>Rev. #</u>	<u>Date</u>	<u>Page(s)</u>	<u>Revision(s)</u>
.01R0	10/27/2011	All	Original Report Issue

All drawings and Bills of Material used in simulating this product are enclosed in this Appendix.

ATI

Report # B3772-116-45Date 10/20/2011Simulator Eric Bakula**STANDARD SINGLE DOOR BOM -2.0" Frame****FRAME:**

Description	QTY	Part number	Material
Jamb 2" x 4 1/2"	2	E14144	
Header 2" x 4 1/2"	1	E14124	
Door stops	3	E4531	
Weather pile	30 ft	P1098A	vinyl
closure open back plate	2	E4543	

DOOR:

Description	QTY	Narrow P/N	Medium P/N	Wide P/N	Material
Beveled Door Stiles	2	E0055 - 2 1/8"	E0086- 4"	E0416 - 5"	
Door Top Rail	1	E0255- 2 1/8"	E0054- 4"	E0318 - 5"	
Top Rail Lug	2	P168	P031	P339	AL
Door Botom Rail	1	E0054- 4"	E0419- 6 1/2"	E0419- 6 1/2"	
Bottom Rail Lug	2	P031	P341	P341	AL
Top Rail & Bottom Rail Tie Rods	2	P020	P020	P020	Steel
Washer for Tie Rods	4	P853	P853	P853	AL
Hex nuts for Tie rods	4	S071A	S071A	S071A	Steel
Exterior Glass Stop 1" glass	4	E0927	E0927	E0927	
Interior Glass Stop 1" glass	4	E0928	E0928	E0928	
Gasket	36 ft	P0017	P0017	P0017	EPDM
Adjustable Wedge Setting Blck	2	P1911	P1911	P1911	Polypropylene
Self Adhesive Setting Blck	3	P1912	P1912	P1912	EPDM
Threshold	1	E0019	E0019	E0019	
Threshold clip	2	P679	P679	P679	AL

MATERIAL:

E - All E part numbers are AL extrusions

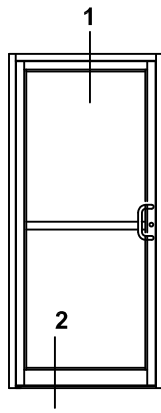

Standard Doors - Single 2" Frame Elevations & 1/4 Size Details

ATI	
Report #	<u>B3772-116-45</u>
Date	<u>10/20/2011</u>
Simulator	<u><i>Eric Borillo</i></u>

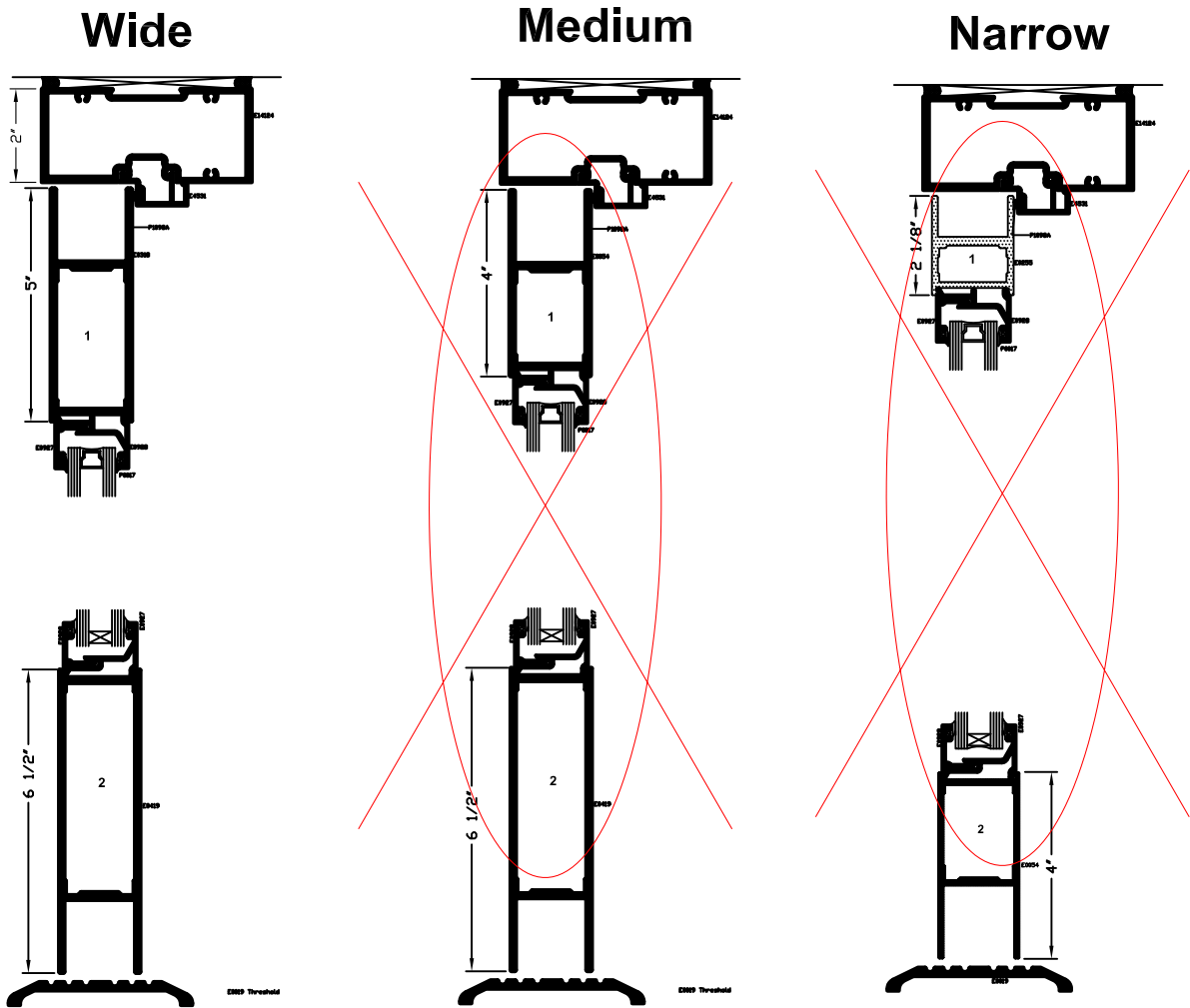

*SEALANT, ROD, & ANCHORS NOT BY TUBELITE

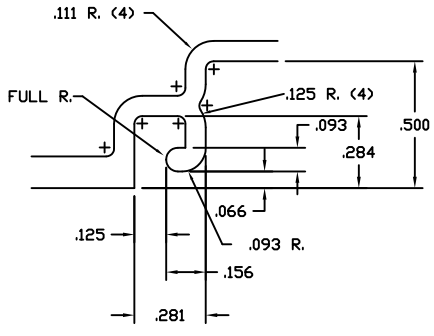

TWO TIMES SIZE

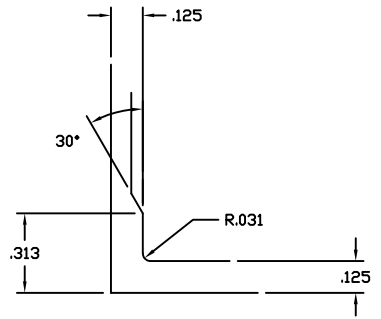

TWO TIMES SIZE

ATI

Report # B3772-116-45

Date 10/20/2011

Simulator Eric Bostick

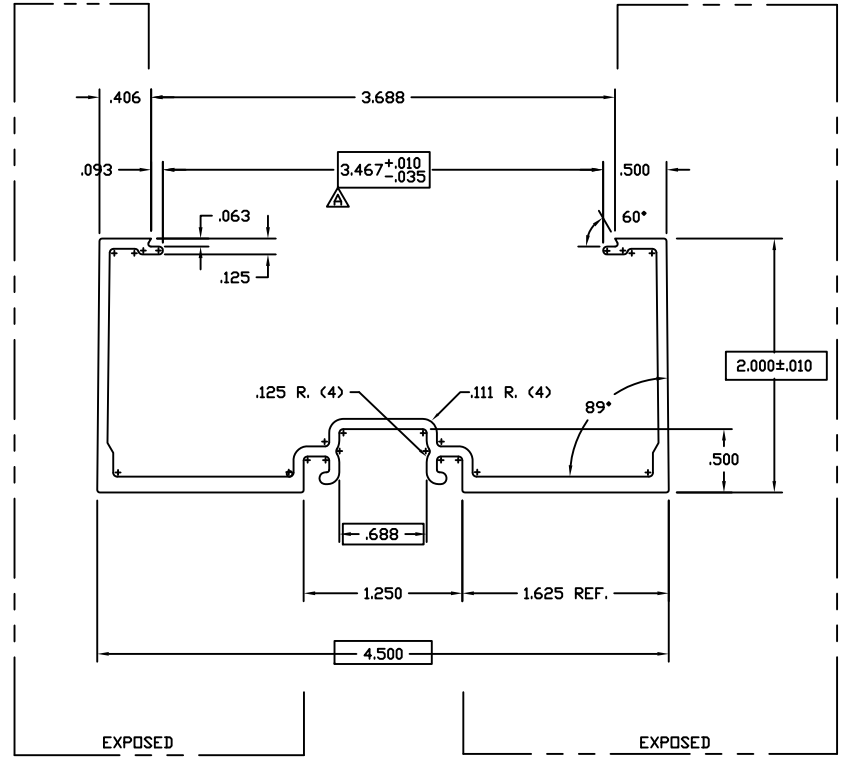

ACTUAL SIZE

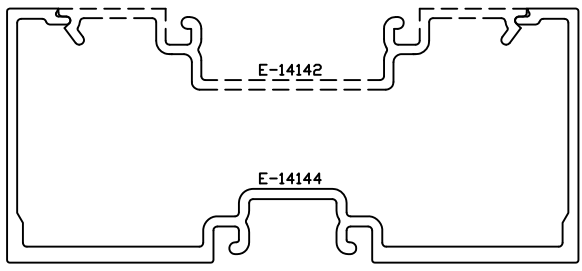

ASSEMBLY

ALSO MATES WITH E-4543 FLAT CLOSURE

©2006 TUBELITE INC. ALL RIGHTS RESERVED
 ALUMINUM ASSOCIATION STANDARD TOLERANCES APPLY UNLESS NOTED

TUBELITE
 DEPENDABLE
 LEADING IN ECO-FRIENDLY OPERATIONAL CURTAINWALL AND ENTRANCE SYSTEMS

3056 WALKER RIDGE NW, SUITE G
 WALKER, MICHIGAN 49544

WALL THK	.080	SECTION CLASS	S	MAT'L	6063-T5	RATIO	59:1
PERIMETER OUT (TOTAL)	21.100	AREA	1.001	WGT/FT	1.178		
FACTOR	19	CIRCLE SIZE	4.924	INTELL VOLUME	N/A		
RXX	1.672	SXX	1.245	IXX	2.801	CXX	2.250
RYY	.643	SYY	.287	IYY	.414	CYY	1.444

DENOTES CRITICAL DIMENSION
 ALL DIES PROPERTY OF TUBELITE

REV	DATE	DESCRIPTION	INTL
	5-13-93	RELEASE TO TOOLING	RHH
	7-7-93	REVISE EXTR # VAS E-14006	RHH
	7-29-93	RELEASE TO PRODUCTION	RHH
	10-28-96	REVISE EXTR # E-14144 TO BE SYMMETRICAL	SRK
	12-12-96	RE-RELEASE TO PRODUCTION	SRK
A	03/28/07	REDUCED OPENING FOR BETTER FIT	NIK

DOOR JAMB 2" X 4 1/2"
E14000 NON THERMAL STOREFRONT

DRAWN BY	KMH	DRWG DATE	05/13/93	APPV'D BY		DATE APPV'D	
DWG SCALE	NOTED	PRODUCT CODE	190		E14144		

E14124
A

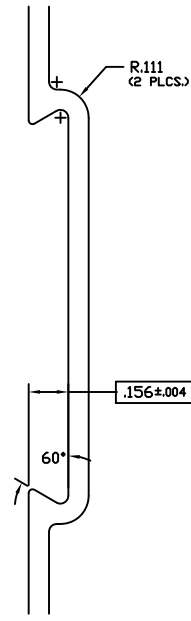

TWO TIMES SIZE

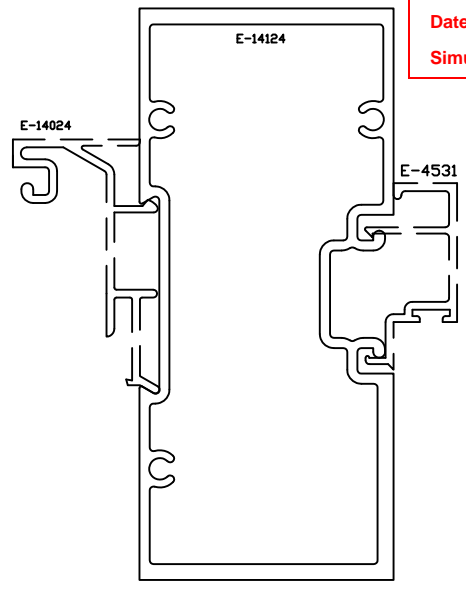

ASSEMBLY

MATES W/ E-4532, E-4026 & E-14024

ATI
 Report # B3772-116-45
 Date 10/20/2011
 Simulator Eric Basille

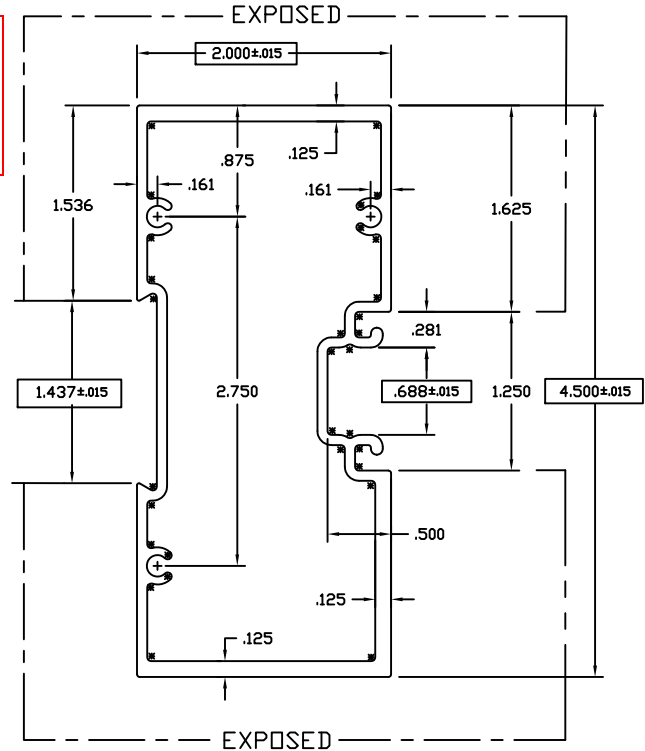

ACTUAL SIZE

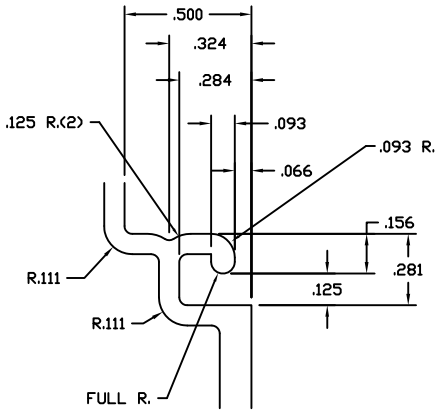

TWO TIMES SIZE

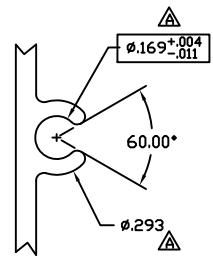

TWO TIMES SIZE

©2006 TUBELITE INC. ALL RIGHTS RESERVED
 ALUMINUM ASSOCIATION STANDARD
 TOLERANCES APPLY UNLESS NOTED
 ALL UNSPECIFIED RADII .015
 * INDICATES .031 RADIUS
 DENOTES CRITICAL DIMENSION
 ALL DIES PROPERTY OF TUBELITE

TUBELITE
 LEADING IN ECO-FRIENDLY OPERATING
 CURTAINWALL AND ENTRANCE SYSTEMS

3056 WALKER RIDGE NW, SUITE G
 WALKER, MICHIGAN 49544

WALL THK	.080	SECTION H		MAT'L	6063-T5	RATIO	38:1
PERIMETER OUT (TOTAL)	15.371(29.969)		AREA	1.464	WGT/FT	1.722	
FACTOR	17	CIRCLE SIZE	4.924	INFILL VOLUME	N/A		
RXX	1.601	SXX	1.640	IXX	3.751	CXX	2.287
RYY	.780	SYY	.849	IYY	.890	CYY	1.049

DOOR HEADER 2" X 4 1/2"
 E14000 NON THERMAL STOREFRONT

DRAWN BY	SMH	DRWG DATE	05/11/93	APPV'D BY		DATE APPV'D	
DWG SCALE	NOTED	PRODUCT CODE	190	E14124			

REV	DATE	DESCRIPTION	INTL
	9-11-93	RELEASE TO TOOLING	KMH
	7-7-93	REVISE EXTR. # WAS E-14023	KMH
	7-28-93	RELEASE TO PRODUCTION	KMH
A	1/17/2011	J69 +.004/-0.011 was .162+/-0.004, .293 WAS .322	CRH

E4531

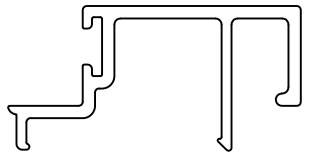
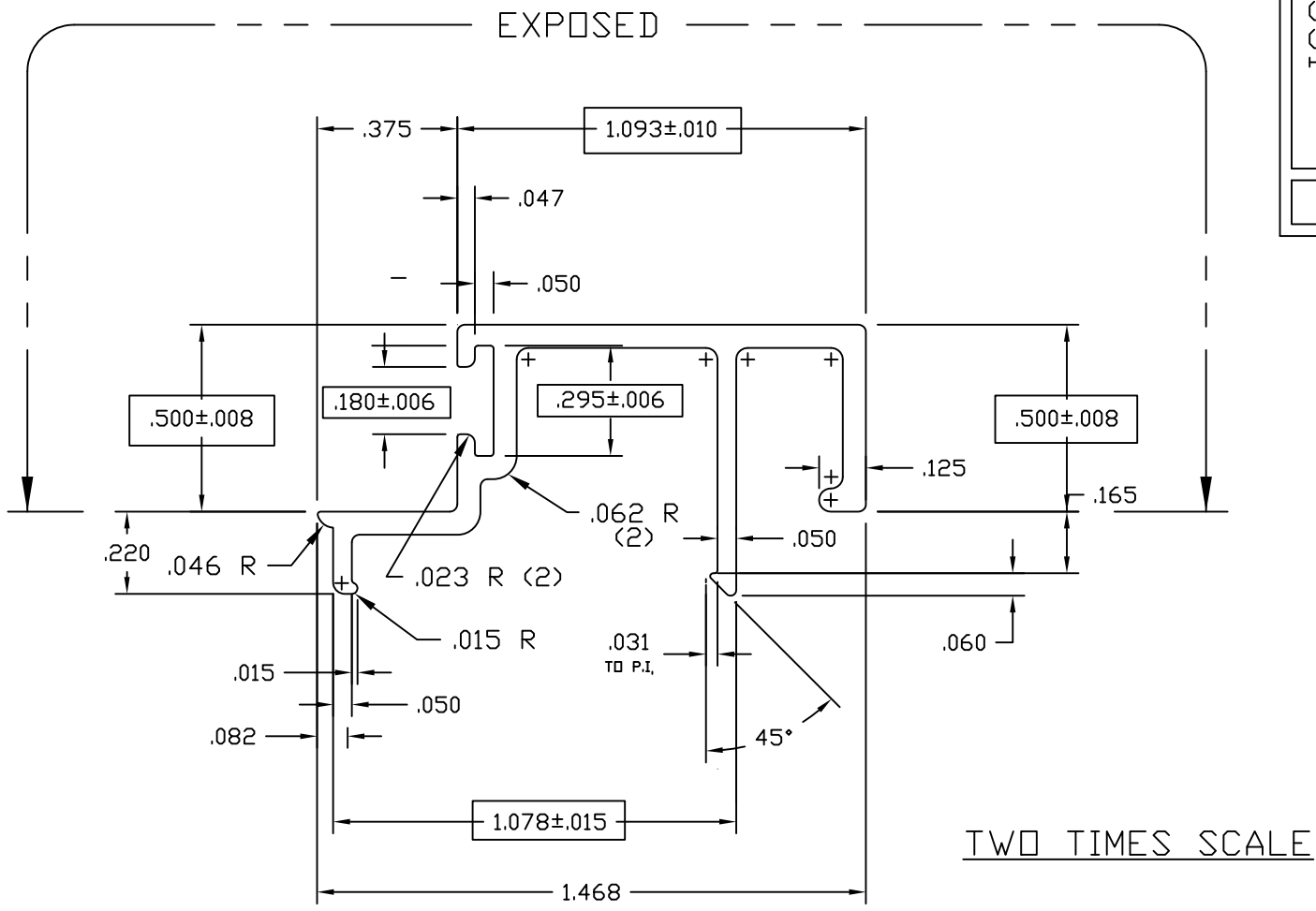

ACTUAL SIZE

ATI

Report # B3772-116-45

Date 10/20/2011

Simulator Eric Barlow

USED WITH 4500 SERIES
REPLACES E-4510
USE WITH P-1098A WEATHERING

© 2006 TUBELITE INC. ALL RIGHTS RESERVED
ALUMINUM ASSOCIATION STANDARD
TOLERANCES APPLY UNLESS NOTED
ALL UNSPECIFIED RADII .015
* INDICATES .031 RADIUS



3056 WALKER RIDGE NW, SUITE G
WALKER, MICHIGAN 49544

WALL THK.	.062	SECTION CLASS	S	MAT'L	6063-T5	RATIO	90
PERIMETER OUT (TOTAL)	6.966	AREA	.203	WGT/FT	.238		
FACTOR	29	CIRCLE SIZE	1.58	INFILL VOLUME	N/A		

RXX	.446	SXX	.049	IXX	.040	CXX	.824
RYY	.218	SYY	.021	IYY	.010	CYY	.461

DOOR STOP 1/2" X 1 3/32"
E4500 STOREFRONT

☐ DENOTES CRITICAL DIMENSION
ALL DIES PROPERTY OF TUBELITE

REV	DATE	DESCRIPTION	INTL
	3/28/94	UPDATED SECTION PROPERTIES	TPB
	4/12/99	UPDATED EXPOSED	JEK

DRAWN BY	LS	DRWG DATE	02/07/85	APPV'D BY		DATE APPV'D	
DWG SCALE	NOTED	PRODUCT CODE	160	E4531		REV	

ATI
Report # B3772-116-45
Date 10/20/2011
Simulator Eric Bakula

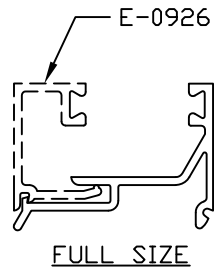
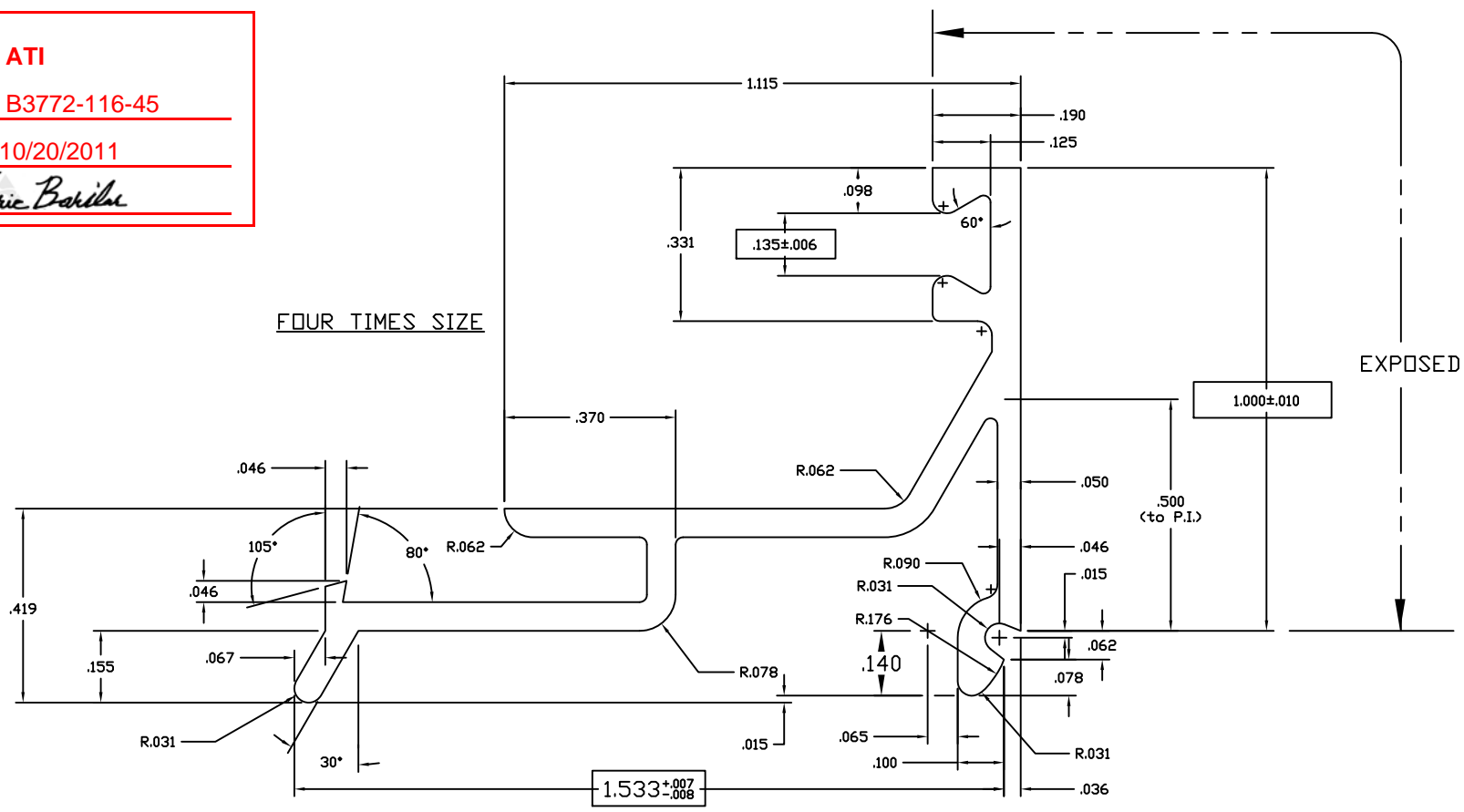

NOTES:

- 1) USE E-0927/0928 FOR 1" MAT'L
- 2) USE E-0926/0928 FOR 5/8" MAT'L
- 3) USE GLAZING BEAD P-302 FOR BOTH SIDES OF GLASS OR PANEL

©2006 TUBELITE INC. ALL RIGHTS RESERVED
 ALUMINUM ASSOCIATION STANDARD TOLERANCES APPLY UNLESS NOTED
 ALL UNSPECIFIED RADII .015
 * INDICATES .031 RADIUS
 DENOTES CRITICAL DIMENSION
 ALL DIES PROPERTY OF TUBELITE

TUBELITE
 LEADING IN ECO-FRIENDLY OPERATING CURTAINWALL AND ENTRANCE SYSTEMS
 3056 WALKER RIDGE NW, SUITE G
 WALKER, MICHIGAN 49544

WALL THK	.062	SECTION CLASS	S	MAT'L	6063-T5	RATIO	59:1
PERIMETER OUT (TOTAL)	7.540	AREA	.234	WGT/FT	.275		
FACTOR	27	CIRCLE SIZE	1.938	INFILL VOLUME	N/A		
RXX	.302	SXX	.030	IXX	.021	CXX	.701
RYY	.501	SYX	.113	IYY	.059	CYY	1.049

GLASS STOP, 1" HIGH FOR 1" GLASS STOCK DOORS

DRAWN BY	DWG DATE	07/03/84	APPV'D BY	DATE APPV'D
DWG SCALE	NOTED	PRODUCT CODE	100	E0928

REV	DATE	DESCRIPTION	INTL
	10/12/07	REMOVED LEG	RW

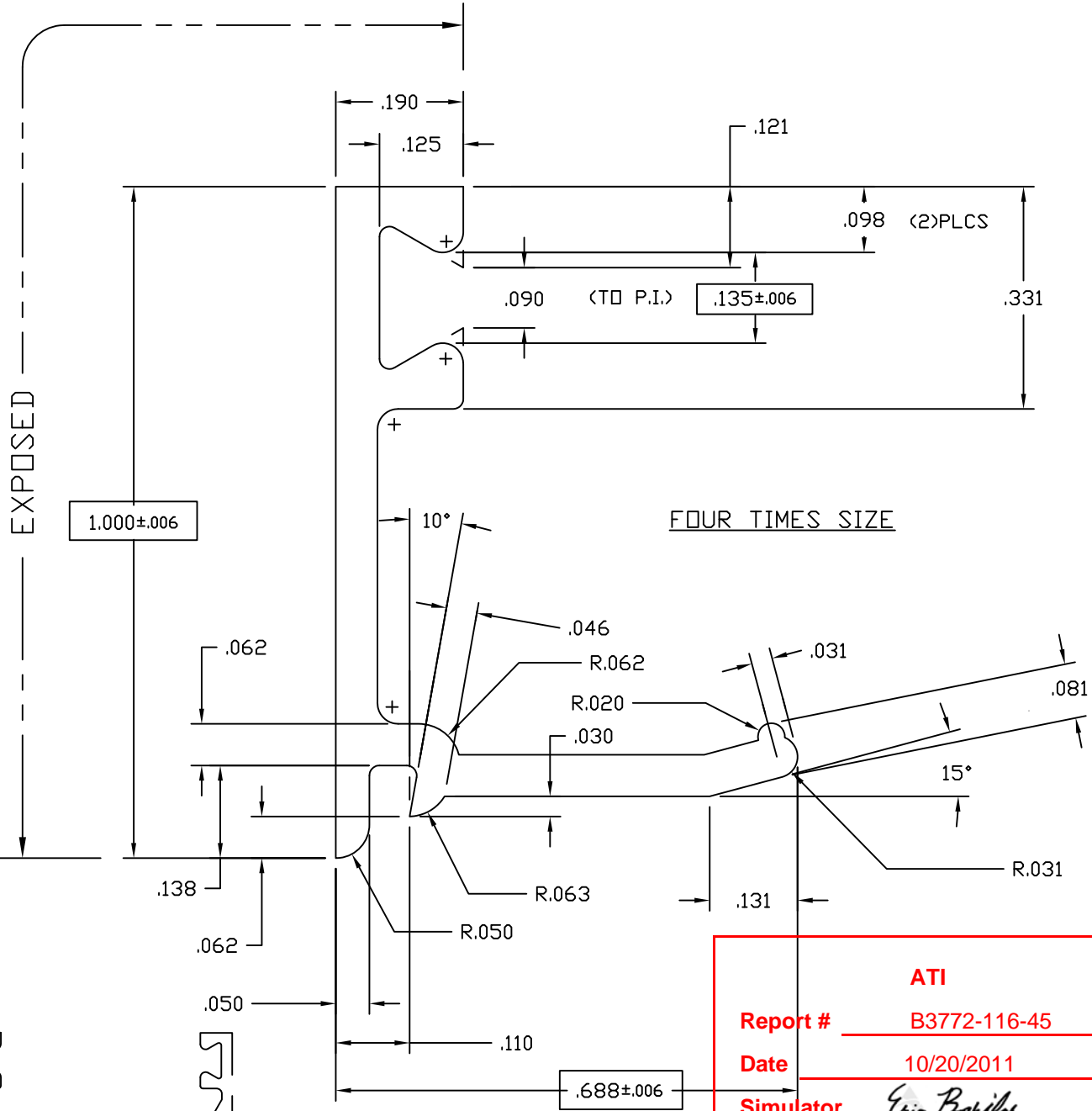

ATI

Report # B3772-116-45

Date 10/20/2011

Simulator Eric Borish

- NOTES:
- 1) USE WITH 1" INSULATED GLASS OR 1" PANEL
 - 2) USE GLAZING BEAD P-302 BOTH SIDES
 - 3) USE WITH E-0928 OR E-0929

© 2006 TUBELITE INC. ALL RIGHTS RESERVED
 ALUMINUM ASSOCIATION STANDARD TOLERANCES APPLY UNLESS NOTED
 ALL UNSPECIFIED RADII .015
 * INDICATES .031 RADIUS

TUBELITE
 LEADERS IN ECO-EFFICIENT STOREFRONT, CURTAINWALL AND ENTRANCE SYSTEMS

3056 WALKER RIDGE NW, SUITE G
 WALKER, MICHIGAN 49544

WALL THK.	.062	SECTION CLASS	S	MAT'L	6063-T5	RATIO	74:1
PERIMETER OUT (TOTAL)	4.001	AREA	.124	WGT/FT	.146	INFILL VOLUME	N/A
FACTOR	27	CIRCLE SIZE	1.120				

RXX	.321	SXX	.023	IXX	.013	CXX	.321
RYY	.185	SYY	.008	IYY	.004	CYY	.185

GLASS STOP, 1" HIGH FOR 1" GLASS STOCK DOORS

DRAWN BY	CRH	DRWG DATE	04/21/99	APPV'D BY		DATE APPV'D	
DWG SCALE	NOTED	PRODUCT CODE	100	E0927		REV	

REV	DATE	DESCRIPTION	INTL
X	xx/xx/xx	xxxxxxxxxxxxxx	xxx

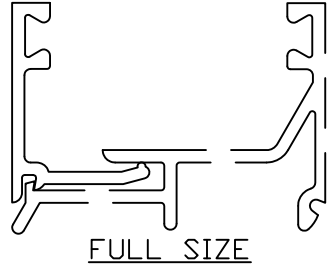

E0419
B

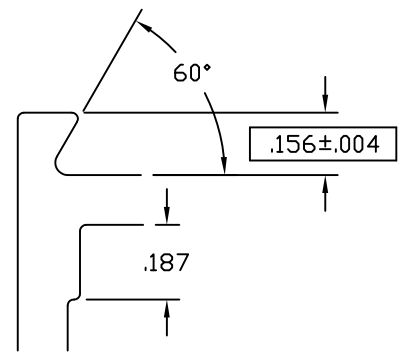
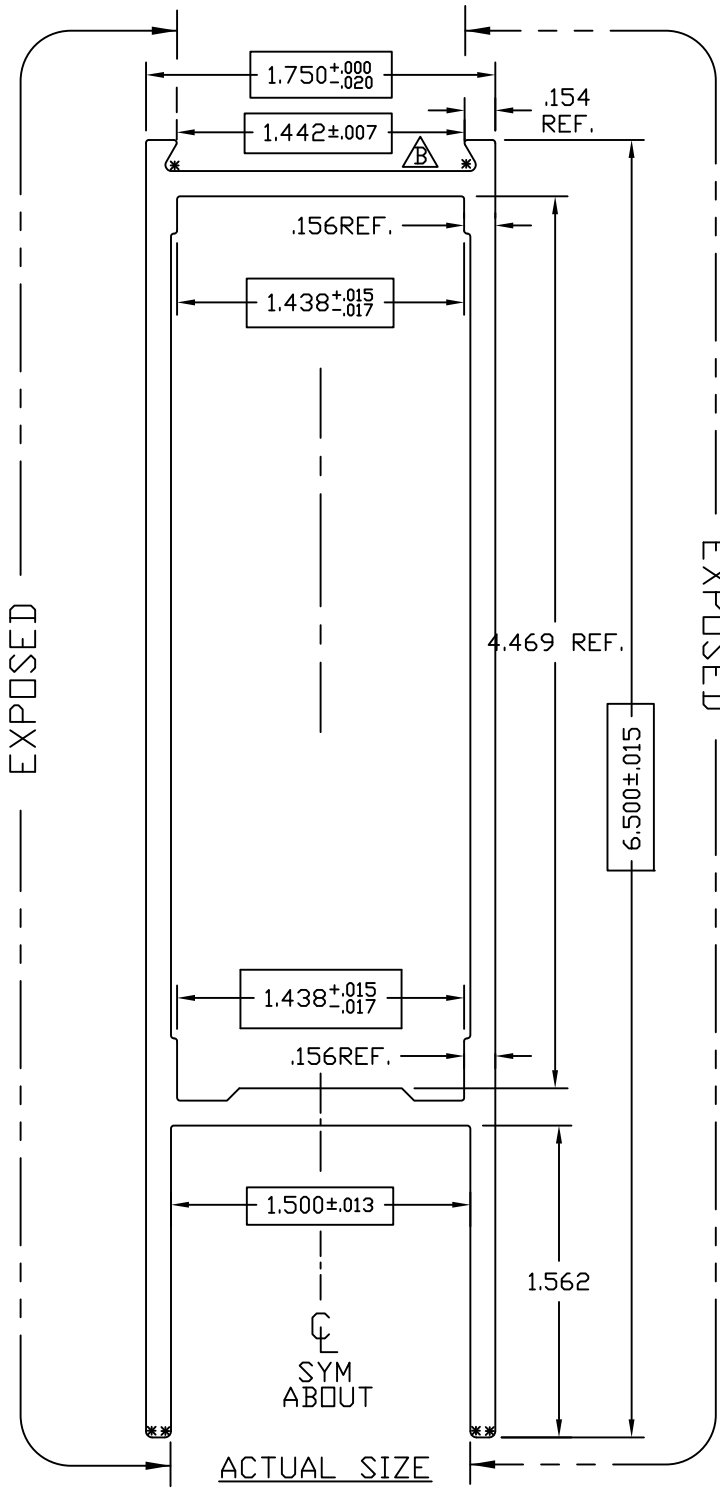

TWO TIMES SCALE

ATI

Report # B3772-116-45

Date 10/20/2011

Simulator Eric Barthe

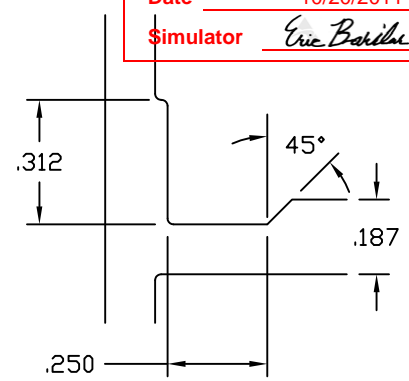

TWO TIMES SCALE

$.125^{+.003}_{-.011}$ TYP WALL UNLESS NOTED

SNAP FIT W/E-0437

© 2006 TUBELITE INC. ALL RIGHTS RESERVED
ALUMINUM ASSOCIATION STANDARD TOLERANCES APPLY UNLESS NOTED
ALL UNSPECIFIED RADII .015
* INDICATES .031 RADIUS

TUBELITE
DEPENDABLE
LEADERS IN ECO-EFFICIENT STOREFRONT, CURTAINWALL AND ENTRANCE SYSTEMS

3056 WALKER RIDGE NW, SUITE G
WALKER, MICHIGAN 49544

WALL THK.	NOTED	SECTION CLASS	H	MAT'L	6063-T5	RATIO	26:1
PERIMETER OUT (TOTAL)	19.959(26.440)	AREA	2.084	WGT/FT	2.451		
FACTOR	11	CIRCLE SIZE	6.720	INFILL VOLUME	N/A		

RXX	.747	SXX	1.330	IXX	1.164	CXX	.875
RYY	1.980	SYX	2.447	IYY	8.175	CYY	3.340

HORIZONTAL RAIL 6 1/2" X 1 3/4"
CUSTOM DOORS/FRAMES

DRAWN BY	DH	DRWG DATE	04/19/84	APPV'D BY	CRH	DATE APPV'D	12/08/00
----------	----	-----------	----------	-----------	-----	-------------	----------

DWG SCALE	NOTED	PRODUCT CODE	110	E0419	REV	B
-----------	-------	--------------	-----	-------	-----	---

REV	DATE	DESCRIPTION	INTL
A	11/16/00	1.449 WAS 1.438	CRH
B	07/08/03	1.449 +/--.007 WAS 1.449 +.000/-.010	CRH

E0416
D

ATI
 Report # B3772-116-45
 Date 10/20/2011
 Simulator Eric Barthe

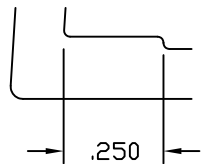

TWO TIMES SIZE

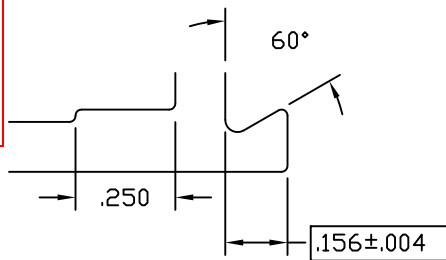

TWO TIMES SIZE

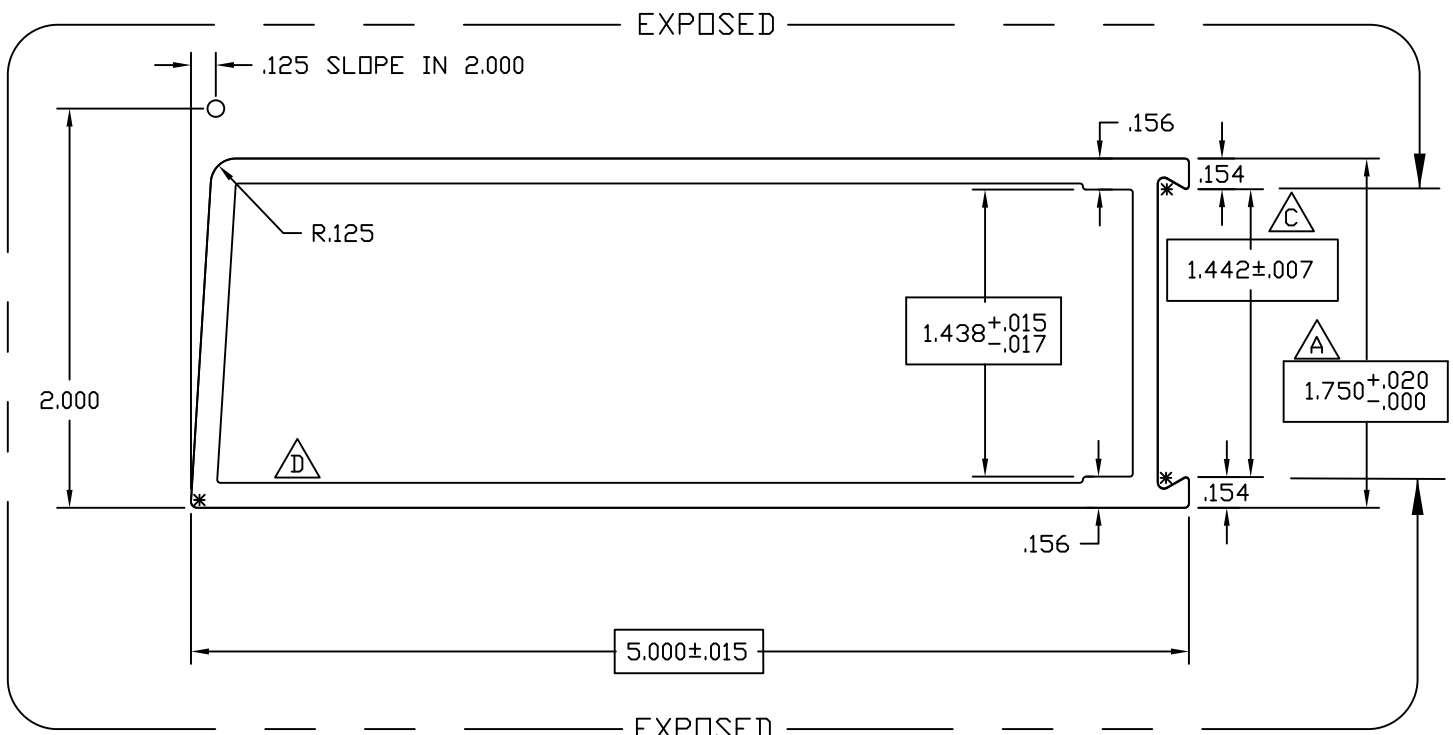

EXPOSED
 EXPOSED
 ACTUAL SIZE

$.125^{+.003}_{-.011}$ TYP WALL UNLESS NOTED

SNAP FIT W/E-0437

© 2006 TUBELITE INC. ALL RIGHTS RESERVED
 ALUMINUM ASSOCIATION STANDARD
 TOLERANCES APPLY UNLESS NOTED
 ALL UNSPECIFIED RADII .015
 * INDICATES .031 RADIUS

TUBELITE
 DEPENDABLE
 LEADERS IN ECO-EFFICIENT STOREFRONT,
 CURTAINWALL AND ENTRANCE SYSTEMS

3056 WALKER RIDGE NW, SUITE G
 WALKER, MICHIGAN 49544

WALL THK.	NOTED	SECTION CLASS	H	MAT'L	6063-T5	RATIO	34:1
PERIMETER OUT (TOTAL)	13.733	AREA	1.623	WGT/FT	1.909		
FACTOR	13	CIRCLE SIZE	5.293	INFILL VOLUME	N/A		

RXX	.742	SXX	1.012	IXX	.893	CXX	.883
RYY	1.686	SYX	1.823	IYY	4.611	CYY	2.529

BEVELED VERTICAL RAIL 1 3/4" X 5"
 CUSTOM DOORS/FRAMES

DRAWN BY	DH	DRWG DATE	04/08/84	APPV'D BY		DATE APPV'D	
DWG SCALE	NOTED	PRODUCT CODE	110	E0416		REV	D

REV	DATE	DESCRIPTION	INTL
A	1/21/92	+0.020/-0.000 WAS +/-0.010	KMH
B	04/10/01	1.449 +0.000/-0.010 WAS 1.438 +0.002/-0.013	CRH
C	10/15/02	1.442+/-0.007 WAS 1.449 +0.000/-0.010	CRH
D	12/08/10	RMV .030 step in innser lower left corner	TT

□ DENOTES CRITICAL DIMENSION
 ALL DIES PROPERTY OF TUBELITE

ATI
 Report # B3772-116-45
 Date 10/20/2011
 Simulator Eric Barthe

E0318
 B

EXPOSED

EXPOSED

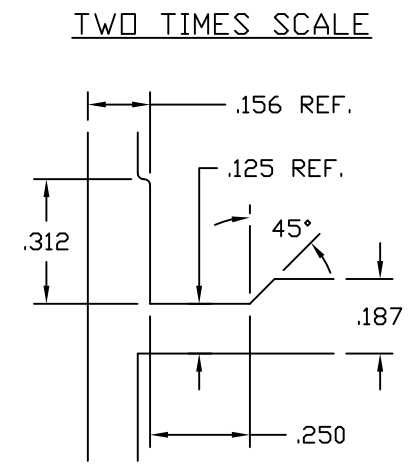
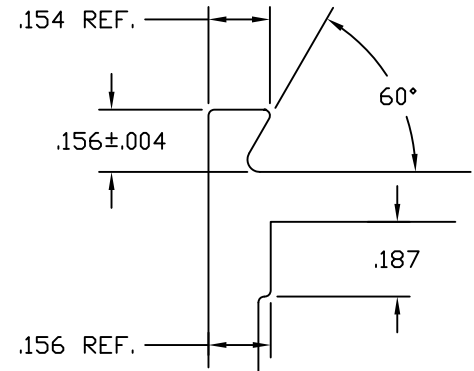
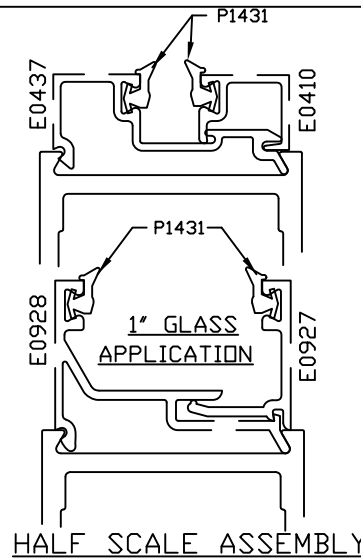
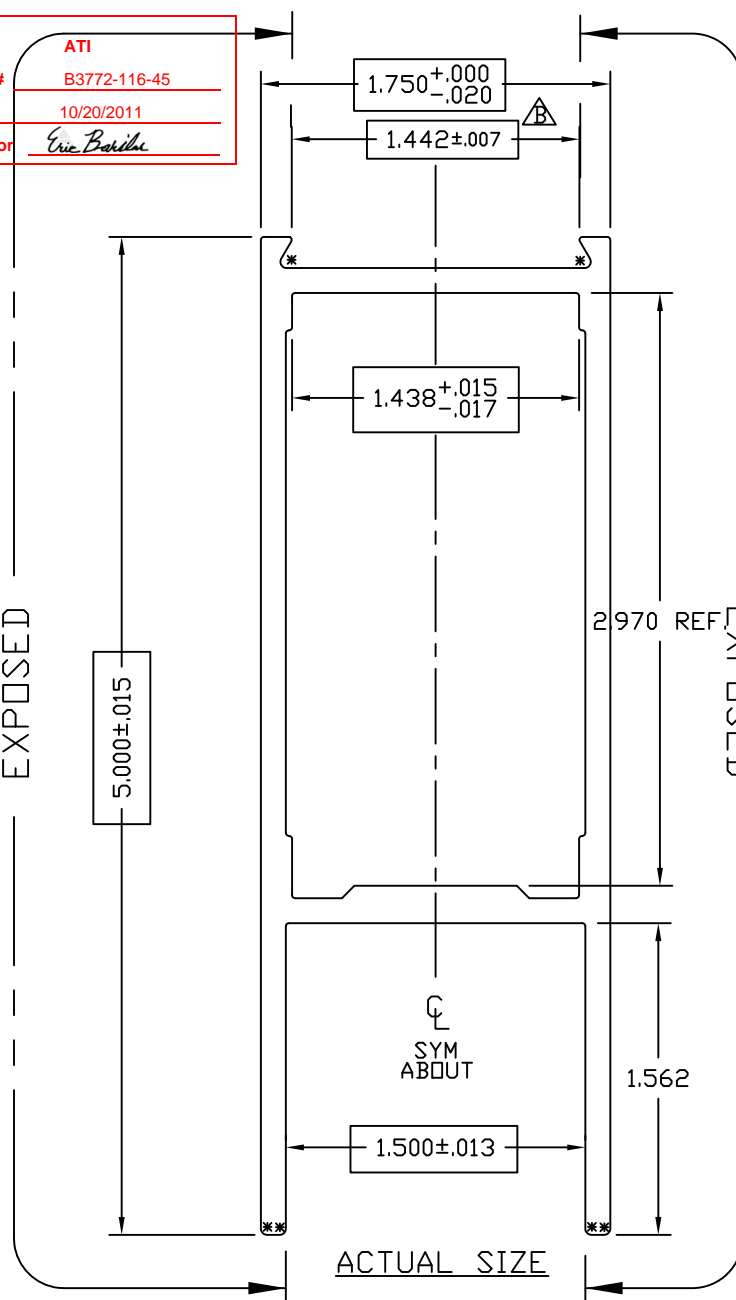

.125 +.003/-0.011 TYP WALL UNLESS NOTED
 SNAP FIT W/E0437(1/4"GLASS) AND E0928(1"GLASS)

© 2006 TUBELITE INC. ALL RIGHTS RESERVED
 ALUMINUM ASSOCIATION STANDARD TOLERANCES APPLY UNLESS NOTED
 ALL UNSPECIFIED RADII .015
 * INDICATES .031 RADIUS
 □ DENOTES CRITICAL DIMENSION
 ALL DIES PROPERTY OF TUBELITE

TUBELITE
 DEPENDABLE
 LEADERS IN ECO-EFFICIENT STOREFRONT,
 CURTAINWALL AND ENTRANCE SYSTEMS

3056 WALKER RIDGE NW, SUITE G
 WALKER, MICHIGAN 49544

WALL THK.	NOTED	SECTION CLASS	H	MAT'L	6063-T5	RATIO	32:1
PERIMETER OUT (TOTAL)	16.983(26.047)		AREA	1.708	WGT/FT	2.008	
FACTOR	13	CIRCLE SIZE	5.282	INFILL VOLUME	N/A		

RXX	.732	SXX	1.046	IXX	.916	CXX	.875
RYY	1.486	SYX	1.432	IYY	3.773	CYY	2.365

HORIZONTAL RAIL 5" X 1 3/4"
 CUSTOM DOORS/FRAME

REV	DATE	DESCRIPTION	INTL
A	11/07/00	+0.00/-0.10 WAS ±0.02	CRH
B	04/10/02	±.007 WAS +0.00/-0.10	CRH

DRAWN BY	DLH	DRWG DATE	04/26/84	APPV'D BY		DATE APPV'D	
DWG SCALE	NOTED	PRODUCT CODE	110	E0318		REV	B

ATI
Report # B3772-116-45
Date 10/20/2011
Simulator Eric Barilko

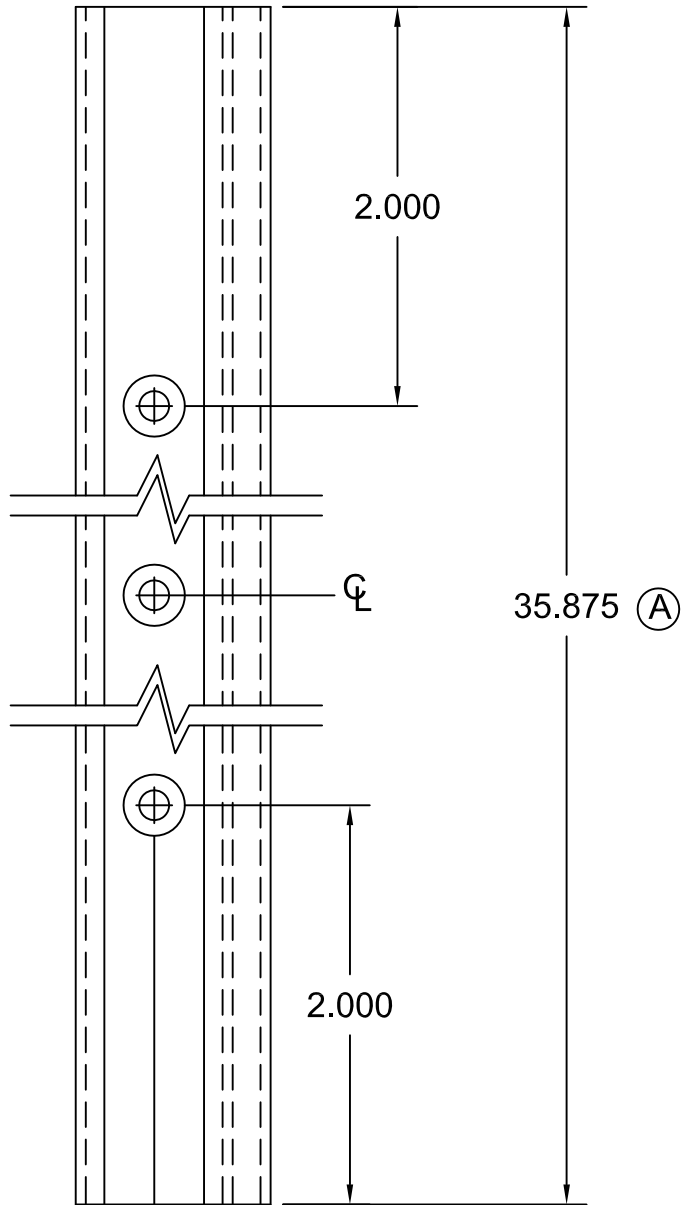

Operations:

1. Cut to length as required from E2059
2. Drill 3 holes with #25 Drl & Ctsk for S-064 (#6 FHCS)
3. Cut P-830 to length, Install, & Crimp ends
4. Cut P-914 to length, and install.
5. Paint ends as required
6. Ship with three (3) S064 Screws.

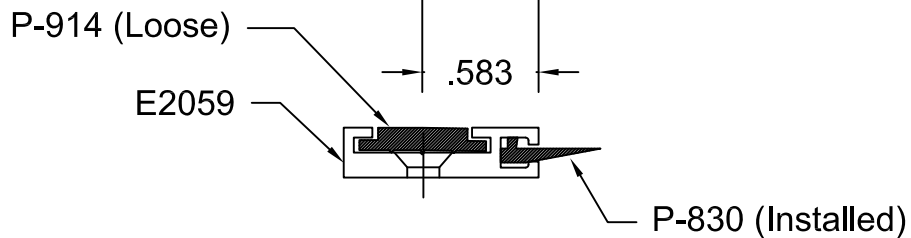

© 2006 TUBELITE INC. ALL RIGHTS RESERVED
 ALL UNSPECIFIED RADII .015
 * INDICATES .031 RADIUS
 □ DENOTES CRITICAL DIMENSION

TUBELITE®
 DEPENDABLE
 LEADERS IN ECO-EFFICIENT STOREFRONT,
 CURTAINWALL AND ENTRANCE SYSTEMS

3056 WALKER RIDGE NW, SUITE G
 WALKER, MICHIGAN 49544

REV	DATE	DESCRIPTION	INTL
	7/29/83	Released Part per ED 128	PJ
A	05/17/90	ED #1222 Dim was 34.875	KMH
B	8/24/01	Redrawn for CAD	DMT
C	06/19/03	OUTSOURCE - ADD S064 SCREWS	SRD

Door Seal to use with
 E2058 Threshold

DRAWN BY PJ	DRWG DATE 05/09/83	APPV,D BY	DATE APPV'D
DRWG SCALE Full	PRODUCT CODE 380	P1275	
			REV C

P1098A

B

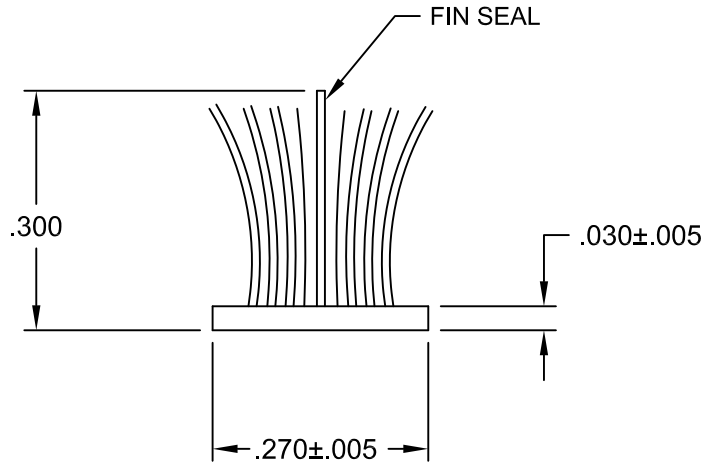

Actual Size

ATI

Report # B3772-116-45

Date 10/20/2011

Simulator Eric Bakula

© 2006 TUBELITE INC. ALL RIGHTS RESERVED

ALL UNSPECIFIED RADII .015

* INDICATES .031 RADIUS

□ DENOTES CRITICAL DIMENSION

TUBELITE®
DEPENDABLE
 LEADERS IN ECO-EFFICIENT STOREFRONT,
 CURTAINWALL AND ENTRANCE SYSTEMS

3056 WALKER RIDGE NW, SUITE G
WALKER, MICHIGAN 49544

REV	DATE	DESCRIPTION	INTL
A	03/08/83	Release Part per ED 109	
B	05/29/02	Redrawn for CAD	DMT

Poly Bond Fin-Seal Weathering
 use with Door Stop E1377

DRAWN BY Don H	DRWG DATE 06/03/83	APPV,D BY	DATE APPV'D	REV
DRWG SCALE Noted	PRODUCT CODE 380	P1098A		B

ATI

Report # B3772-116-45

Date 10/20/2011

Simulator Eric Bakula

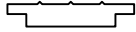

ACTUAL SIZE

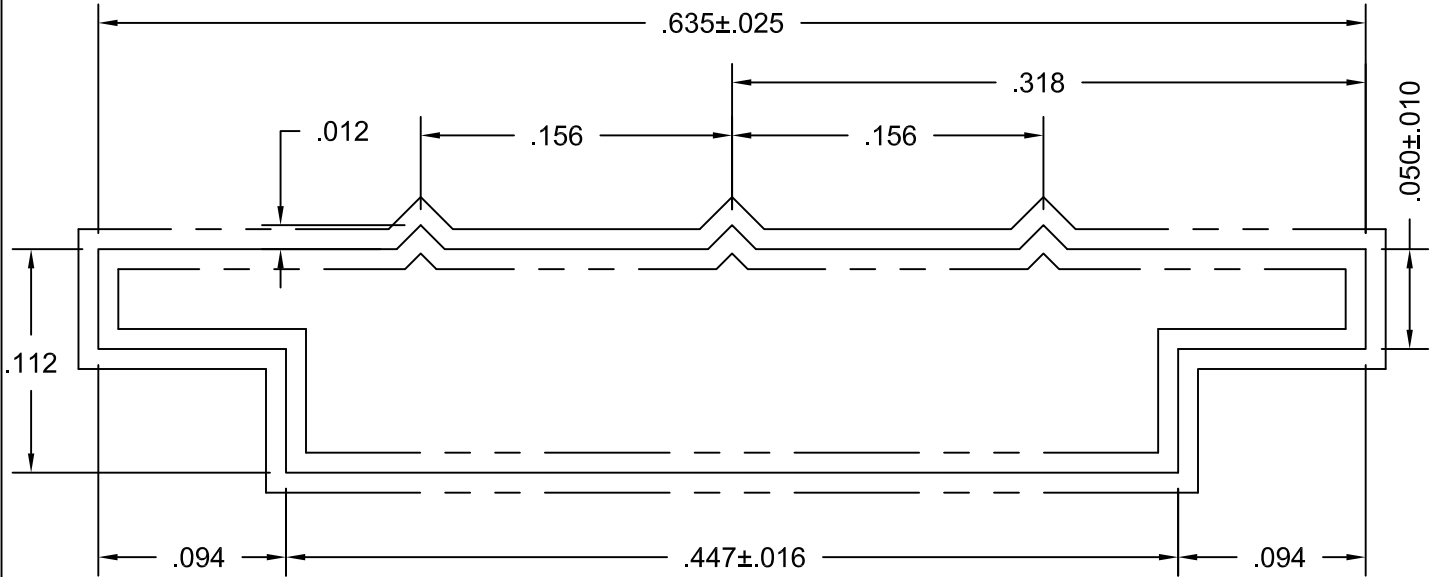

Ten Times Size

NOTE: Part to receive Silicone Bath after Extruding

Purchased Part
Avon Rubber
90 Durometer
250' Rolls

© 2006 TUBELITE INC. ALL RIGHTS RESERVED

ALL UNSPECIFIED RADII .015

* INDICATES .031 RADIUS

□ DENOTES CRITICAL DIMENSION



3056 WALKER RIDGE NW, SUITE G
WALKER, MICHIGAN 49544

REV	DATE	DESCRIPTION	INTL
A	01/19/96	Redrawn for AutoCAD	DMT

<p>EPDM Rubber Glazing Use with M1061, M1063, M1202</p>			
DRAWN BY	KMH	DRWG DATE	01/19/96
APPV,D BY		DATE APPV'D	
DRWG SCALE	Noted	PRODUCT CODE	380
<p>P914</p>			<p>REV A</p>

P0017
E

ATI
 Report # B3772-116-45
 Date 10/20/2011
 Simulator Eric Borille

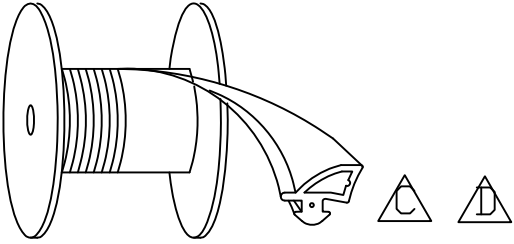

Material must UNREEL like this...

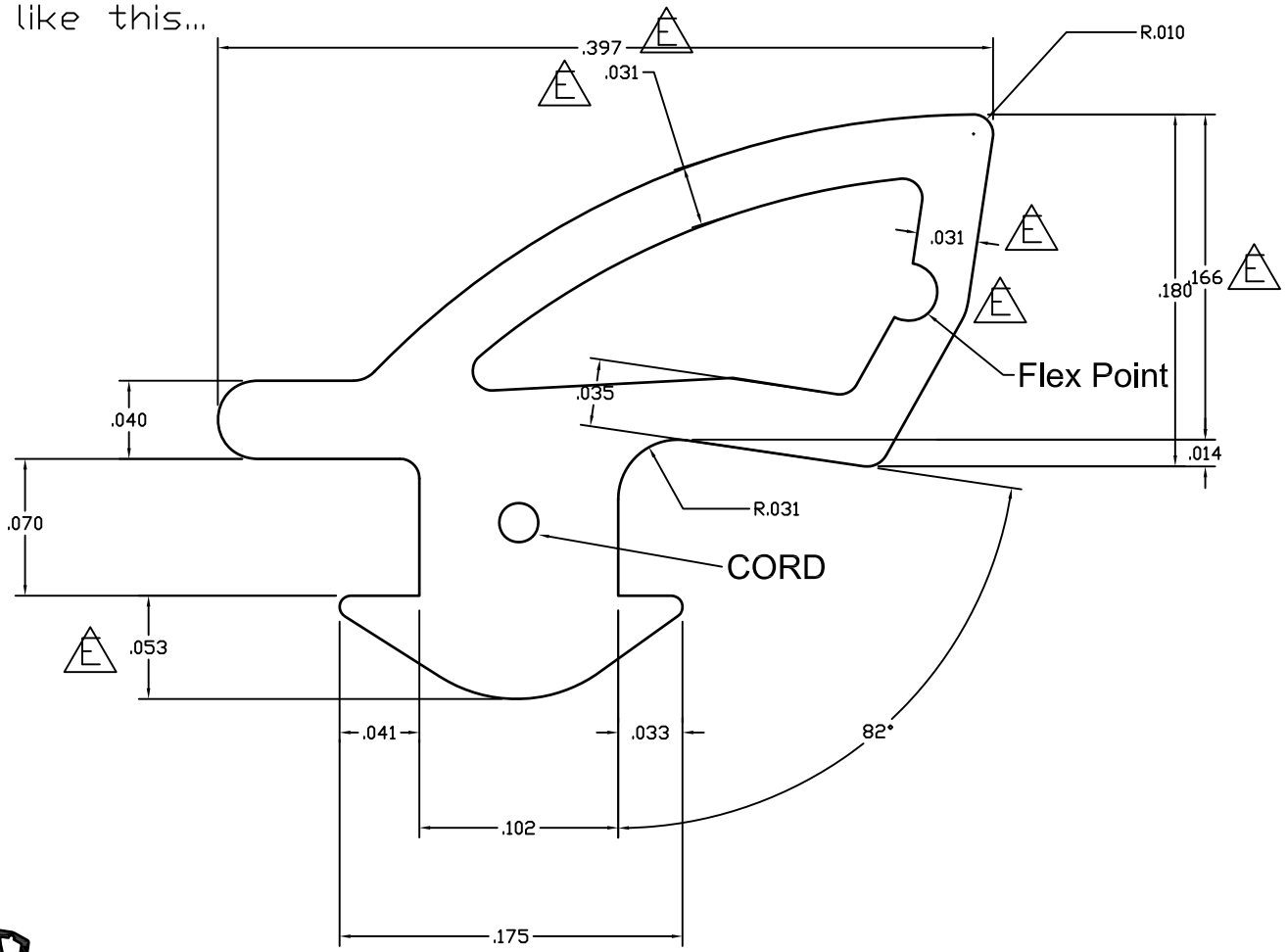

ACTUAL SIZE

MATERIAL: EPDM 60 DUROMETER WITH CORD

©2006 TUBELITE INC. ALL RIGHTS RESERVED
 ALL UNSPECIFIED RADII .015
 * INDICATES .031 RADIUS
 □ DENOTES CRITICAL DIMENSION

TUBELITE
 DEPENDABLE
 LEADERS IN ECO-EFFICIENT STOREFRONT,
 CURTAINWALL AND ENTRANCE SYSTEMS

3056 WALKER RIDGE NW, SUITE G
 WALKER, MICHIGAN 49544

REV	DATE	DESCRIPTION	INTL
A	08/20/07	MODIFIED DART: .070 WAS .060 AND .051 WAS .061 ADDED CORD	NIK
B	10/16/08	ADDED MANUFACTURER'S TOLERANCES FOR REFERENCE	SRD
C	10/22/10	Modified gasket position of how the reel should roll	TT
D	12/16/10	Modified gasket position of how the reel should roll	TT
E	02/15/11	Rev flex pt, thickness was .032, .180 was .188	TT

1/4"-1" DOOR GLAZING GASKET
 500' ROLLS

DRAWN BY NIK	DRWG DATE 4-17-07	APPV.D BY	DATE APPV'D	REV
DRWG SCALE 10X	PRODUCT CODE 100	P0017		E

ATI

Report # B3772-116-45

Date 10/20/2011

Simulator Eric Barilac

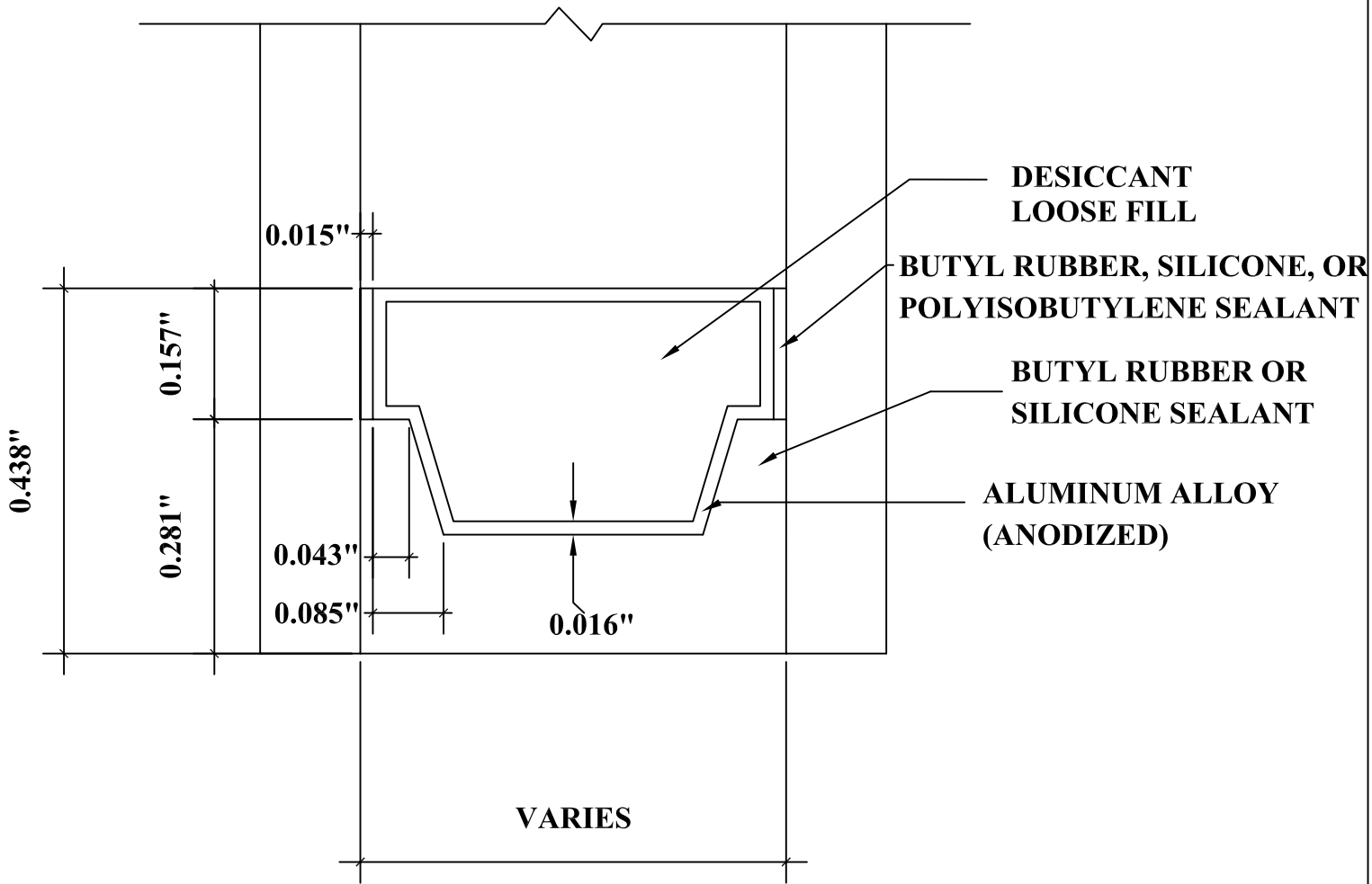

DETAIL FOR THERMAL MODELING OF
ALUMINUM SPACER (A1-D)