

Glazings & Door Stops

Glazings for 1/2" - 7/8" Infill

CAD DETAIL FILE NO.
370GS001

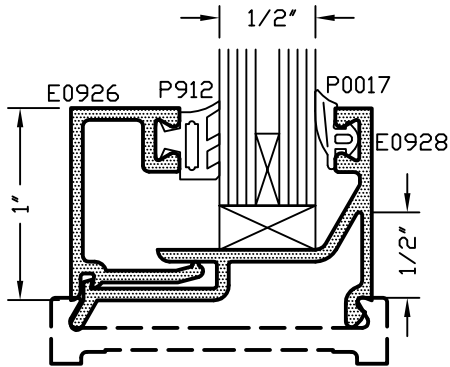

1/2" INFILL

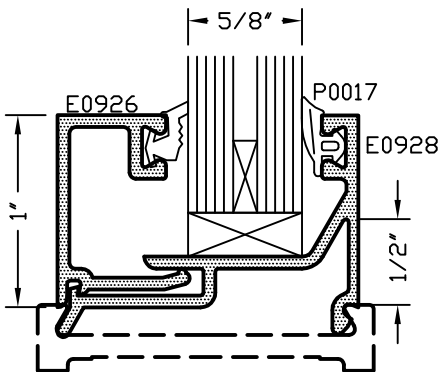
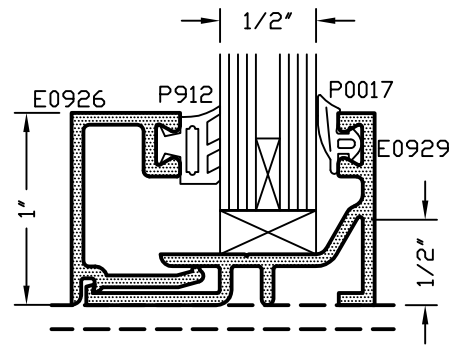

5/8" INFILL

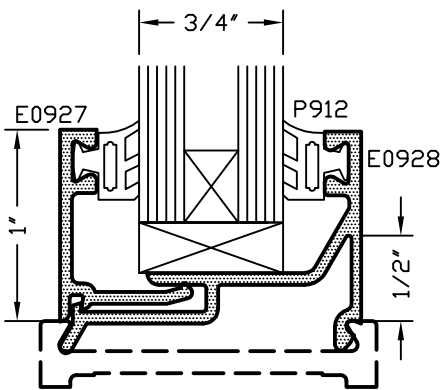
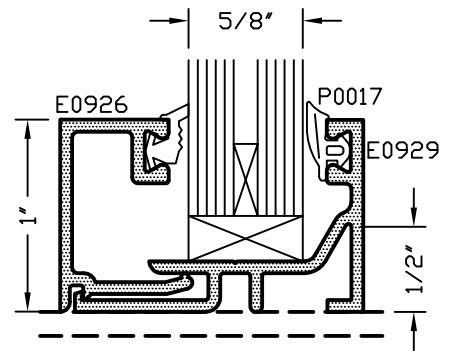

3/4" INFILL

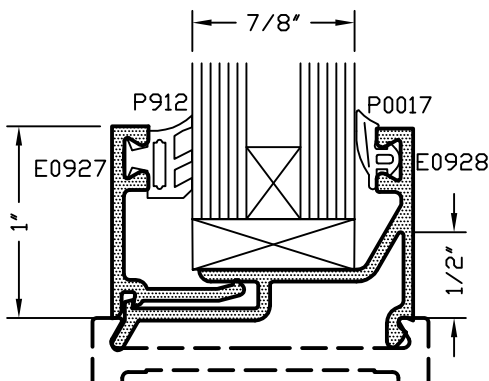
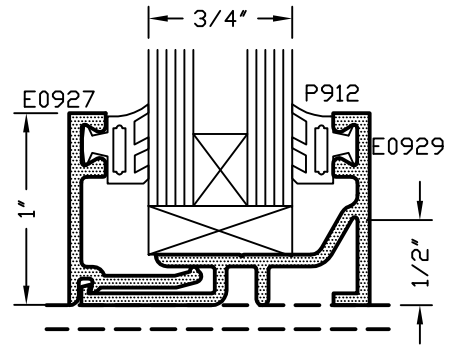

7/8" INFILL

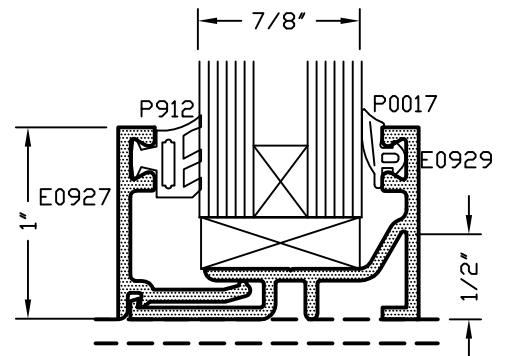

*SETTING BLOCKS SHOWN ARE NOT BY TUBELITE

9.02

Glazings for Door Stops

Glazings for 1" Infill and Miscellaneous

CAD DETAIL FILE NO.
370GS002

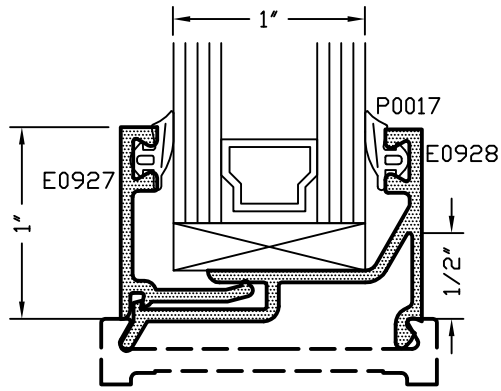

1" INFILL

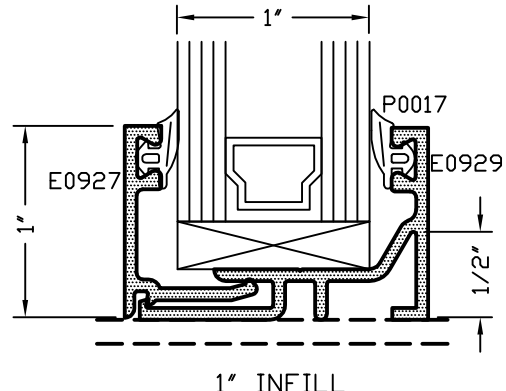

1" INFILL

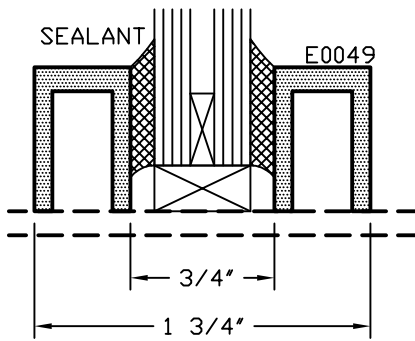

1/2" INFILL
WITH CHANNEL STOPS

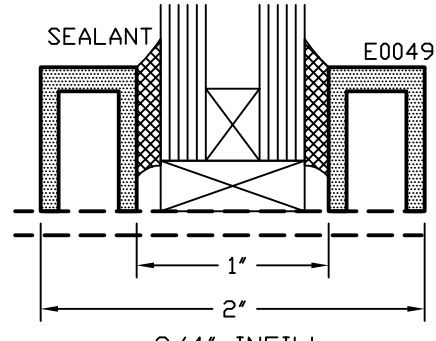

3/4" INFILL
WITH CHANNEL STOPS

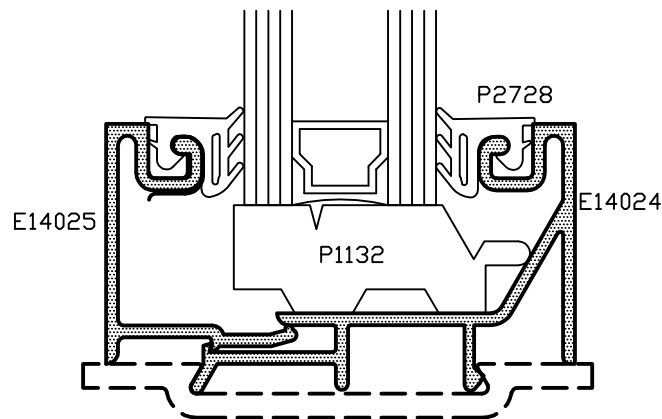

ANY DOVETAIL TUBE

*SETTING BLOCKS SHOWN ARE NOT BY TUBELITE UNLESS NOTED WITH A PART NUMBER

Glazings & Door Stops

Glazings for 1/4" - 3/8" Infill

CAD DETAIL FILE NO.
370GS003

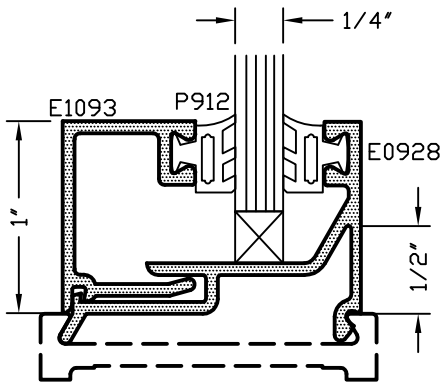

1/4" INFILL

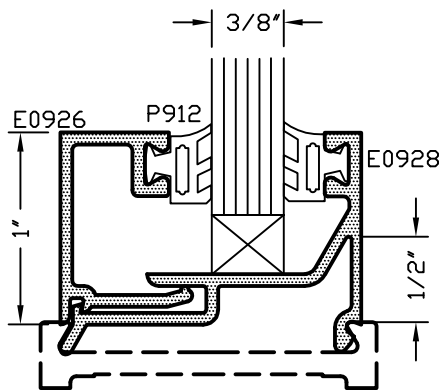
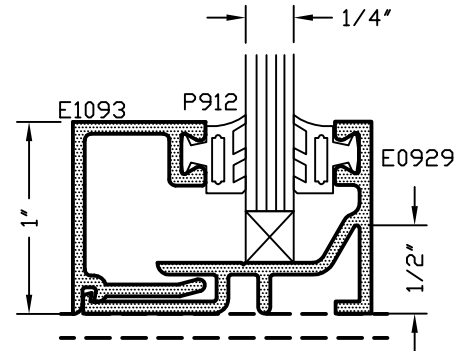

3/8" INFILL

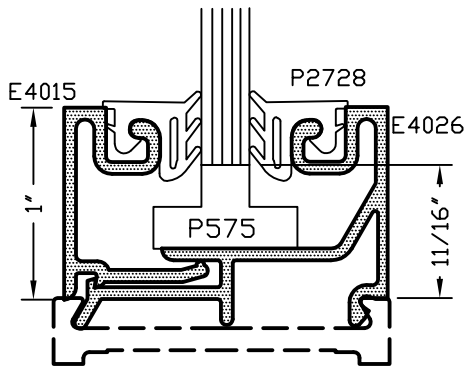
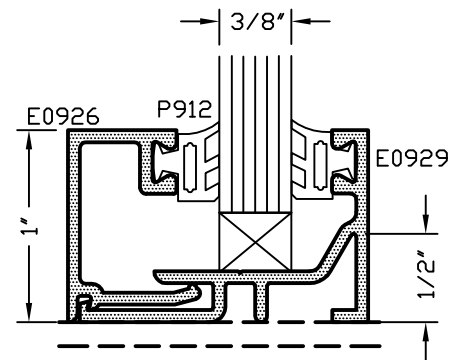

GLASS THICKNESS	USE GLAZING
3/16", 7/32", 1/4"	P2528 BOTH SIDES
5/16"	P487 & P2528
3/8"	P487 BOTH SIDES

SETTING BLOCK NUMBER P575 FOR
3/16", 7/32", & 1/4" GLASS

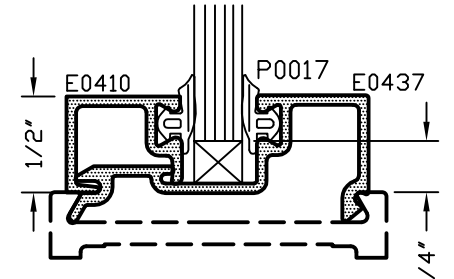
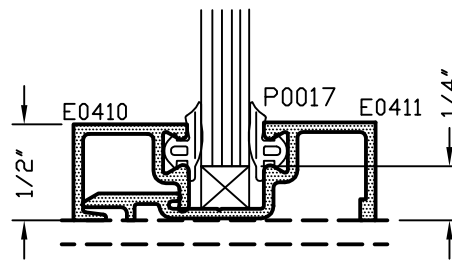
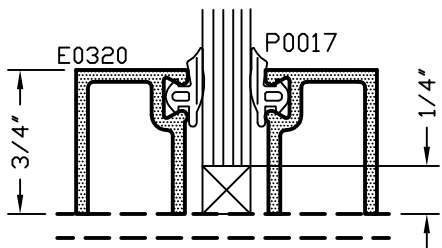
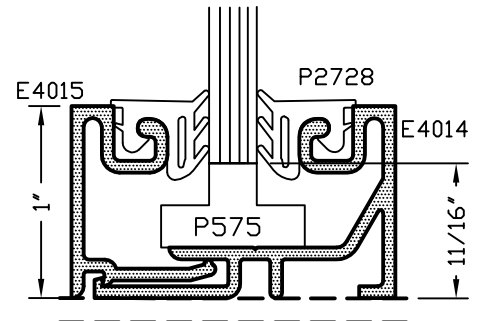

FOR 1/4" GLASS ONLY

*SETTING BLOCKS SHOWN ARE NOT BY TUBELITE UNLESS NOTED WITH A PART NUMBER

9.04

Sidelight Base

Sidelight Base for 1" Infill

CAD DETAIL FILE NO.
370GS004

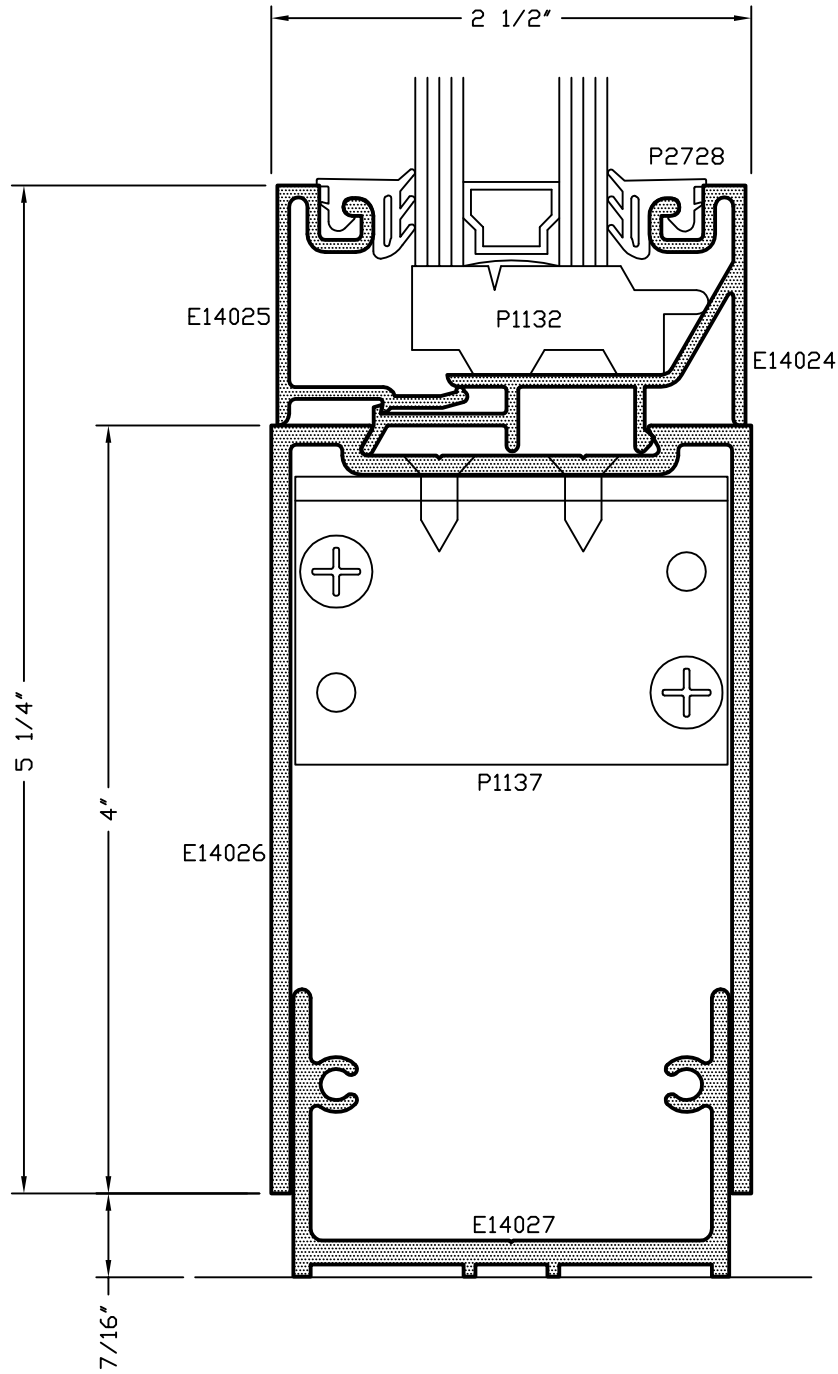

9.05

Sidelight Bases Sidelight Base for 1/4" Infill

CAD DETAIL FILE NO.
370GS005

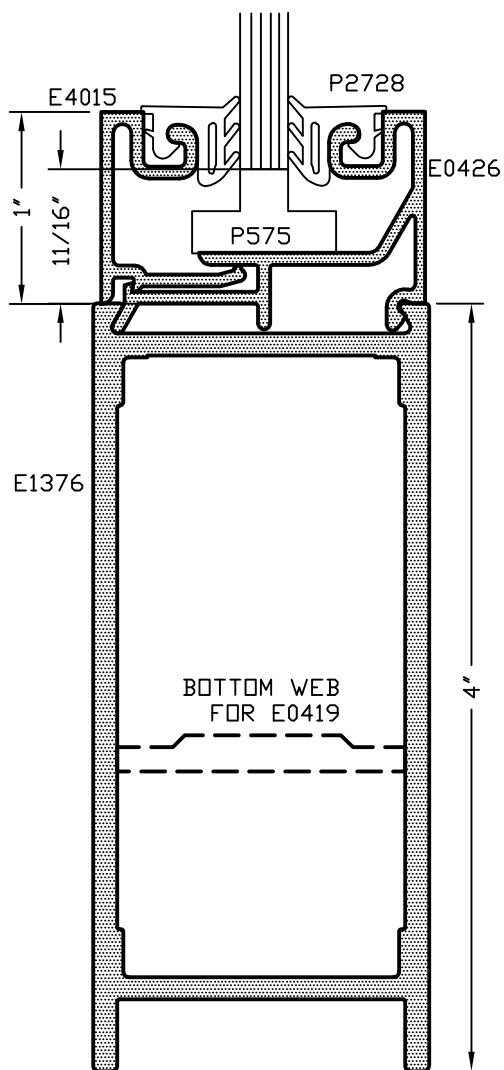

THIS IS STANDARD ARRANGEMENT FOR A SIDELIGHT BASE WHEN DOOR DOES NOT HAVE A THRESHOLD.

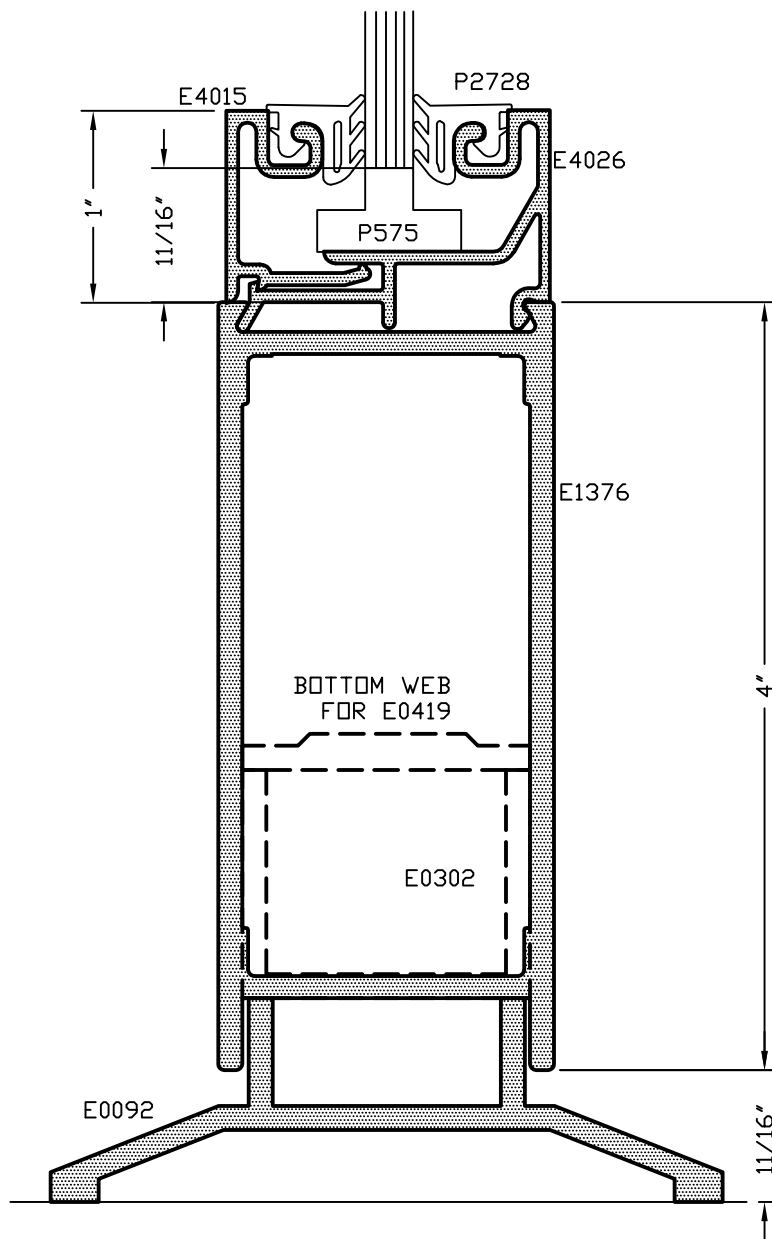

THIS IS STANDARD ARRANGEMENT FOR A SIDELIGHT WHEN DOOR HAS A THRESHOLD.

*SEALANT, ROD, & ANCHORS NOT BY TUBELITE

9.06

Sidelight Bases, Glazings & Door Stops

Door Stops

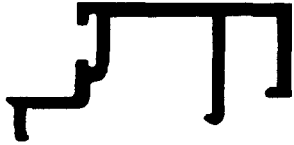

E 4531

1/2" high stop, for Standard 1 3/4" thick doors with 3/16" reveal. Use with 4500 Series & 14000 Series Flush Glaze door frames and P 1098 pile weathering.

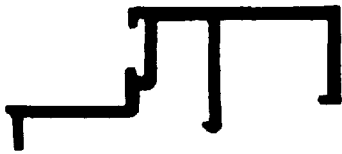

E 4031

1/2" high stop, for Standard 1 3/4" thick doors with 3/16" reveal. Use with 4000 Series Flush Glaze door frames and P 1098 pile weathering.



E 2942

1/2" high stop, for Monumental 2" thick doors with no reveal. Use with 4500 Series & 14000 Series Flush Glaze door frames and P 1098 pile weathering.

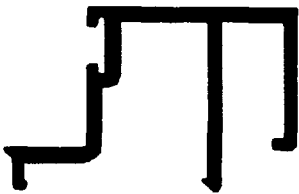

E 2940

3/4" high stop, for Monumental 2" thick doors with no reveal. Use with 4500 Series & 14000 Series Flush Glaze door frames and P 1098 pile weathering.

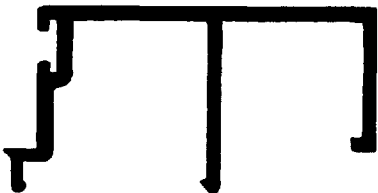

E 4558

3/4" high stop, for Standard 1 3/4" thick doors with no reveal. Use with 4500 Series & 14000 Series Flush Glaze door frames and P 1098 pile weathering.



E 4557

1/2" high stop, for Standard 1 3/4" thick doors with no reveal. Use with 4500 Series & 14000 Series Flush Glaze door frames and P 1098 pile weathering.

Sidelight Bases, Glazings & Door Stops**Door Stops****E 1377**

1/2" high stop, for Standard 1 3/4" thick doors with 3/16" reveal. Use with 4 1/2" Dovetail Series door frames and P 1098 pile weathering.

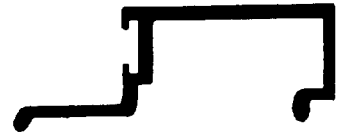
**E 0859**

1/2" high stop, for Standard 1 3/4" thick doors with 3/16" reveal. Use with E 0854 Dovetail Series door frame and P 013A pile weathering.

**E 2911**

1/2" high stop, for Standard 1 3/4" thick doors with no reveal. Use with VersaTherm Series door frames and P 1098 pile weathering.

**E 2672**

3/4" high stop, for Standard 1 3/4" thick doors with 3/16" reveal. Use with 4 1/2" Dovetail Series door frames and P 1098 pile weathering.

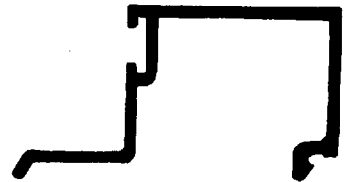
**E 2300**

1/2" high stop, for Standard & Monumental doors with 3/16" reveal. Snap-fits with E 2299 screw-applied base on smooth face door frames. Use with P1098 pile weathering.

**E 2686**

3/4" high stop, for Standard & Monumental doors with 3/16" reveal. Snap-fits with E 2299 screw-applied base on smooth face door frames. Use with P 1098 pile weathering.

**E 2299**

Screw-applied base for use with E 2300 & E 2686 on smooth face door frames. Use with S 064 screw.



9.08

Sidelight Bases, Glazings & Door Stops

Door Stops



E 3031

1/2" high x 25/32" wide screw applied stop, for Standard & Monumental doors. Use with S 045 screw and P 1098 pile weathering.



E 1572

1/2" high x 1 3/32" wide screw applied stop, for Standard & Monumental doors. Use with S 045 screw and P 1098 pile weathering.



E 1573

1/2" high x 1 3/4" wide screw applied stop, for Standard & Monumental doors. Use with S 045 screw and P 1098 pile weathering.

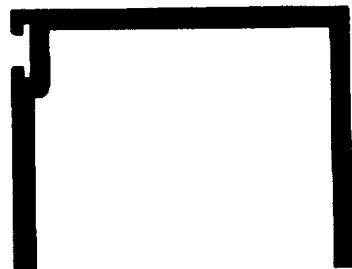

E 2298

1 3/8" high x 1 3/4" wide screw applied stop, for Standard & Monumental doors with Concealed Overhead Closers. Use with S 303 screw and P 1098 pile weathering.