

E14000 I/O Storefront

E14302 and E14306 Wind Load Chart

CAD DETAIL FILE NO.
E14302 E14306 WLC

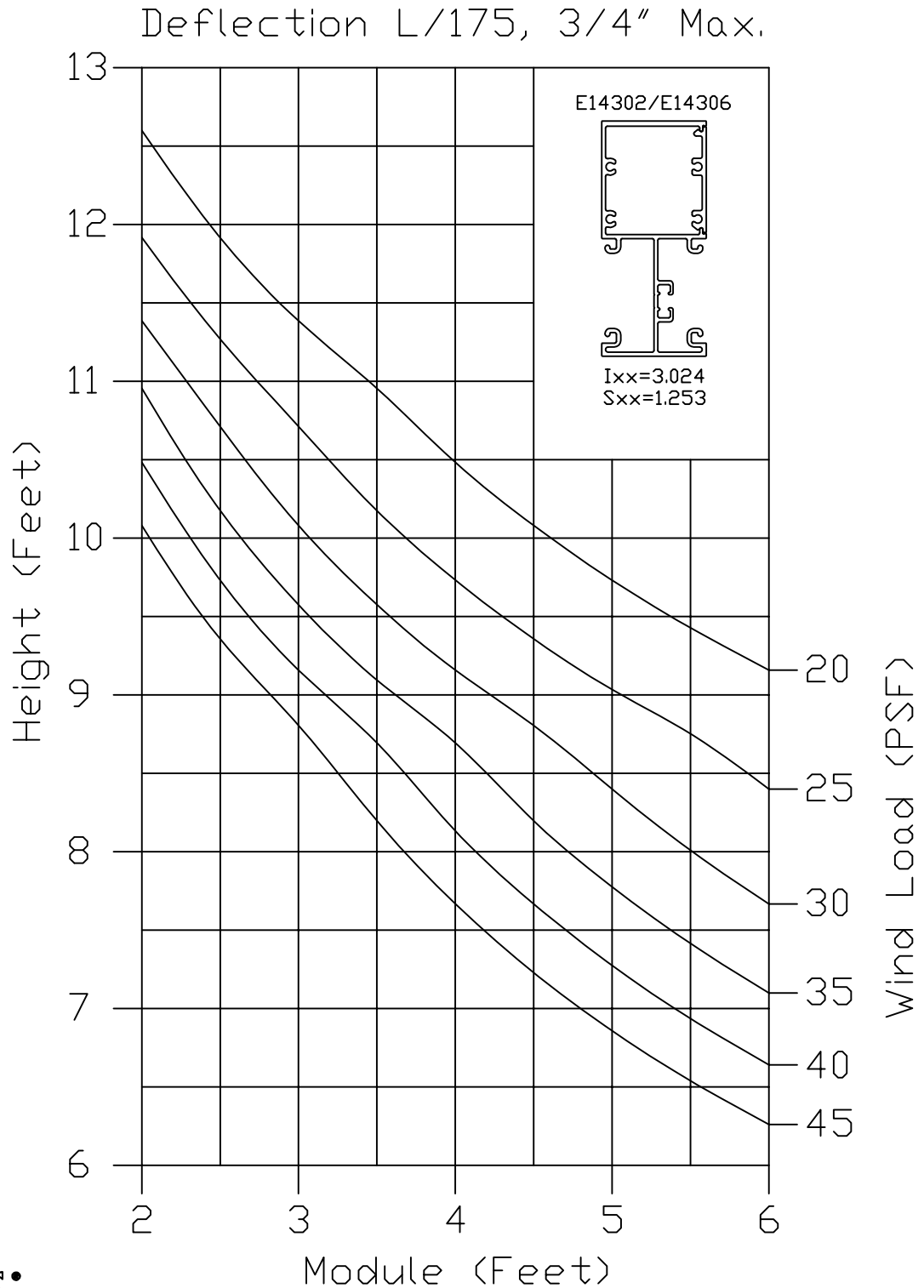

E14000 I/O Storefront

E14302 and E14356 Wind Load Chart

CAD DETAIL FILE NO.
E14302 E14356 WLC

Deflection $L/175$, $3/4"$ Max.

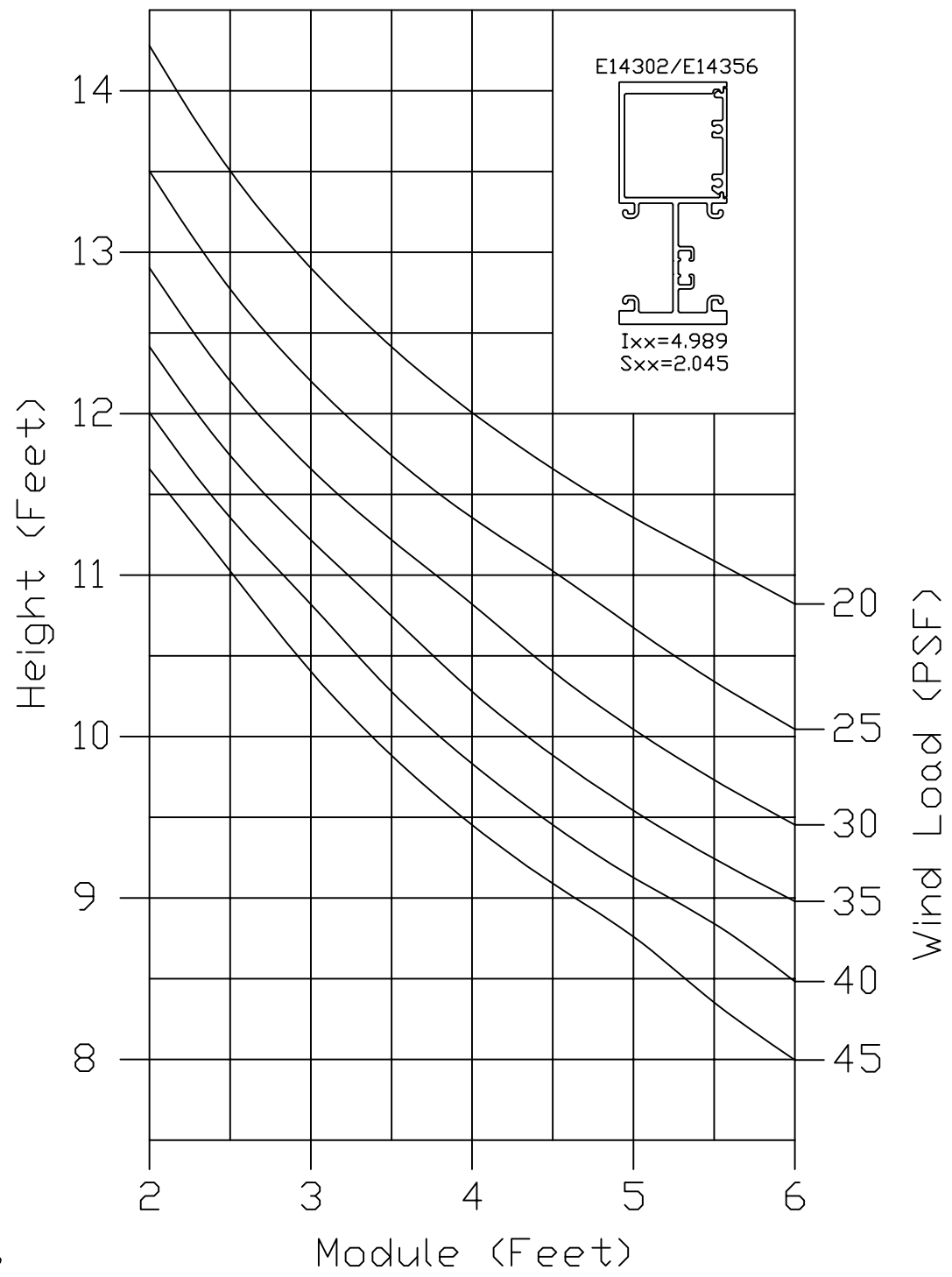

*SEALANT, ROD, & ANCHORS NOT BY TUBELITE

E14000 I/O Storefront

E14305 and E14312 Wind Load Chart

CAD DETAIL FILE NO.
E14305 E14312 WLC

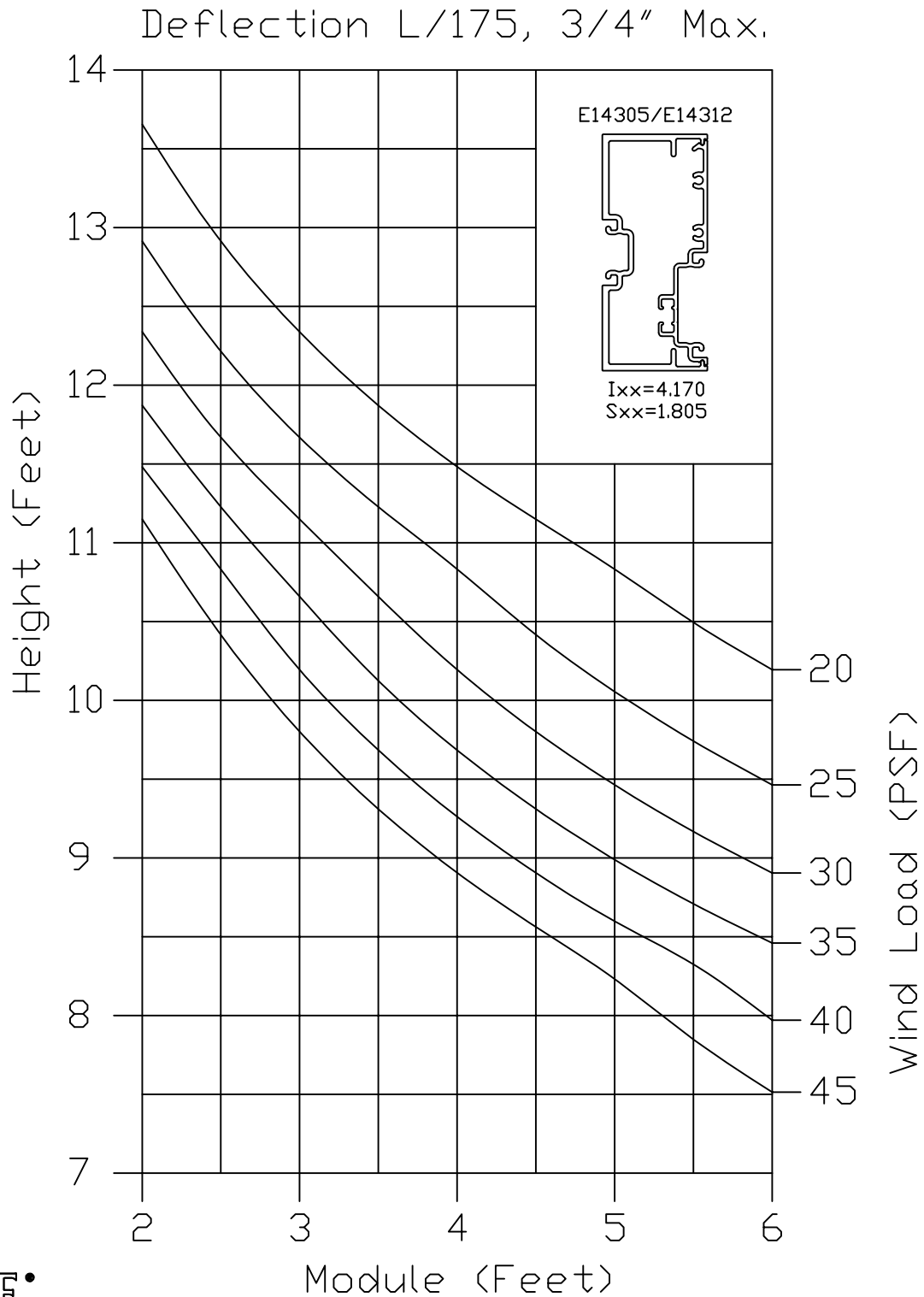

E14000 I/O Storefront

E14305 and E14322 Wind Load Chart

CAD DETAIL FILE NO.
E14305 E14322 WLC

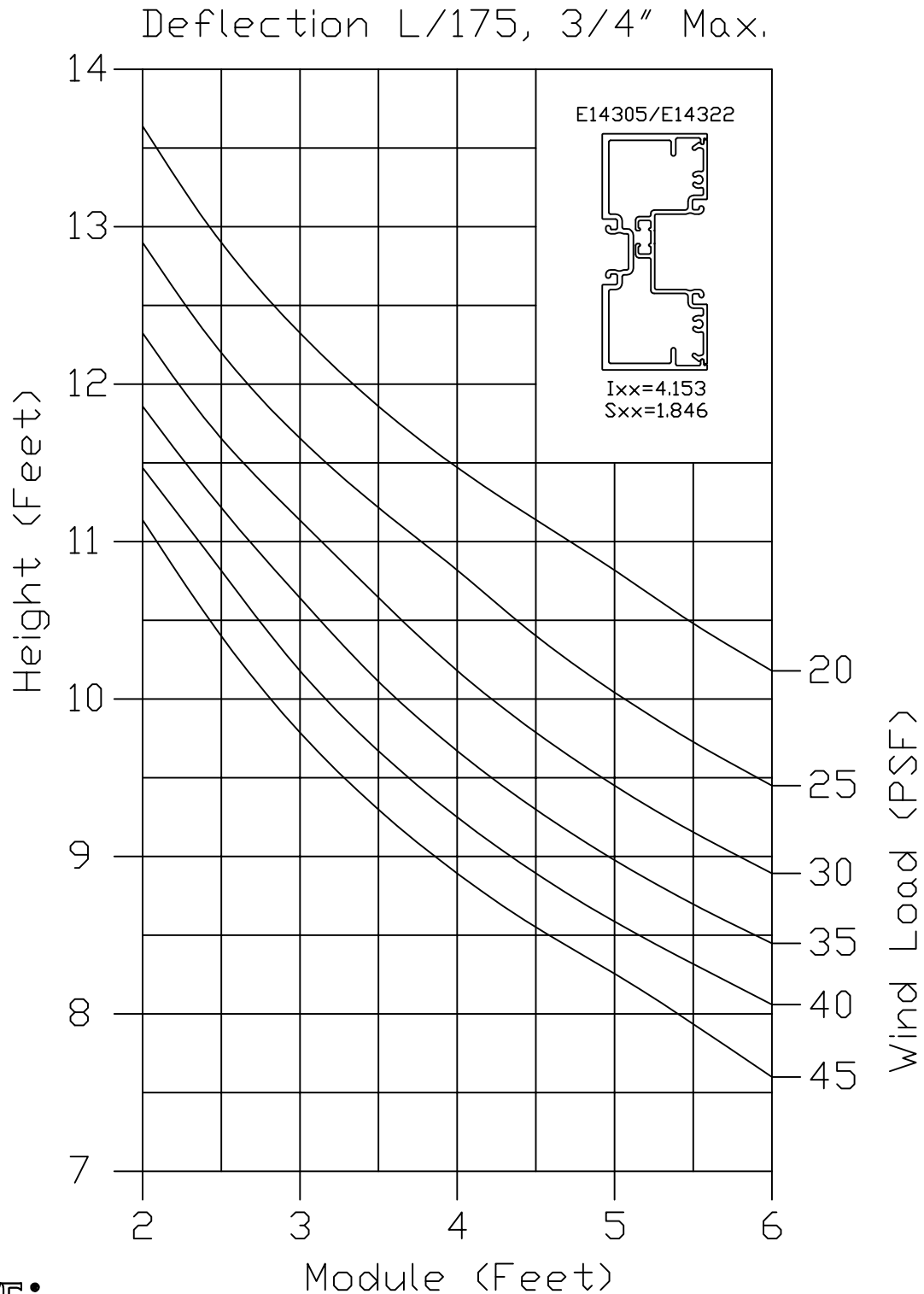

E14000 I/O Storefront

E14305 and E14332 Wind Load Chart

CAD DETAIL FILE NO.
E14305 E14332 WLC

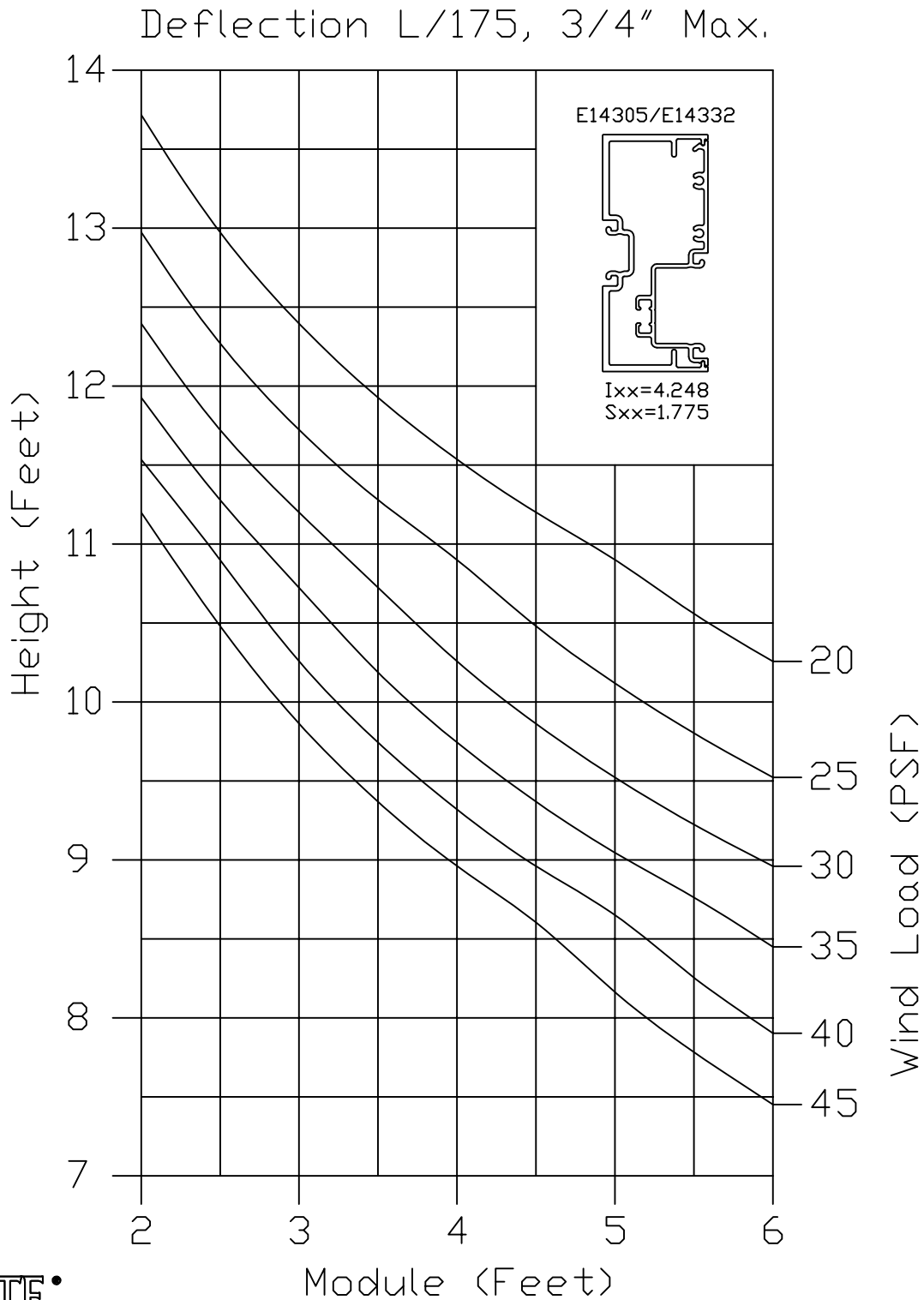

E14000 I/O Storefront

E14311 and E14312 Wind Load Chart

CAD DETAIL FILE NO.
E14311 E14312 WLC

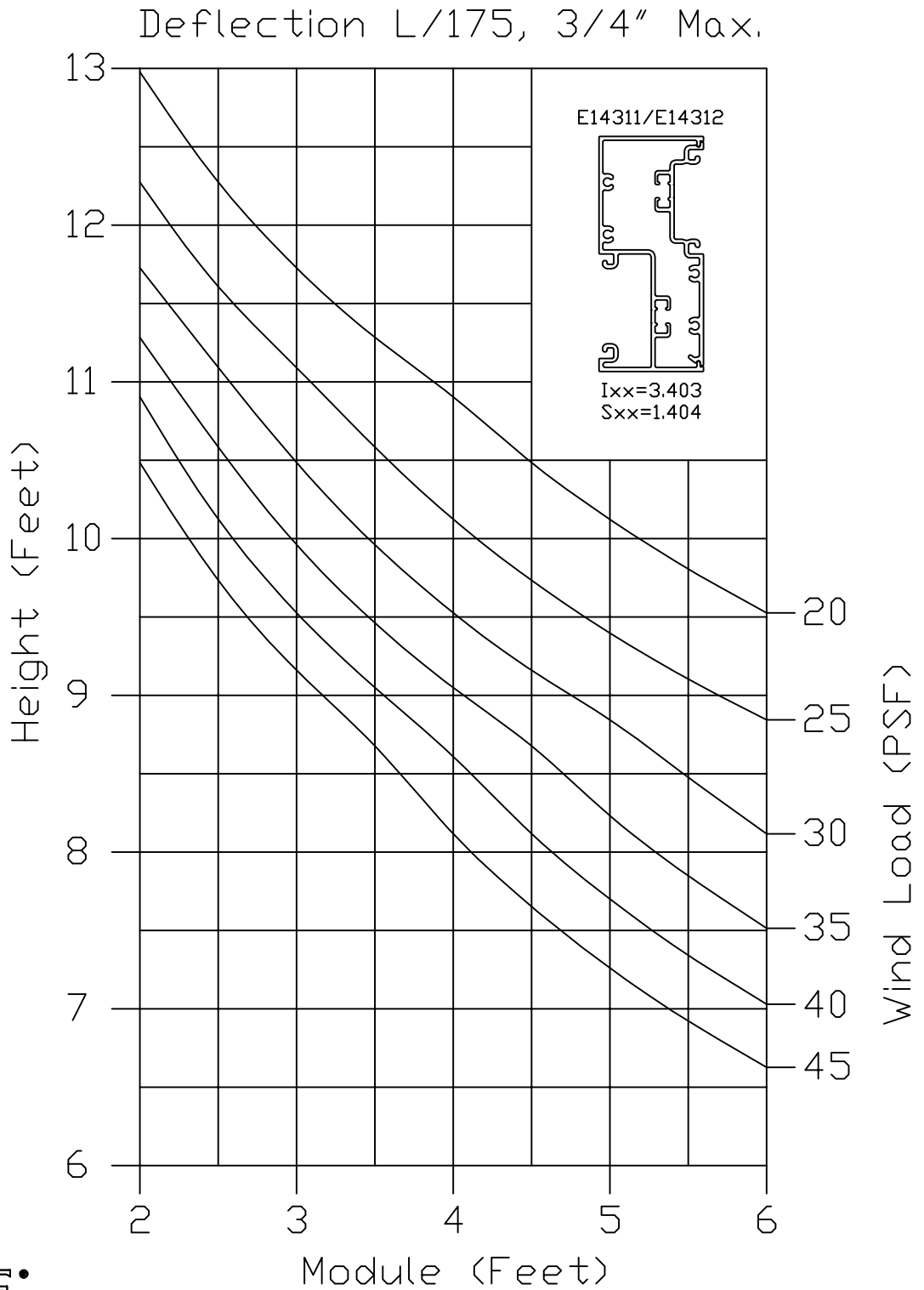

*SEALANT, ROD, & ANCHORS NOT BY TUBELITE

E14000 I/O Storefront

E14312 and E14321 Wind Load Chart

CAD DETAIL FILE NO.
E14312 E14321 WLC

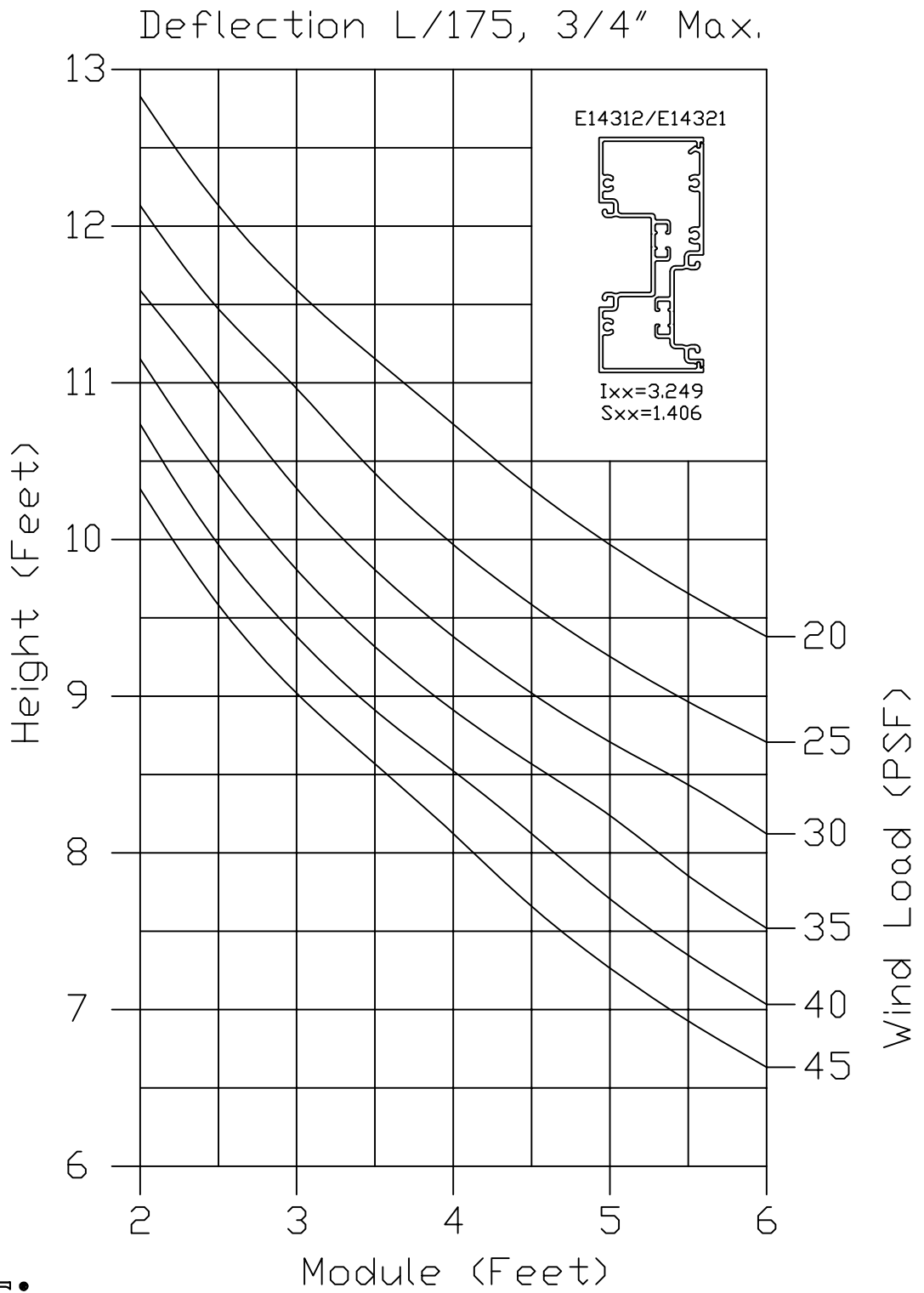

*SEALANT, ROD, & ANCHORS NOT BY TUBELITE

E14000 I/O Storefront

E14326 Wind Load Chart

CAD DETAIL FILE NO.
E14326 WLC

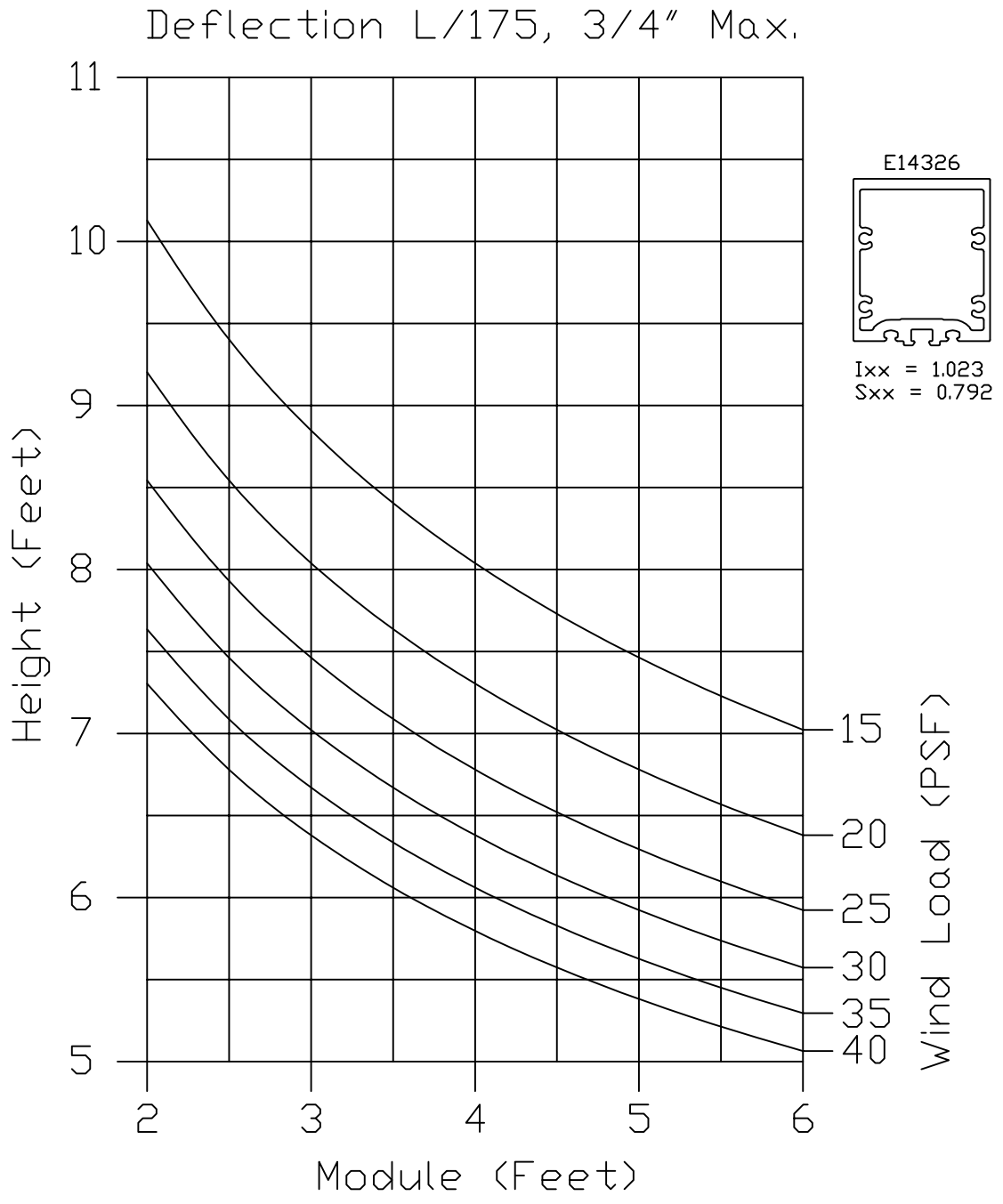

E14000 I/O Storefront

E14336 and E14346 Wind Load Chart

CAD DETAIL FILE NO.
E14336 E14346 WLC

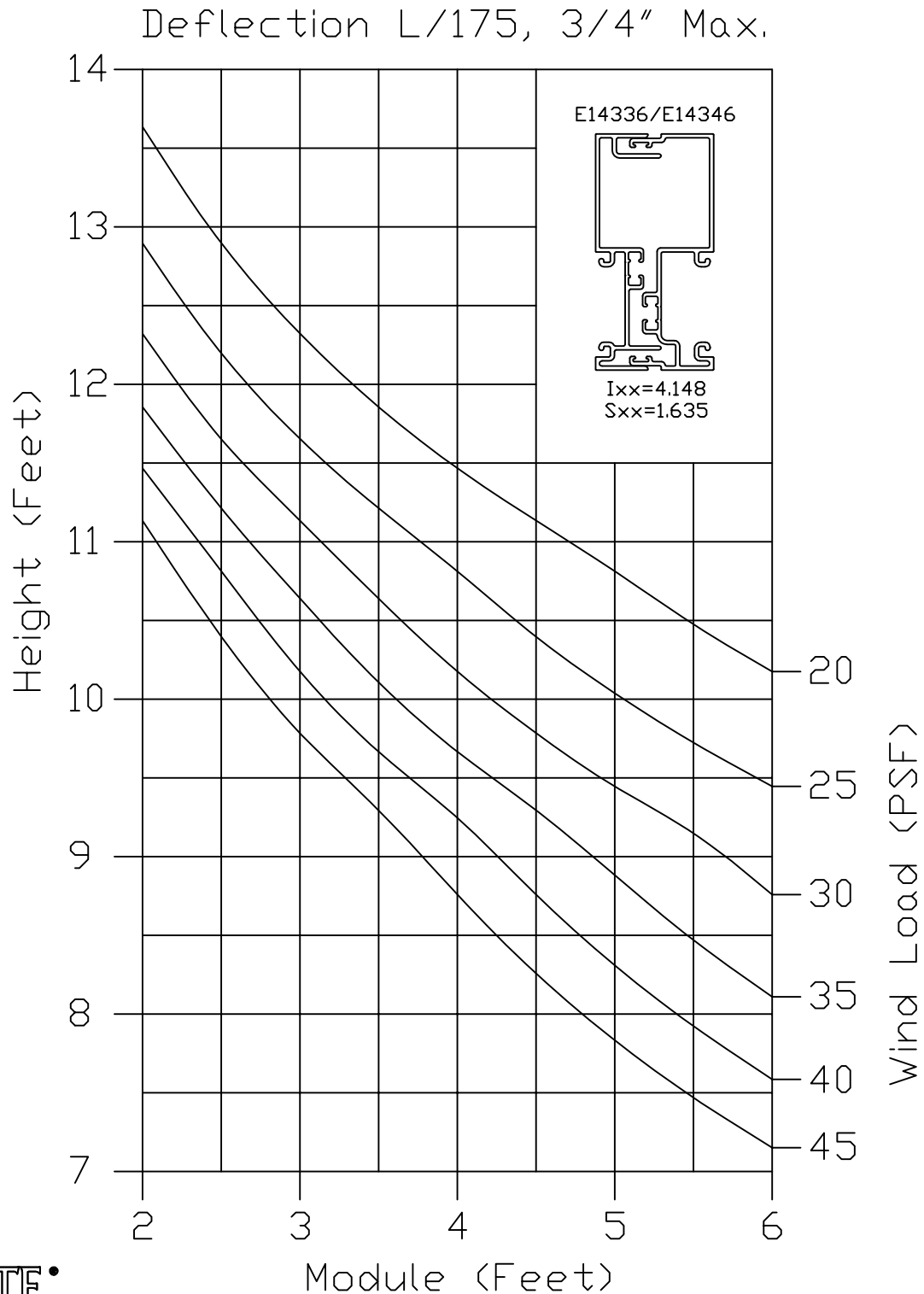

E14000 I/O Storefront

E14366 Wind Load Chart

CAD DETAIL FILE NO.
E14366 WLC

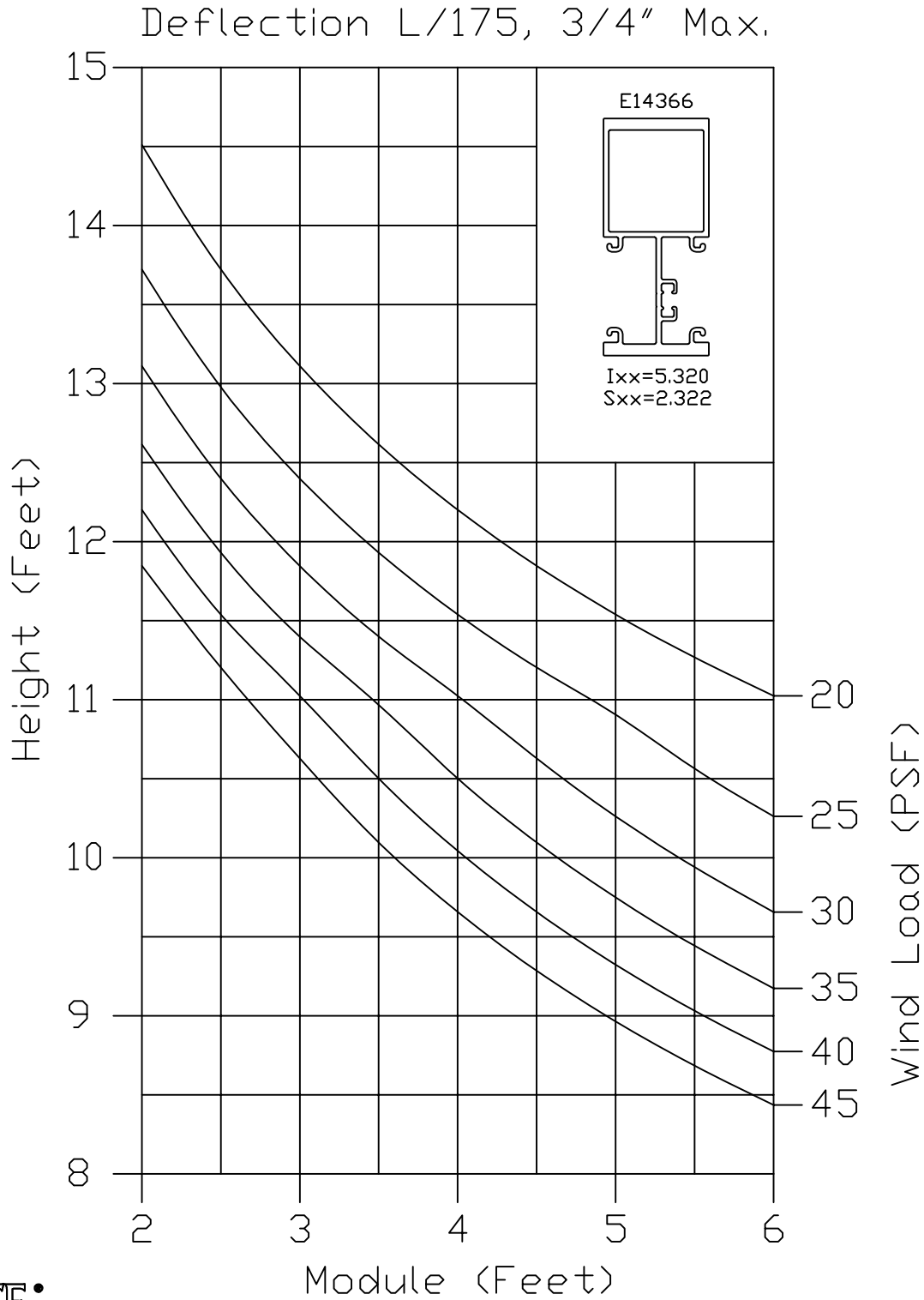

T14000 I/O Storefront

E14302 and T14306 Wind Load Chart

CAD DETAIL FILE NO.
E14302 T14306 WLC

Deflection $L/175$, $3/4"$ Max.

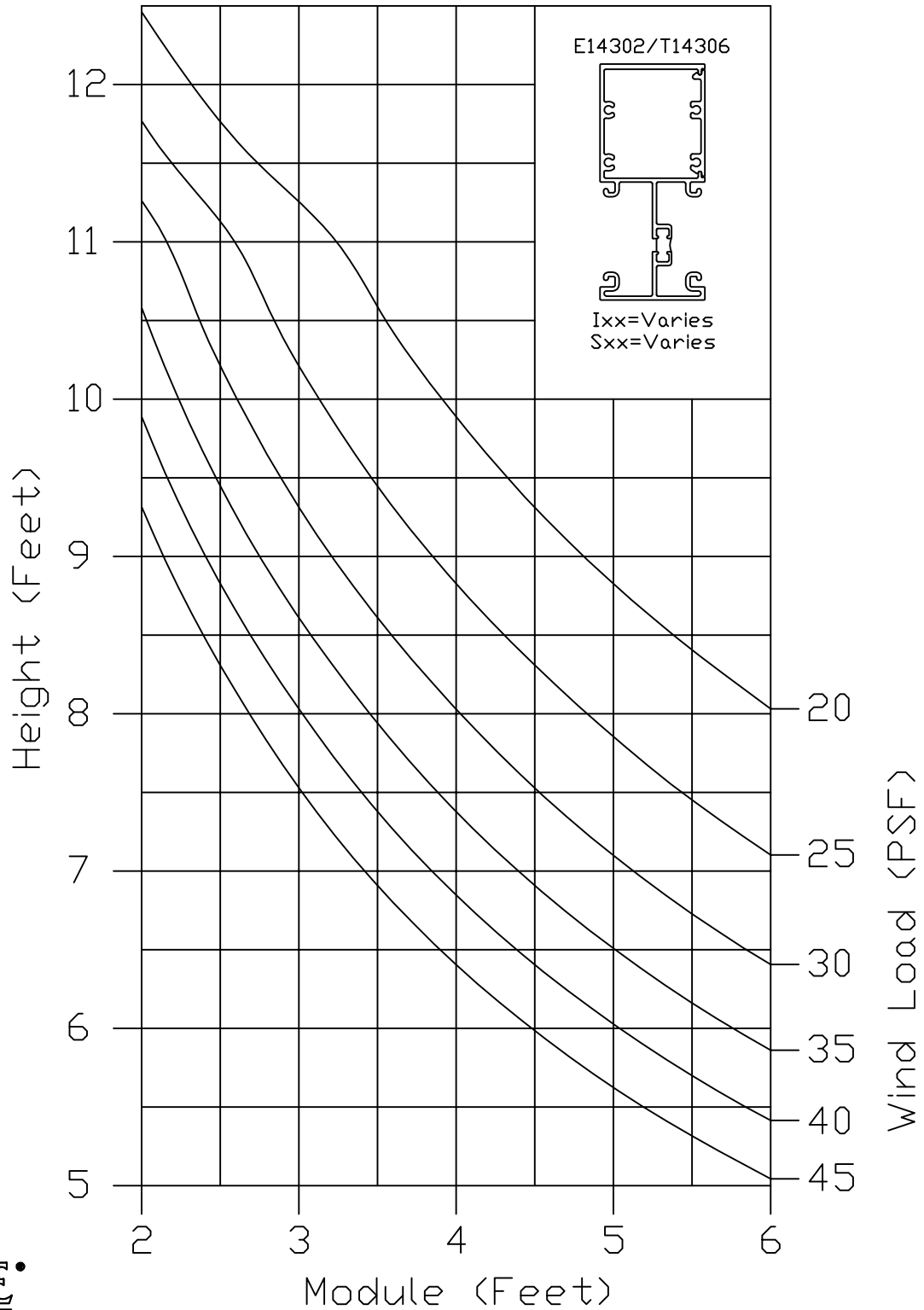

T14000 I/O Storefront

E14305 and T14312 Wind Load Chart

CAD DETAIL FILE NO.
E14305 T14312 WLC

Deflection L/175, 3/4" Max.

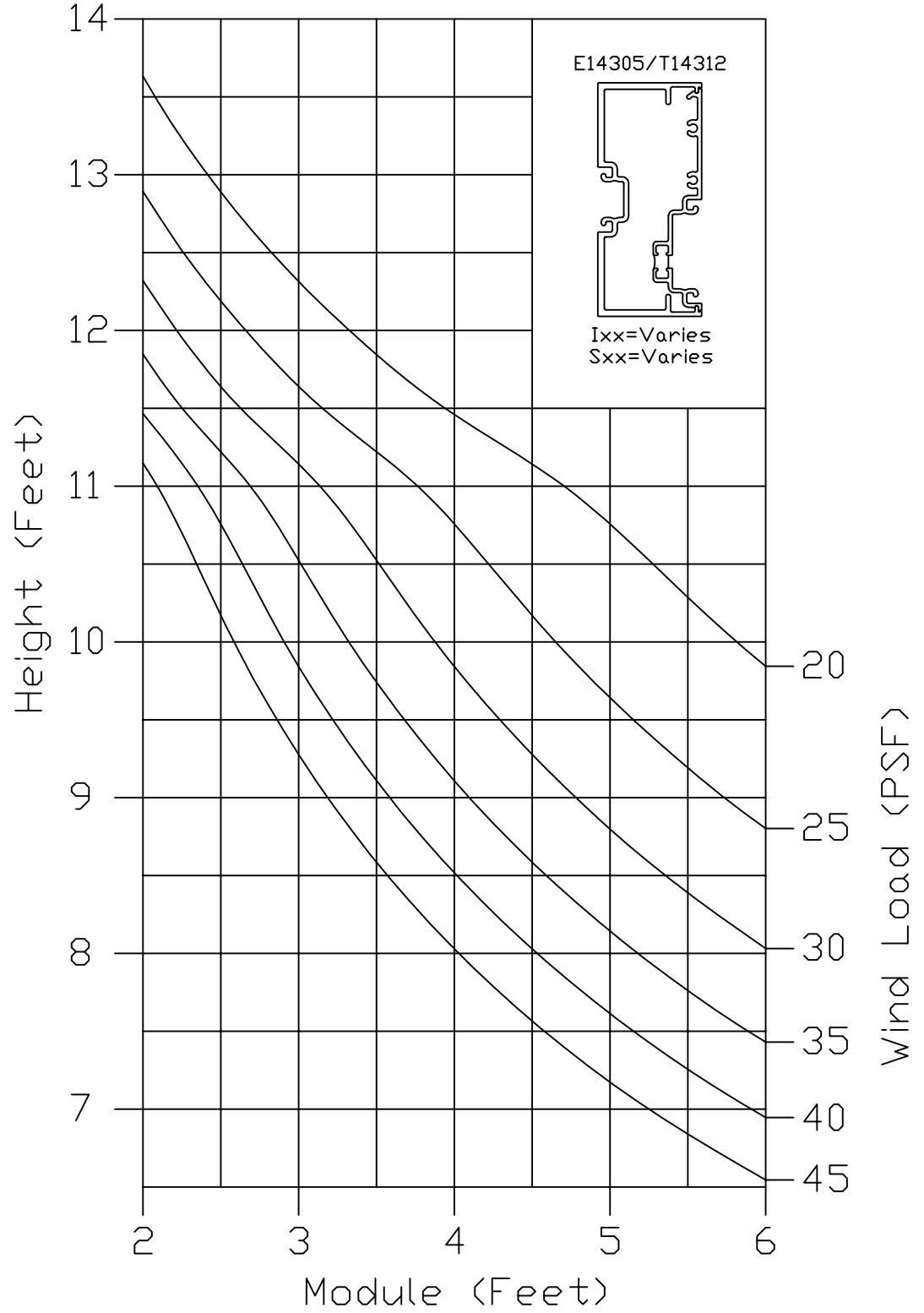

*SEALANT, ROD, & ANCHORS NOT BY TUBELITE

T14000 I/O Storefront

E14305 and T14322 Wind Load Chart

CAD DETAIL FILE NO.
E14305 T14322 WLC

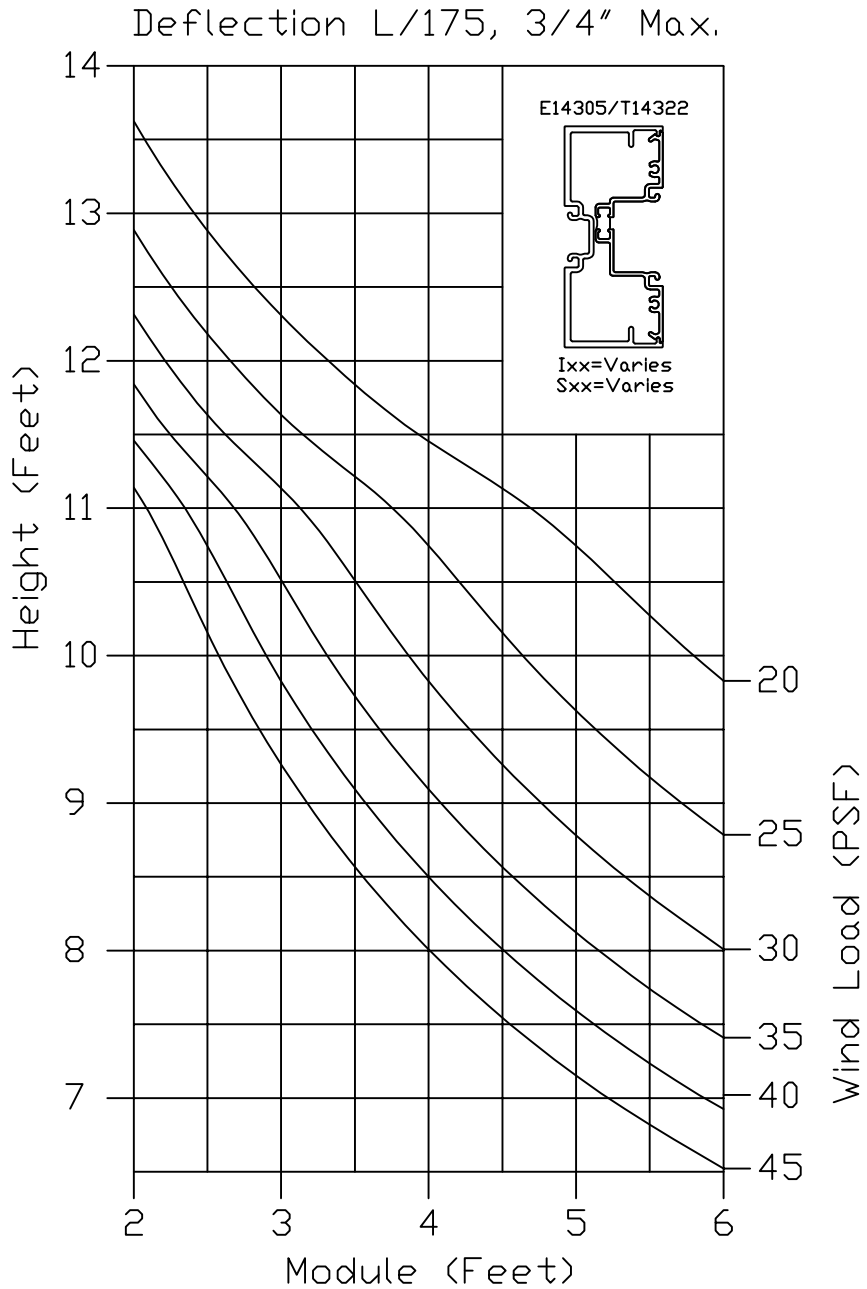

T14000 I/O Storefront

E14305 T14332 Wind Load Chart

CAD DETAIL FILE NO.
E14305 T14332 WLC

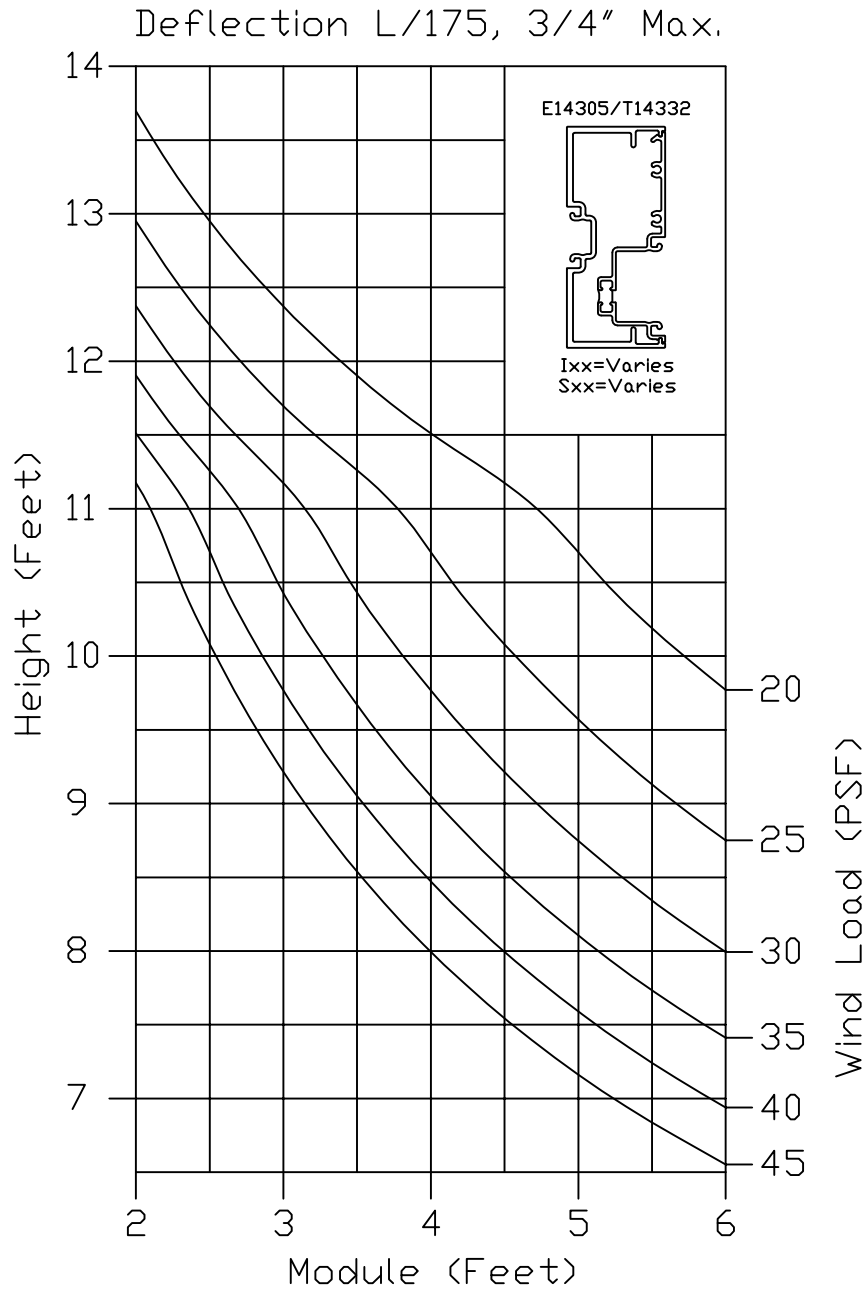

T14000 I/O Storefront

T14311 and T14312 Wind Load Chart

CAD DETAIL FILE NO.
T14311 T14312 WLC

Deflection $L/175$, 3/4" Max.

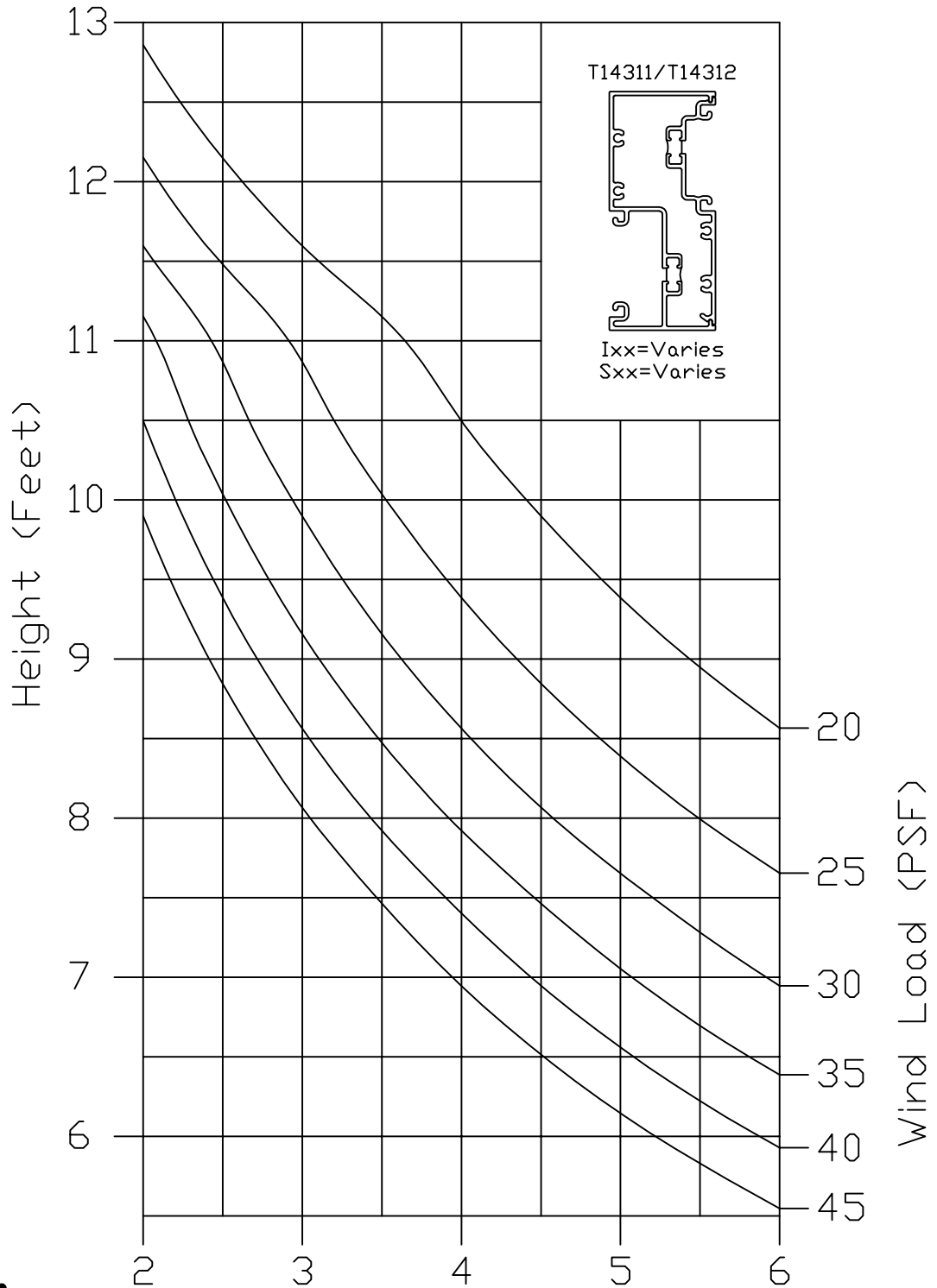

T14000 I/O Storefront

T14356 and E14302 Wind Load Chart

CAD DETAIL FILE NO.
T14356 E14302 WLC

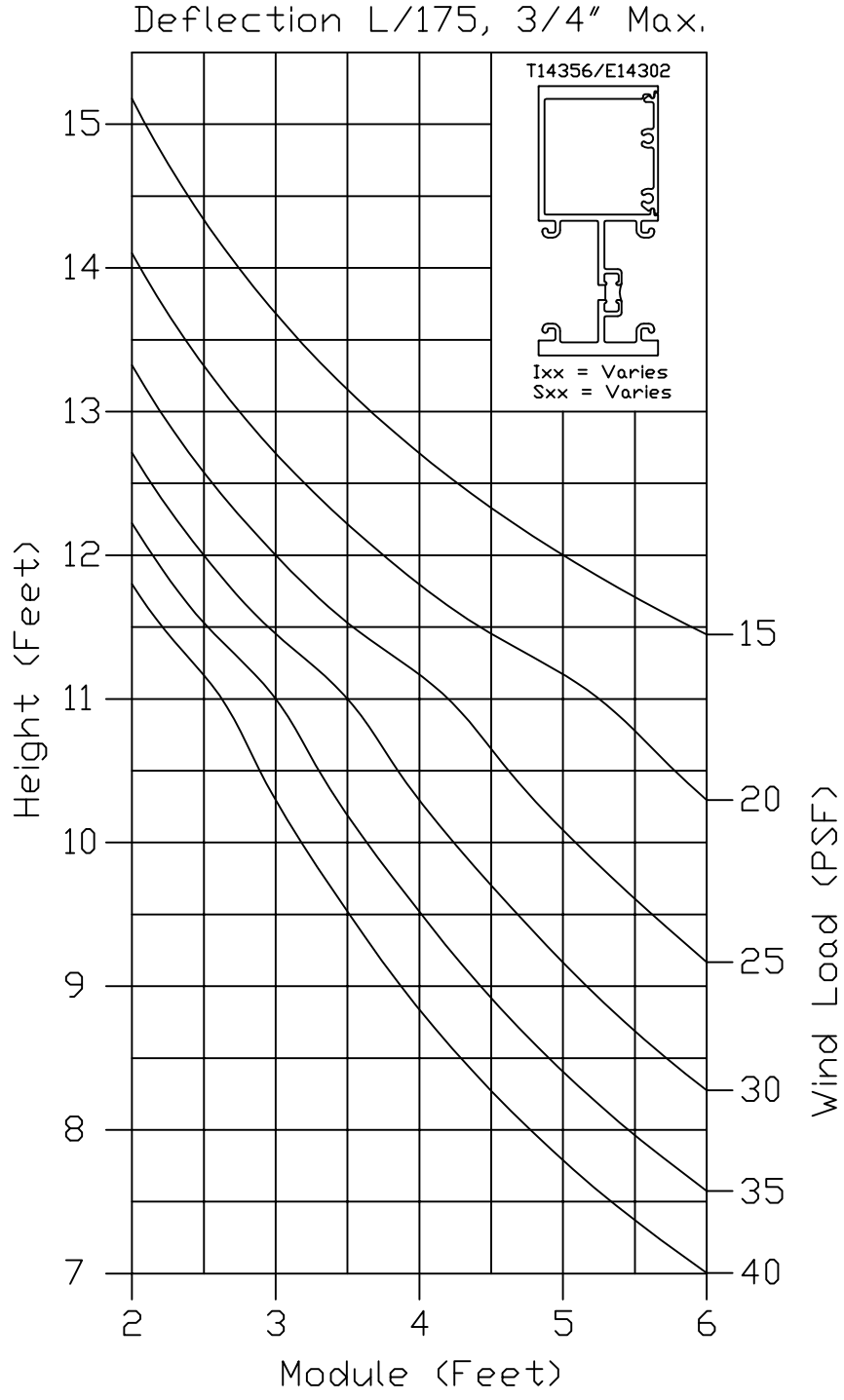

T14000 I/O Storefront

T14336 and T14346 Wind Load Chart

CAD DETAIL FILE NO.
T14336 T14346 WLC

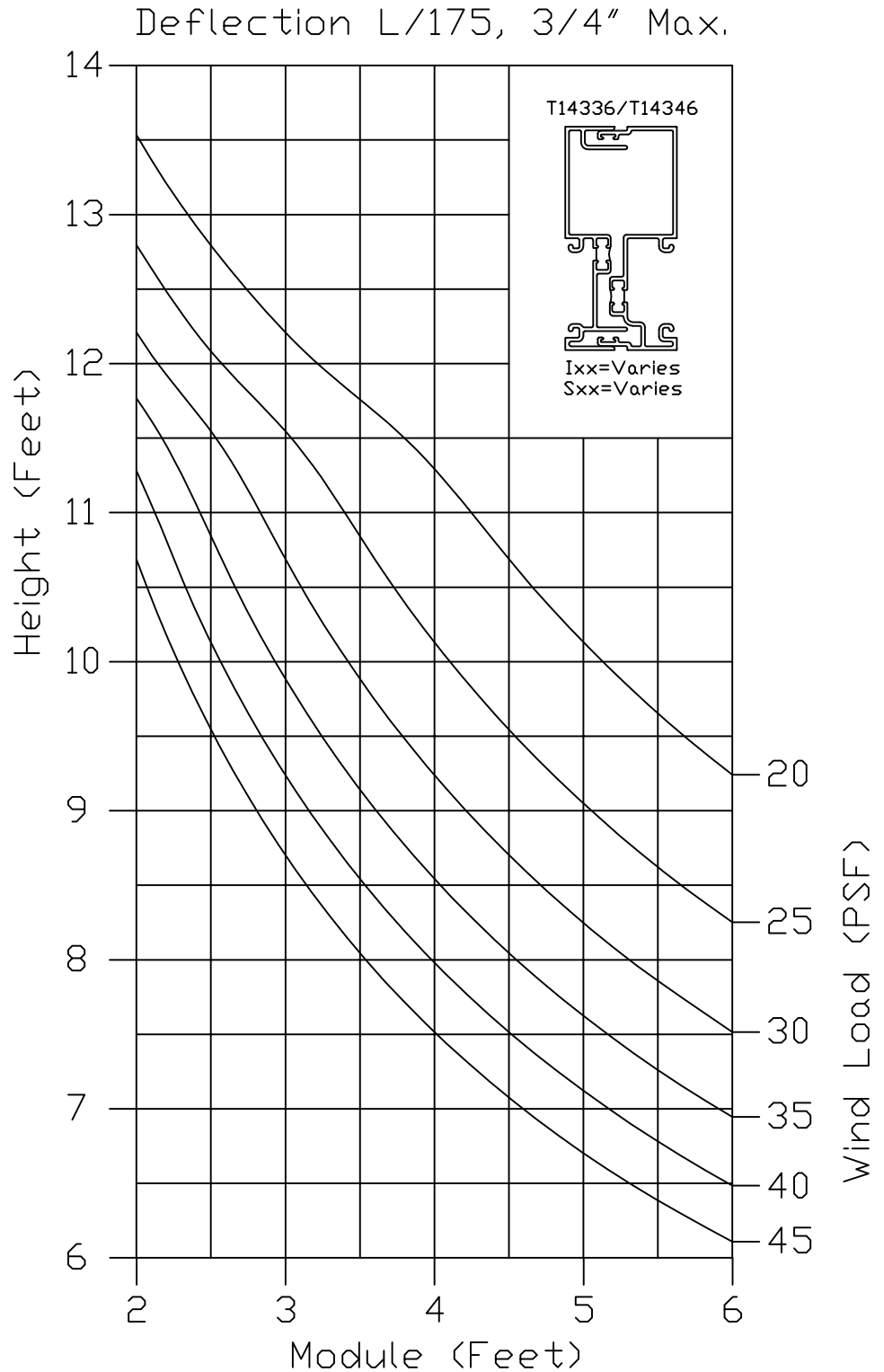

T14000 I/O Storefront

T14301 Wind Load Chart

CAD DETAIL FILE NO.
T14301 WLC

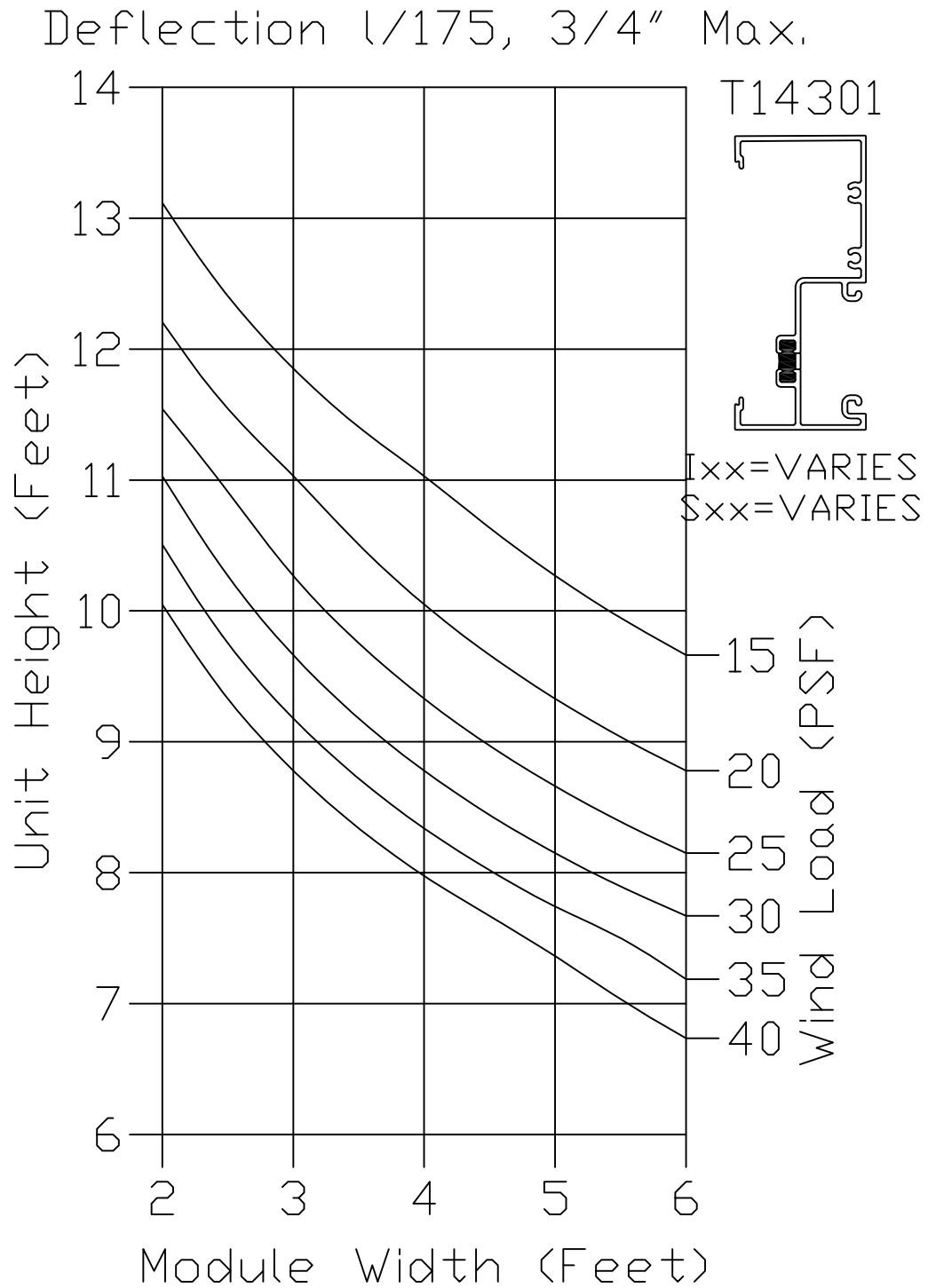

T14000 I/O Storefront

E14305 Wind Load Chart

CAD DETAIL FILE NO.
E14305 WLC

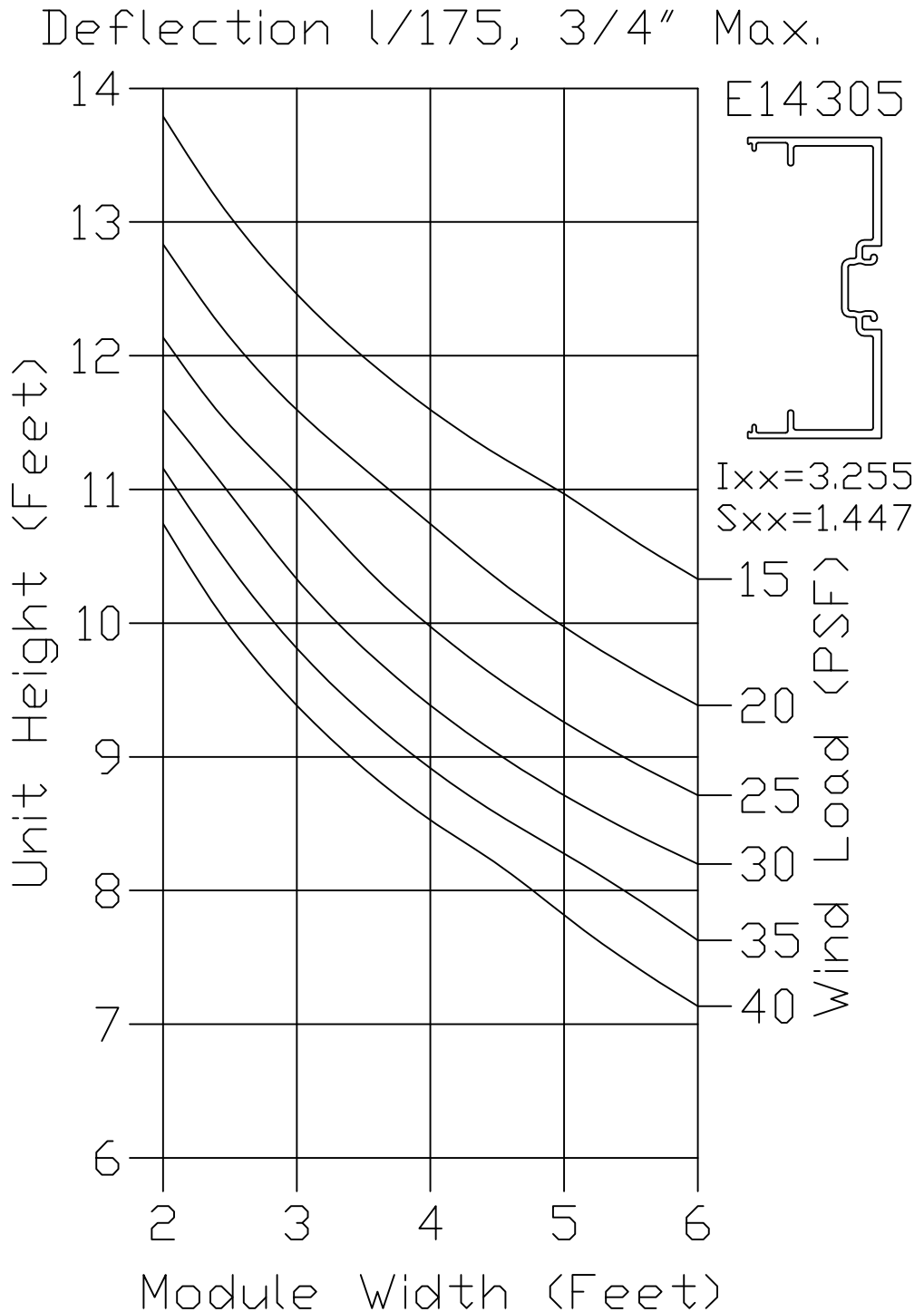

T14000 I/O Storefront

T14306 Wind Load Chart

CAD DETAIL FILE NO.
T14306 WLC

Deflection 1/175, 3/4" Max.

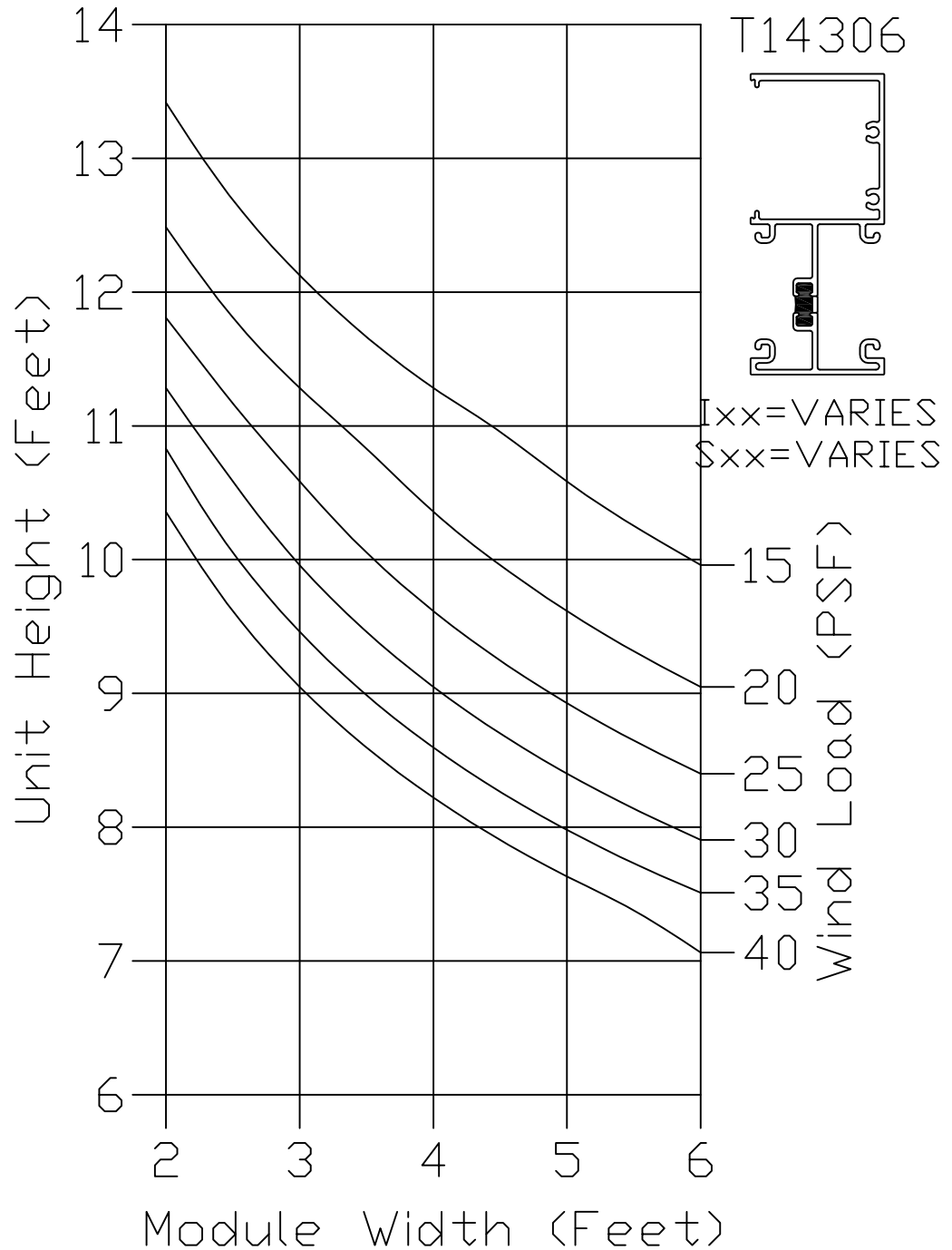

T14000 I/O Storefront

T14311 Wind Load Chart

CAD DETAIL FILE NO.
T14311 WLC

