

200 Series Curtainwall

E0977 Windload Chart

CAD DETAIL FILE NO.
E0977 WLC

Deflection L/175, 3/4" Max.

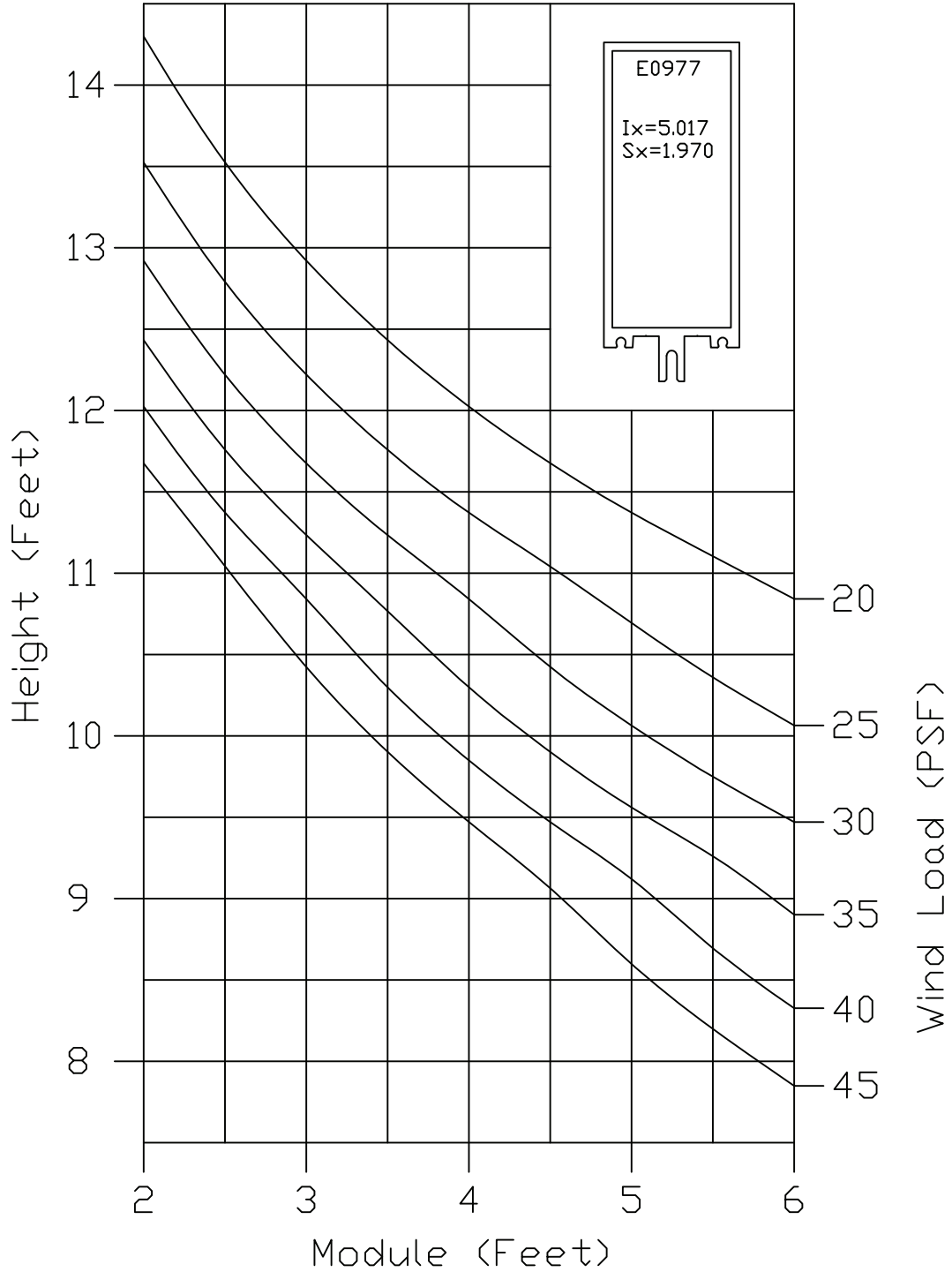

200 Series Curtainwall

E1025 Wind Load Chart

CAD DETAIL FILE NO.
E1025 WLC

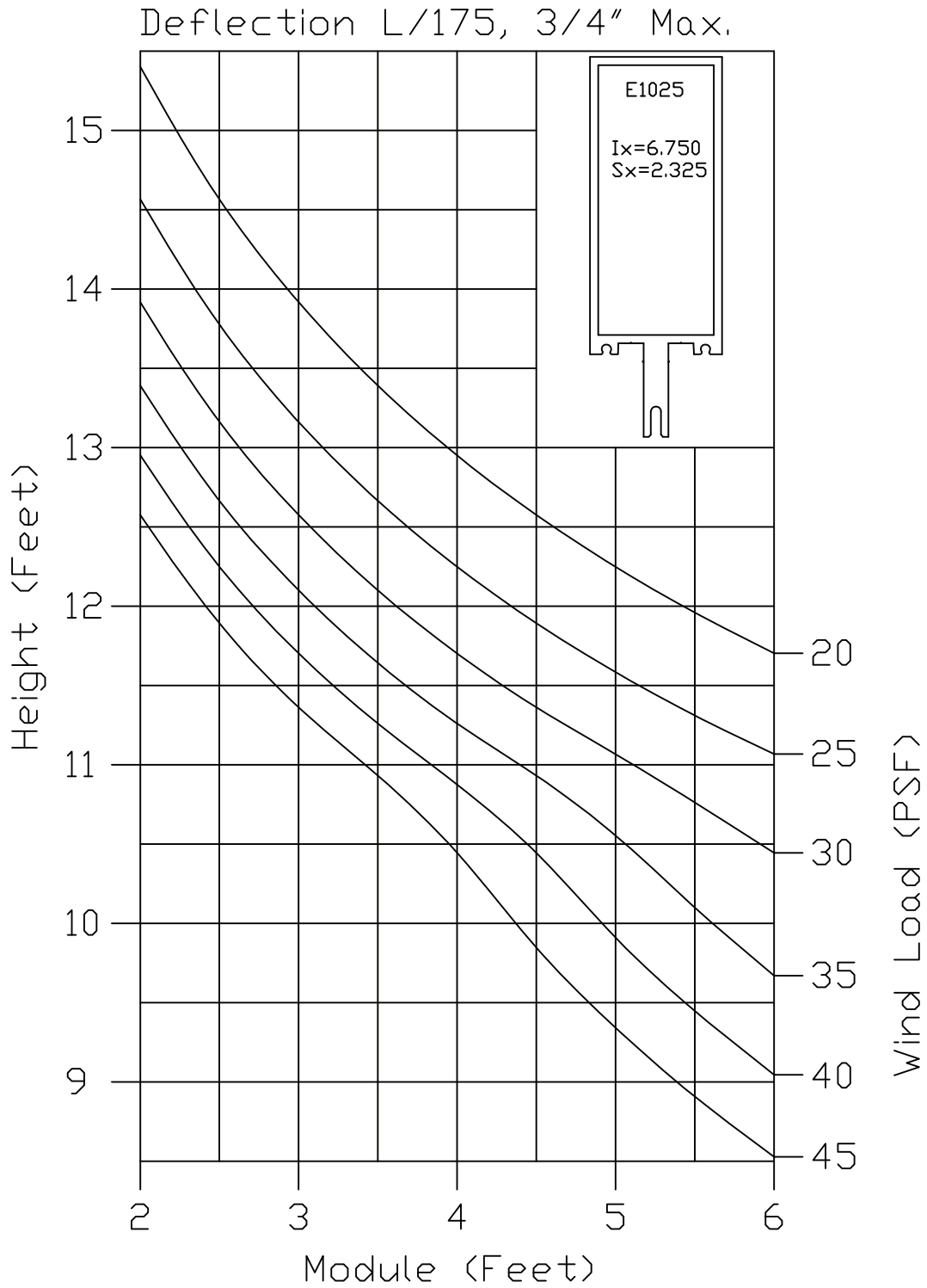

200 Series Curtainwall

E1046 Wind Load Chart

CAD DETAIL FILE NO.
E1046 WLC

Deflection L/175, 3/4" Max.

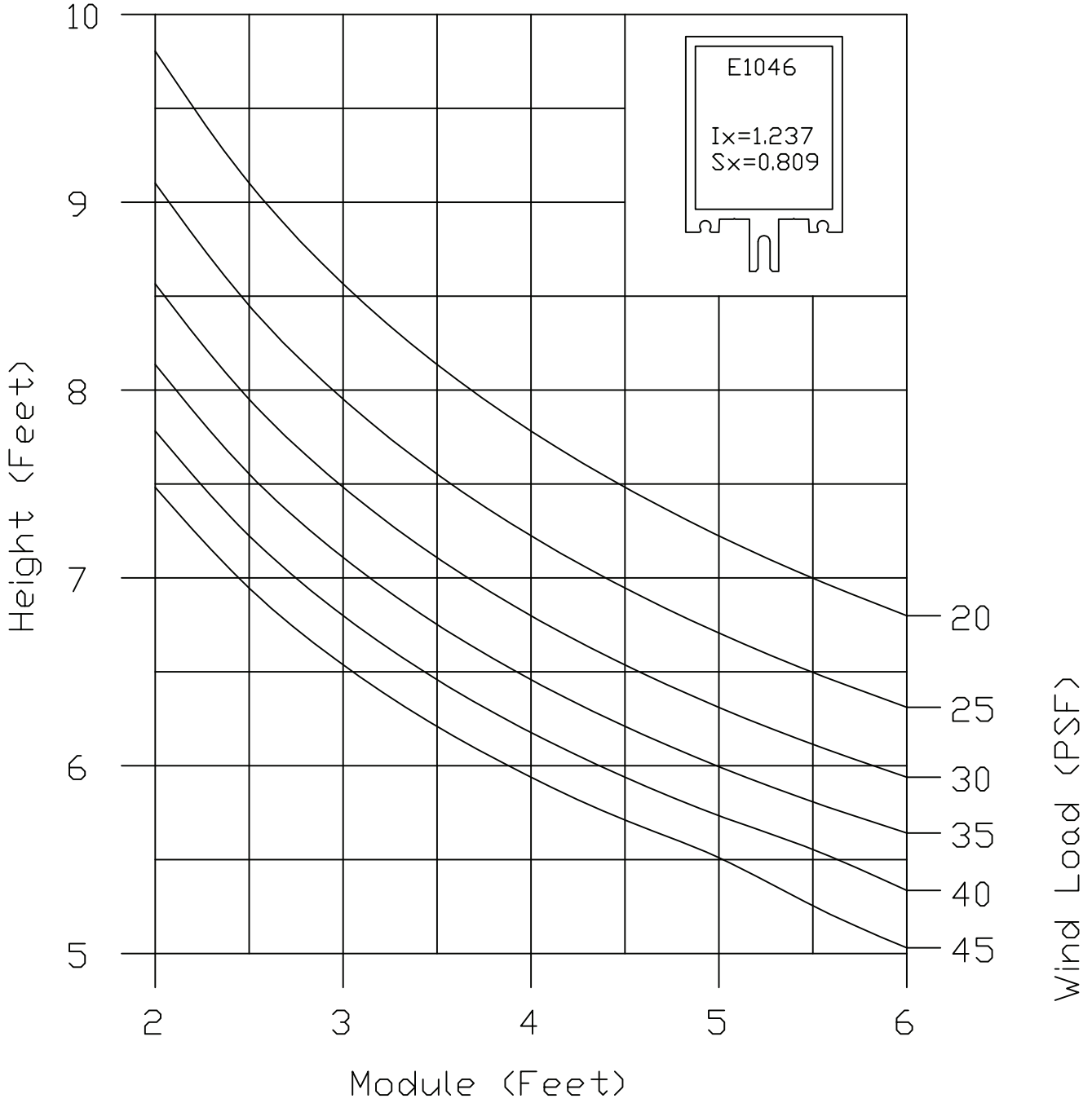

*SEALANT, ROD, & ANCHORS NOT BY WAUSAU

200 Series Curtainwall

E1148 Wind Load Chart

CAD DETAIL FILE NO.
E1148 WLC

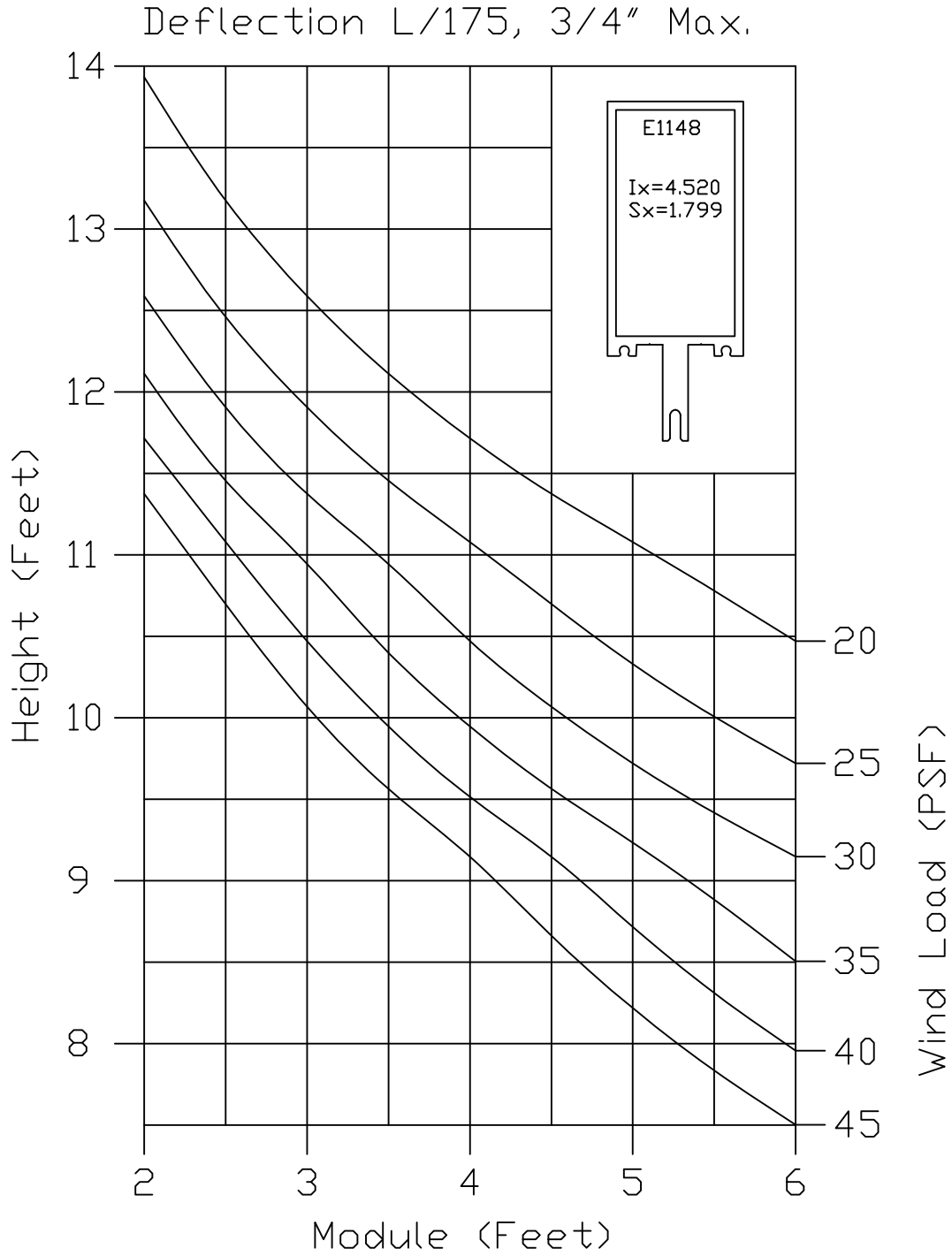

200 Series Curtainwall

E1180 Wind Load Chart

CAD DETAIL FILE NO.
E1180 WLC

Deflection $L/175$, $3/4"$ Max.

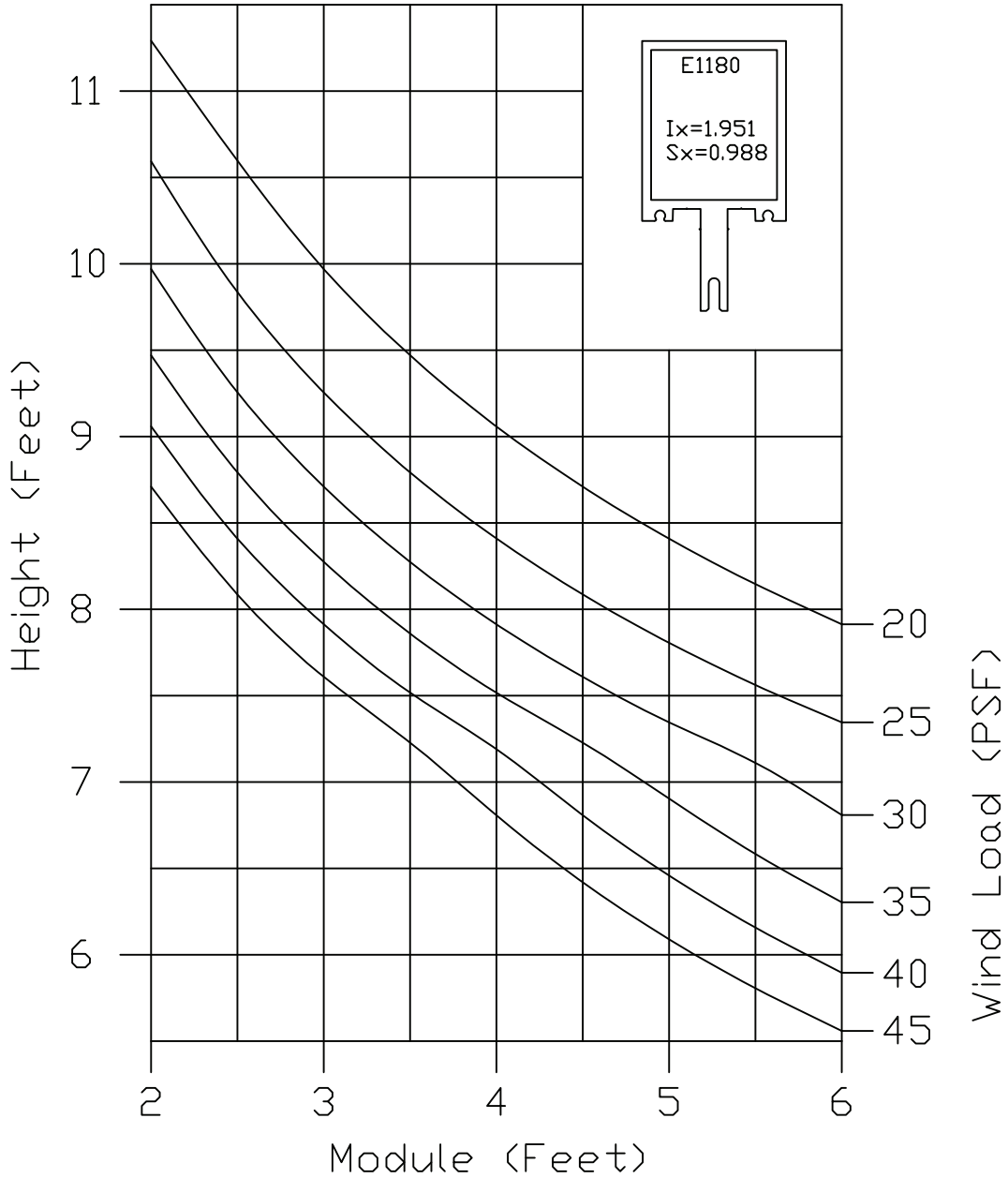

200 Series Curtainwall

E1199 Wind Load Chart

CAD DETAIL FILE NO.
XXXXXXX

Deflection L/175, 3/4" Max.

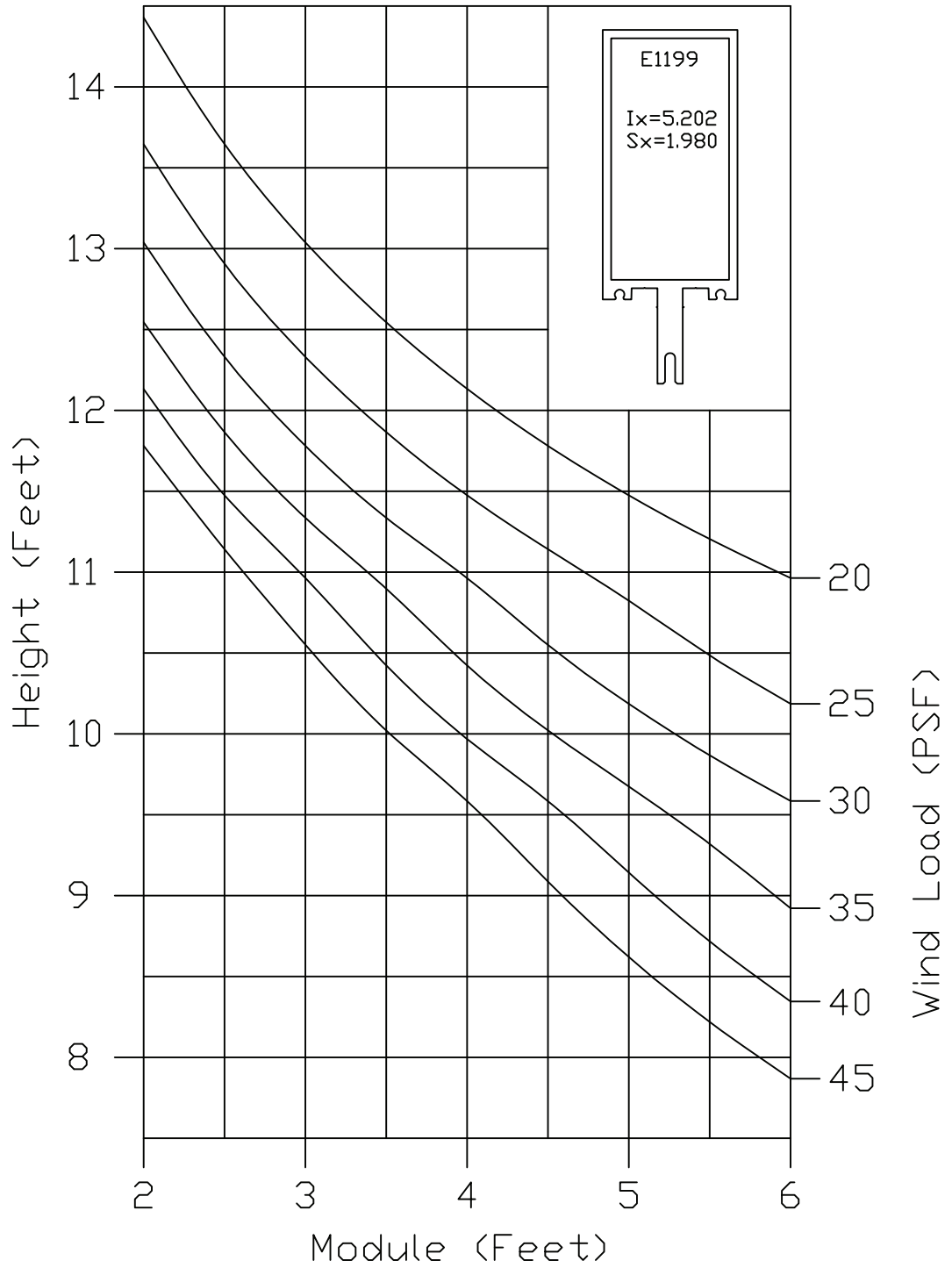

200 Series Curtainwall

E1215 Wind Load Chart

CAD DETAIL FILE NO.
E1215 WLC

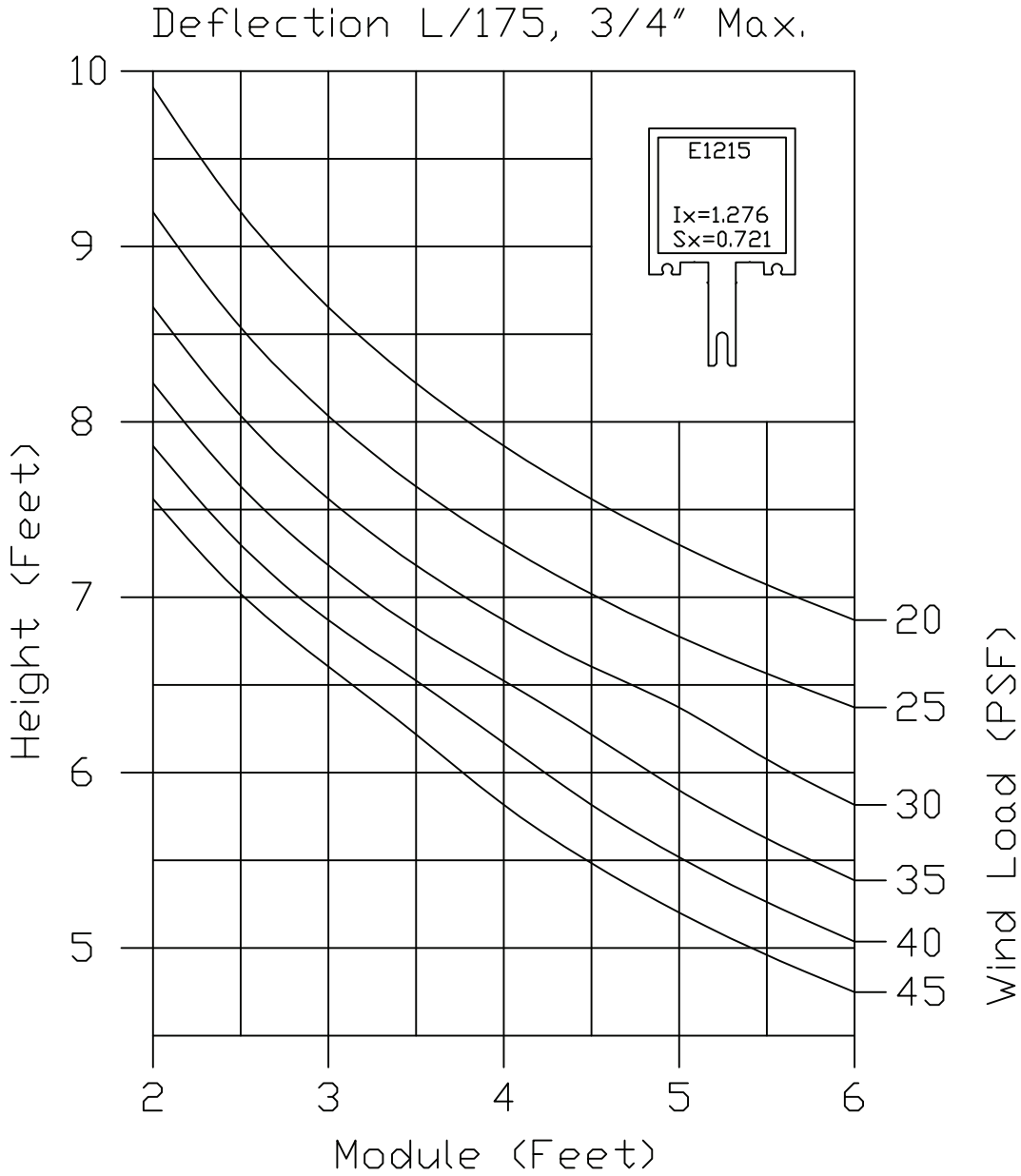

200 Series Curtainwall

E1495 Wind Load Chart

CAD DETAIL FILE NO.
E1495 WLC

Deflection L/175, 3/4" Max.

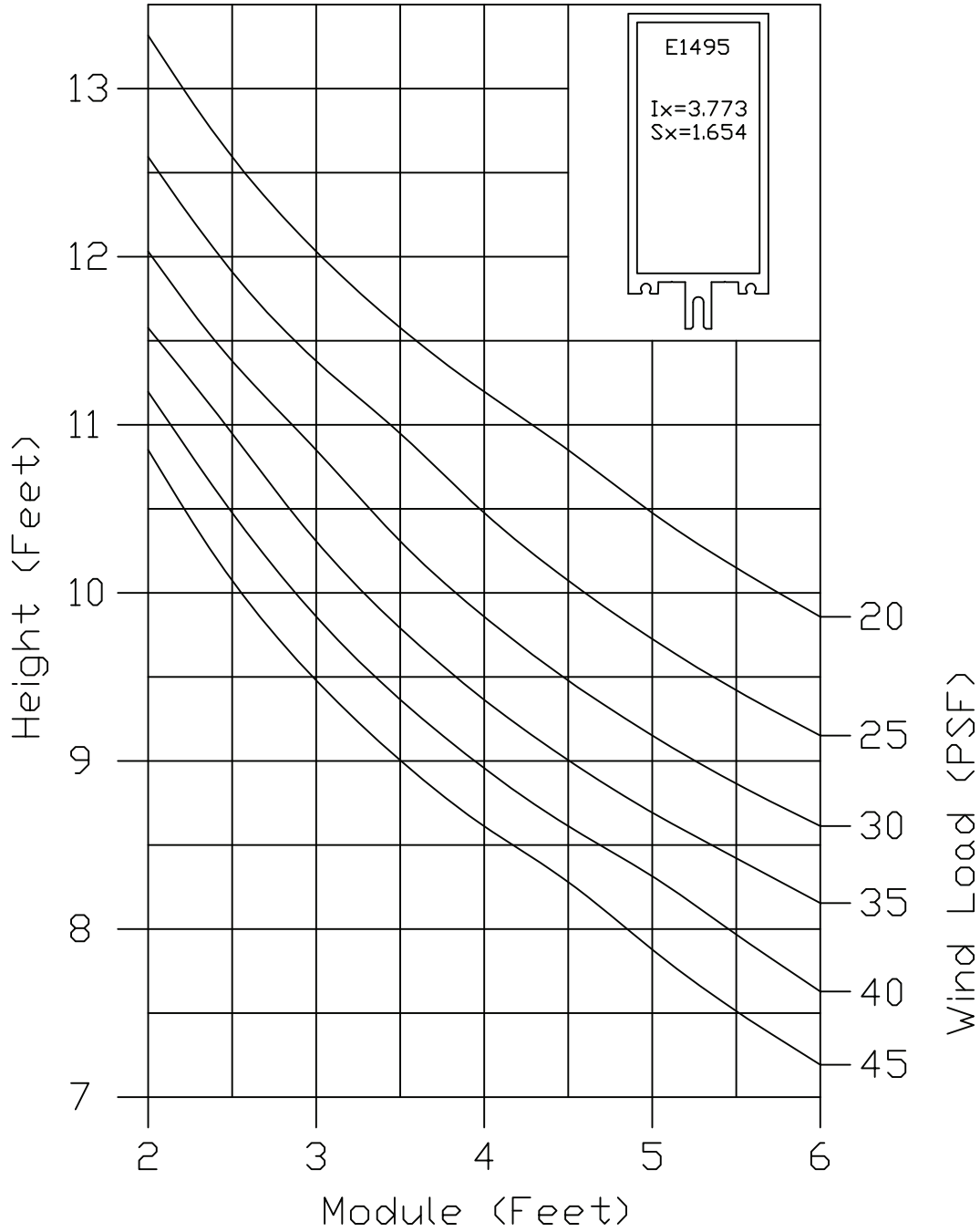

200 Series Curtainwall

E1584 Wind Load Chart Deflection L/175, 3/4" Max.

CAD DETAIL FILE NO.
E1584 WLC

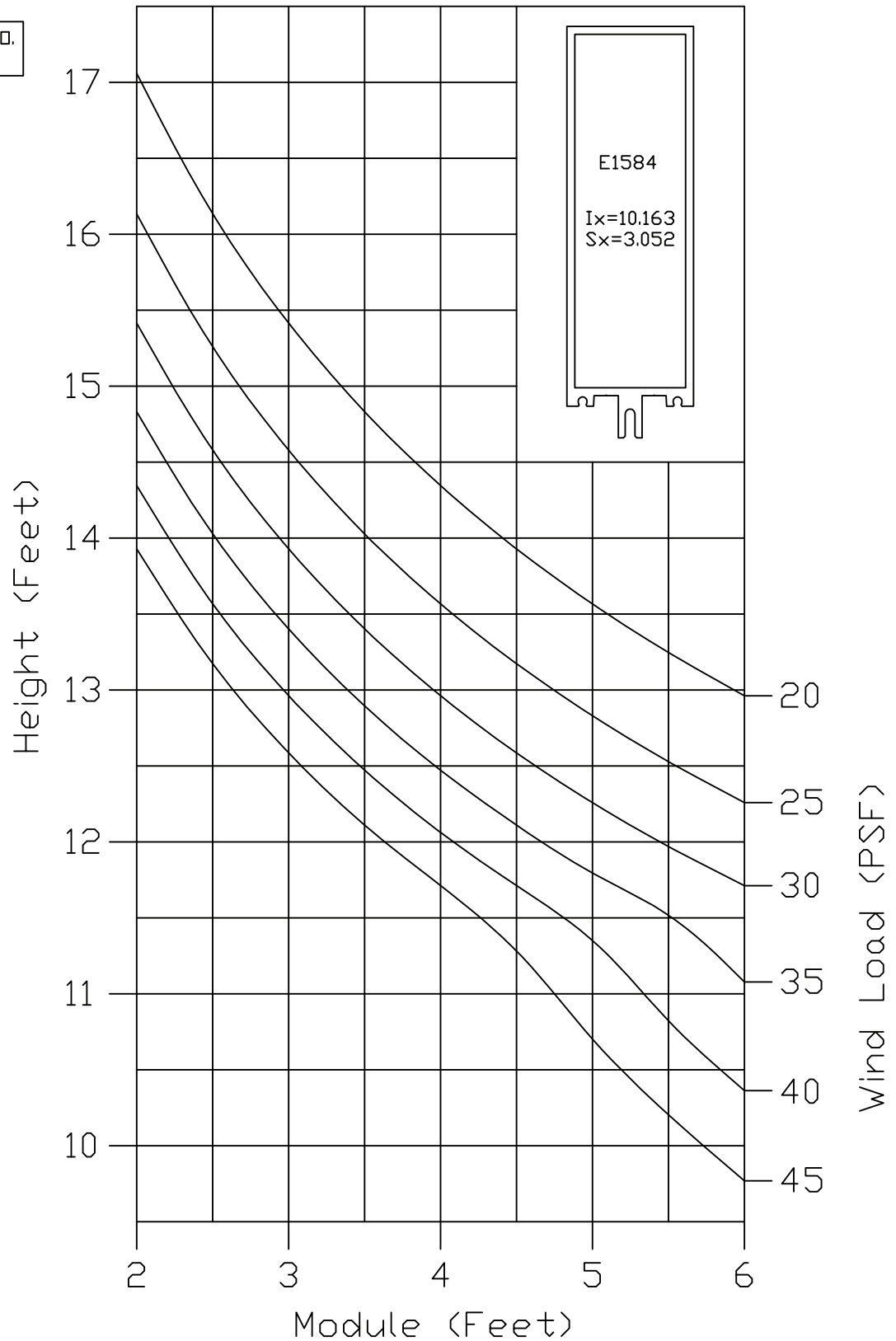

200 Series Curtainwall

E2053 Wind Load Chart

CAD DETAIL FILE NO.
E2053 WLC

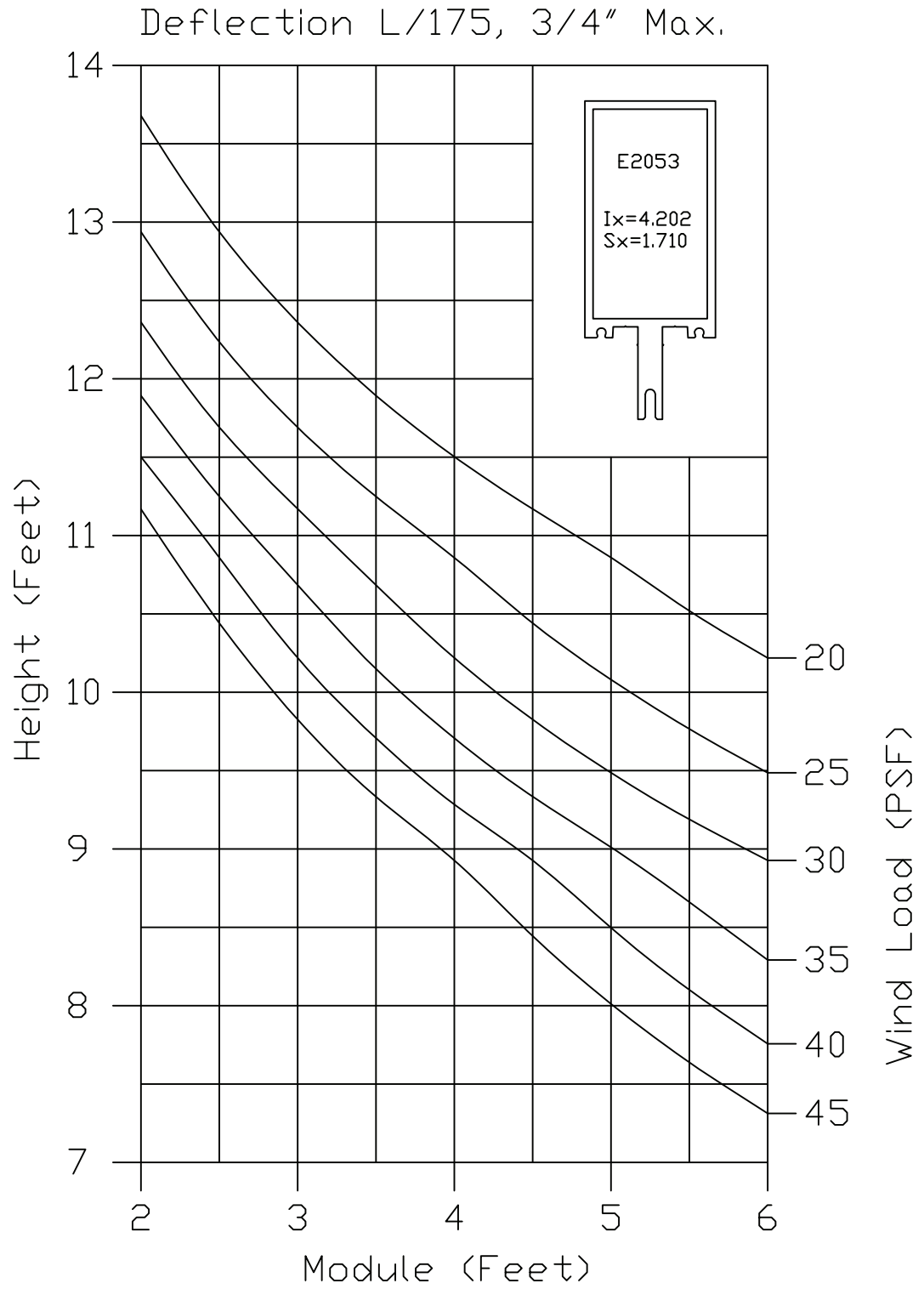

200 Series Curtainwall Deflection L/175, 3/4" Max. E2297 Wind Load Chart

CAD DETAIL FILE NO.
E2297 WLC

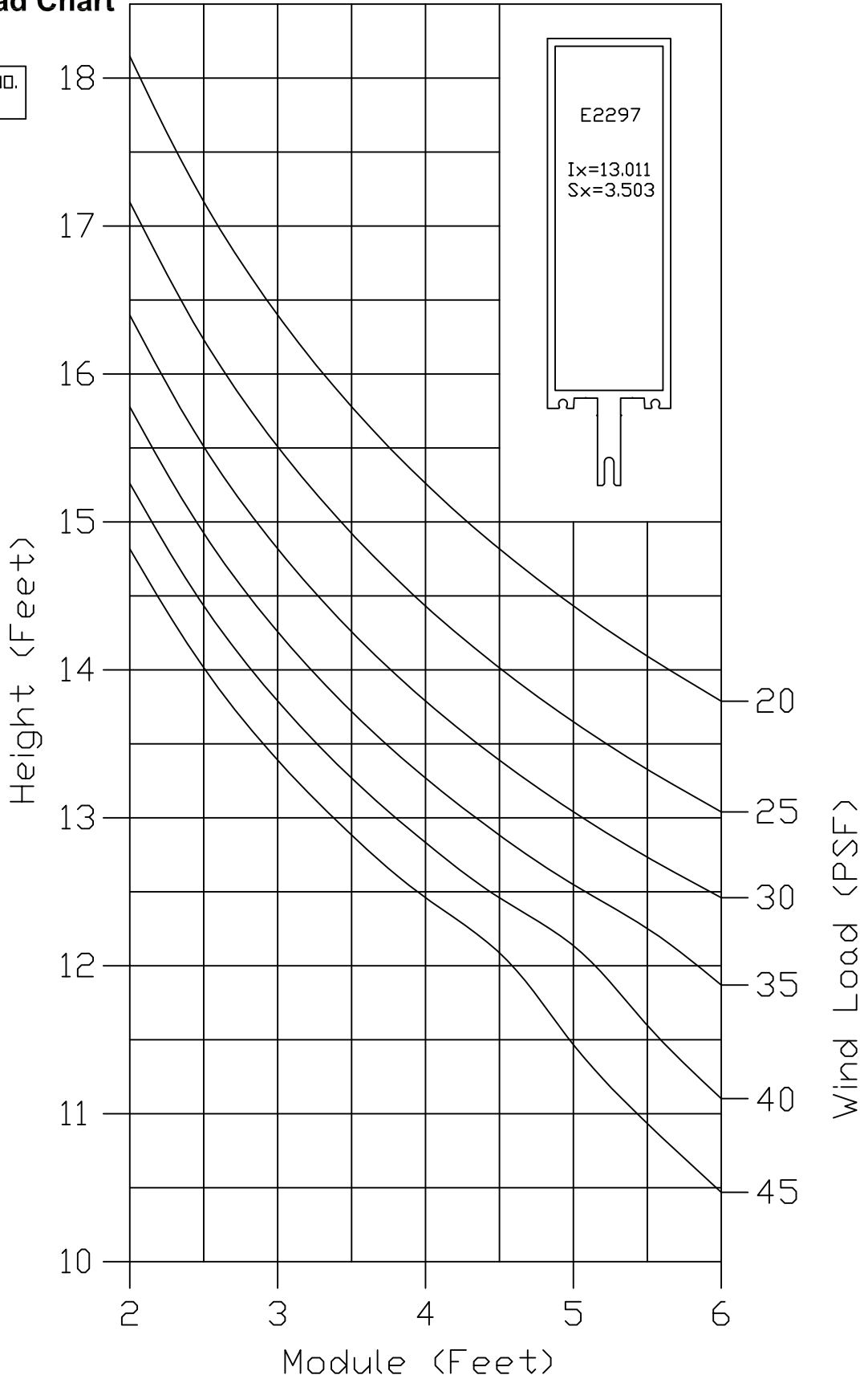

*SEALANT, ROD, & ANCHORS NOT BY WAUSAU

200 Series Curtainwall

E3125 Wind Load Chart

CAD DETAIL FILE NO.
E3125 WLC

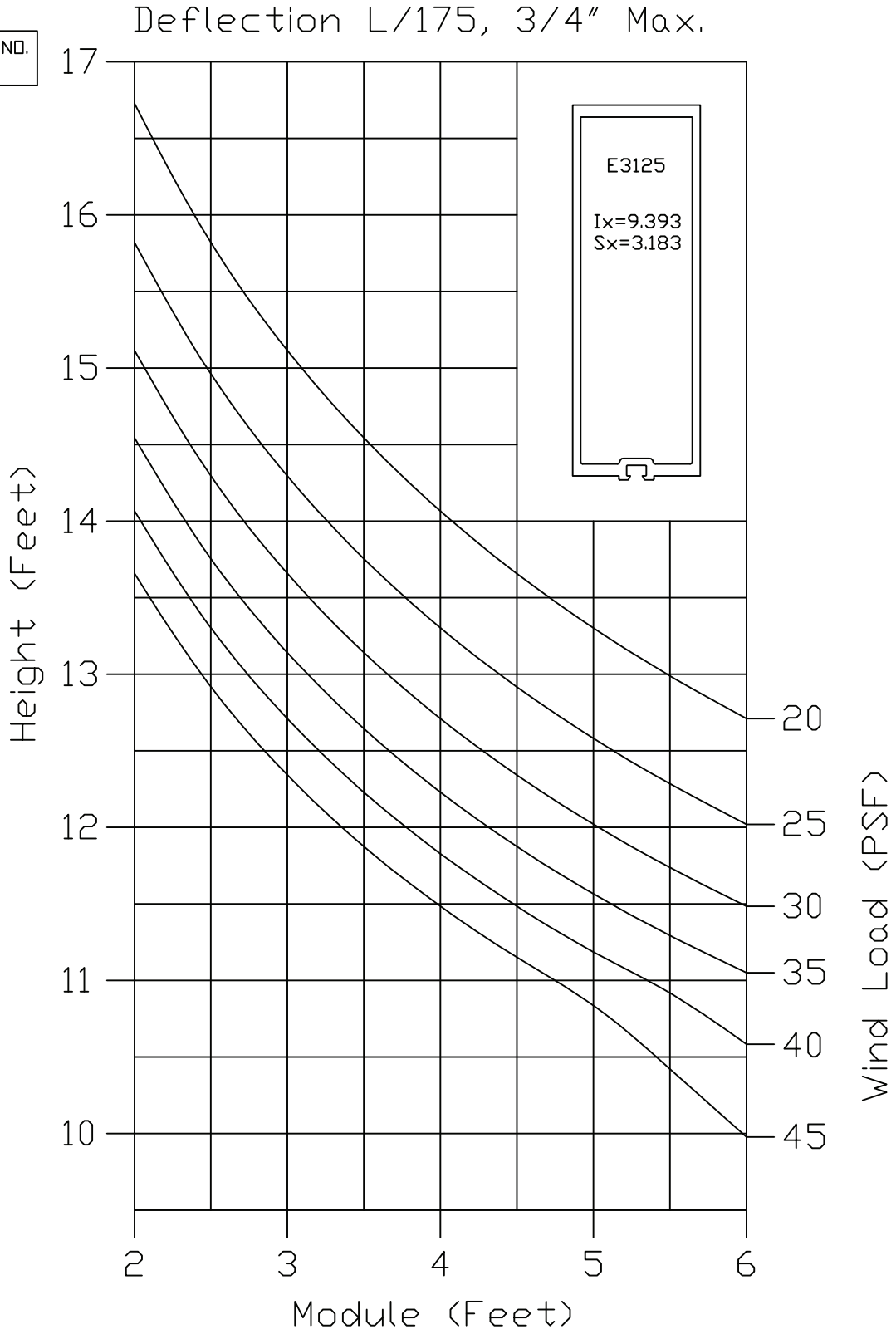

*SEALANT, ROD, & ANCHORS NOT BY WAUSAU

200 Series Curtainwall

E3126 Wind Load Chart

CAD DETAIL FILE NO.
E3126 WLC

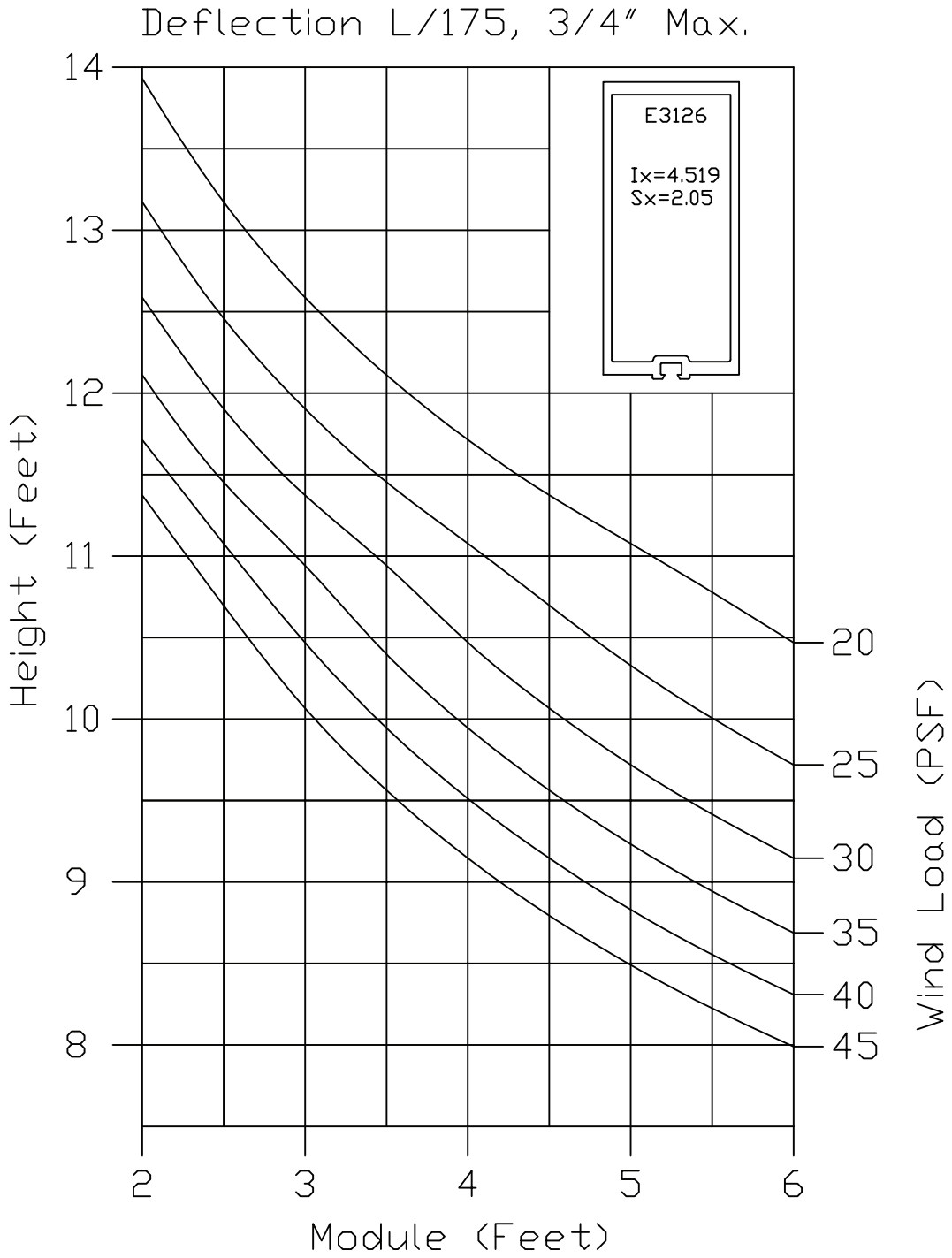

200 Series Curtainwall

E3127 Wind Load Chart

CAD DETAIL FILE NO.
E3127 WLC

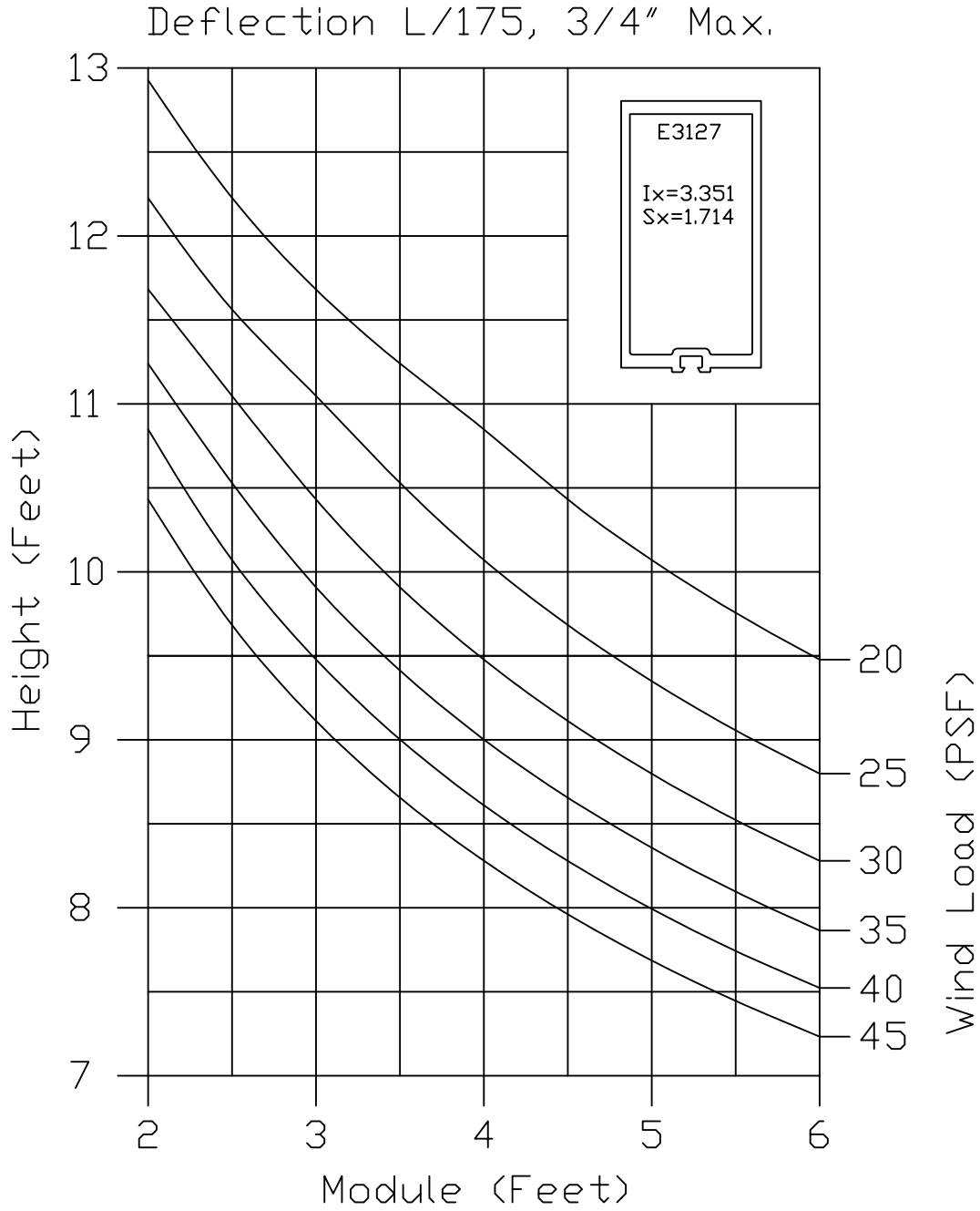

200 Series Curtainwall

E3130 Wind Load Chart

CAD DETAIL FILE NO.
E3130 WLC

Deflection $L/175$, $3/4"$ Max.

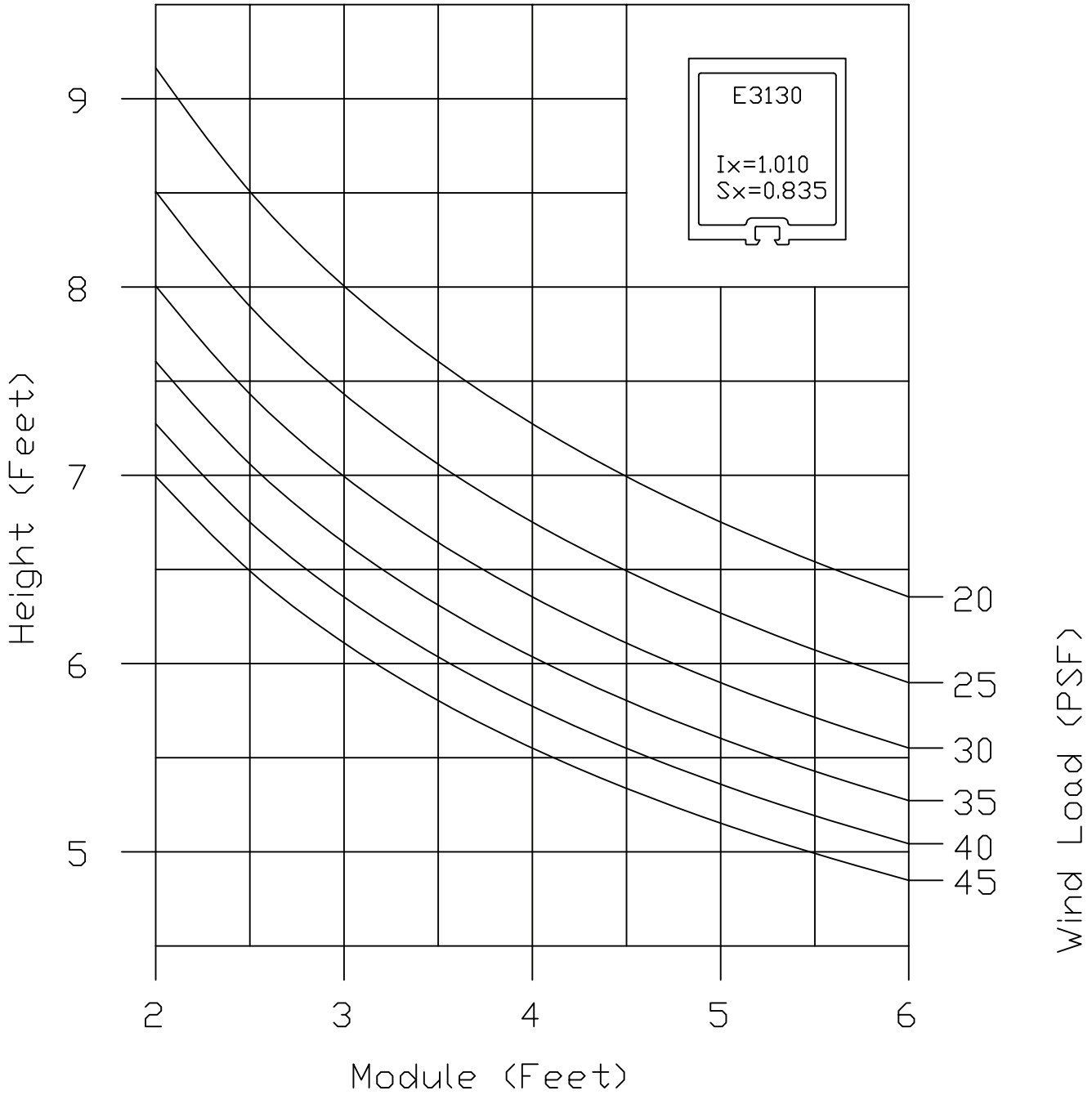

200 Series Curtainwall

E3154 Wind Load Chart

CAD DETAIL FILE NO.
E3154 WLC

Deflection L/175, 3/4" Max.

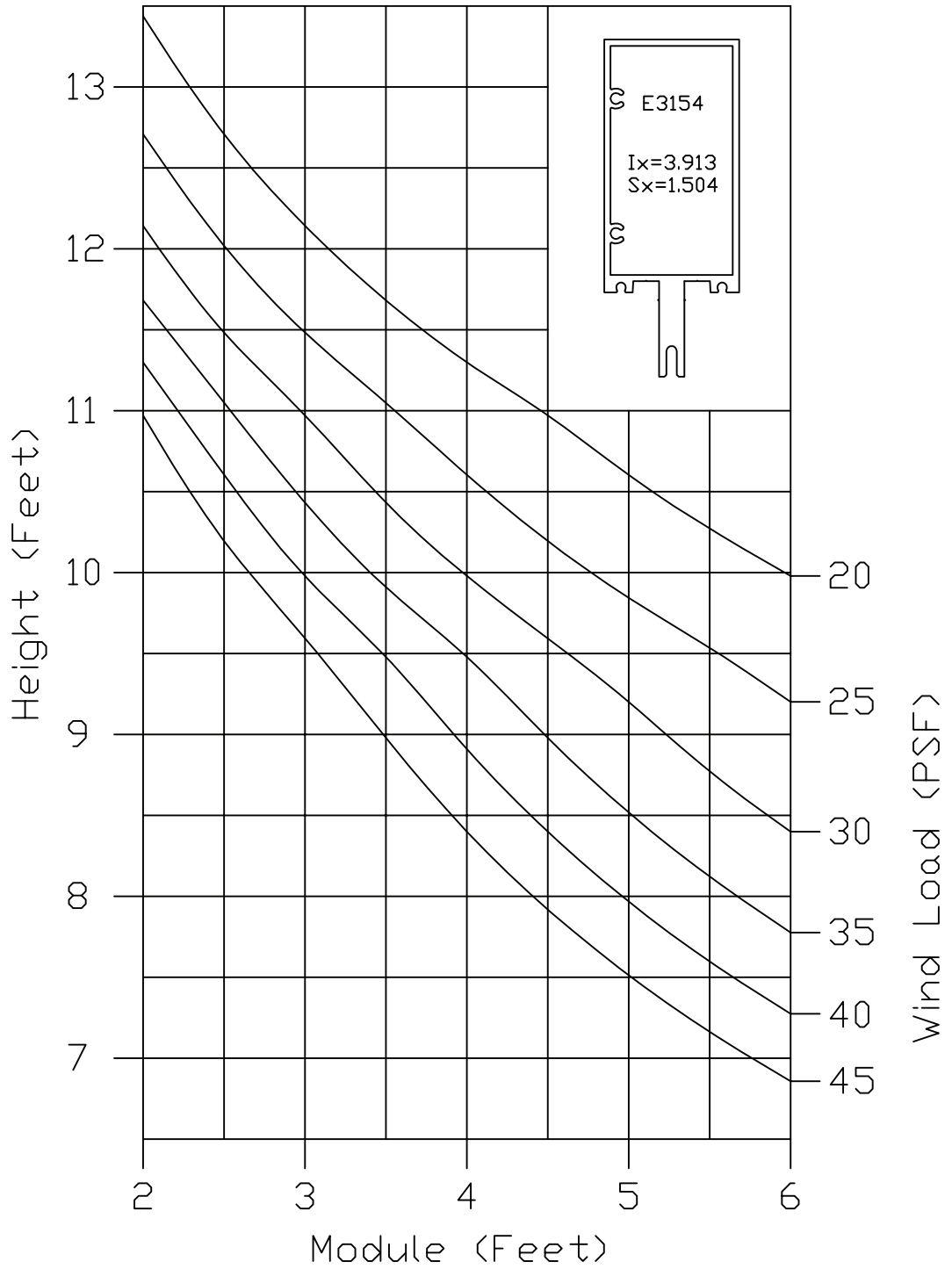

200 Series Curtainwall

E3202 Wind Load Chart

CAD DETAIL FILE NO.
E3202 WLC

Deflection L/175, 3/4" Max.

