

TYPICAL ELEVATION

400SS FIELD GLAZED CURTAIN WALL
 3-3/4" BACK MEMBER
 THERMAL PRESSURE PLATE

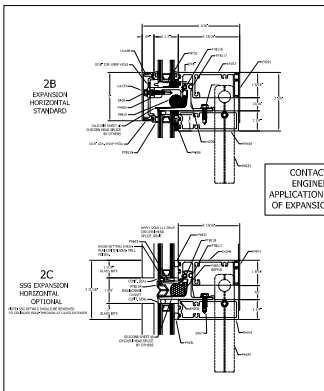

CONTACT TUBELITE
 ENGINEERING FOR
 APPLICATION & ENGINEERING
 OF EXPANSION HORIZONTAL

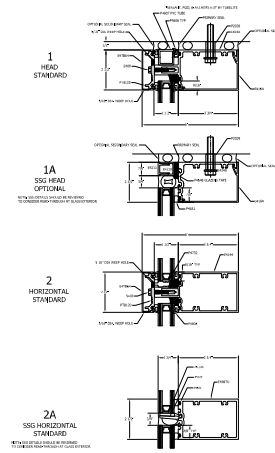
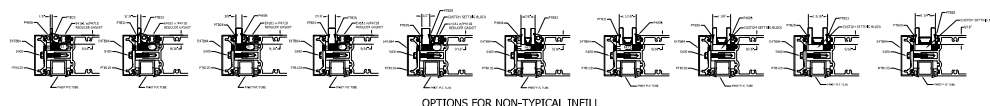
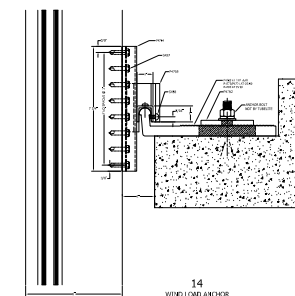
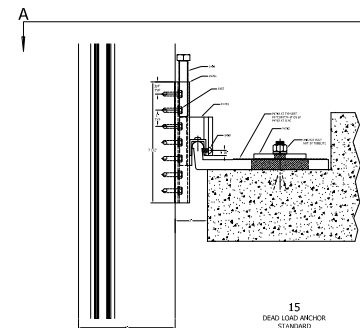
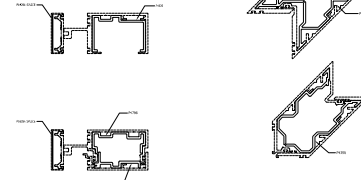
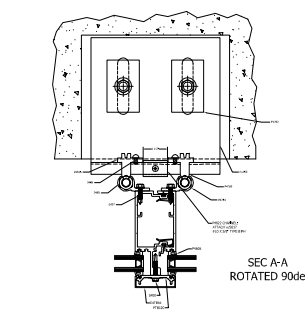
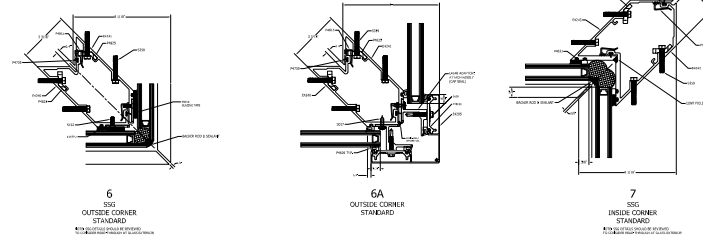
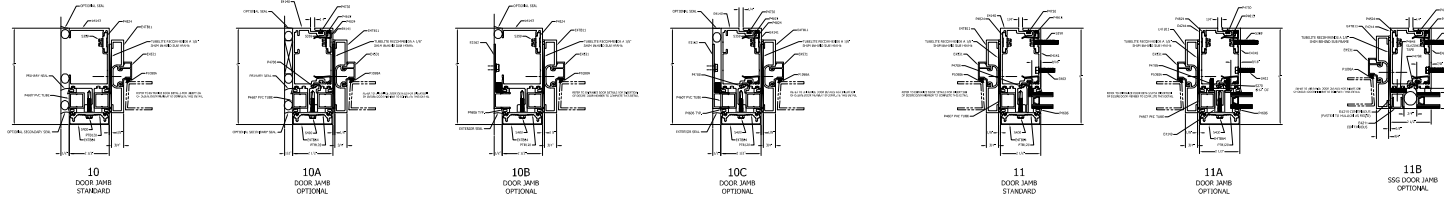
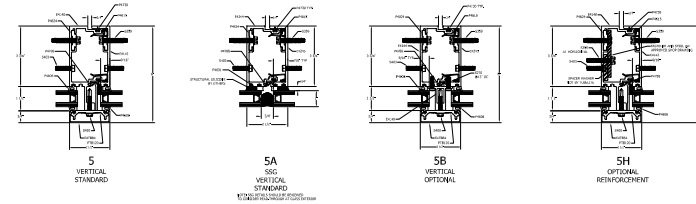
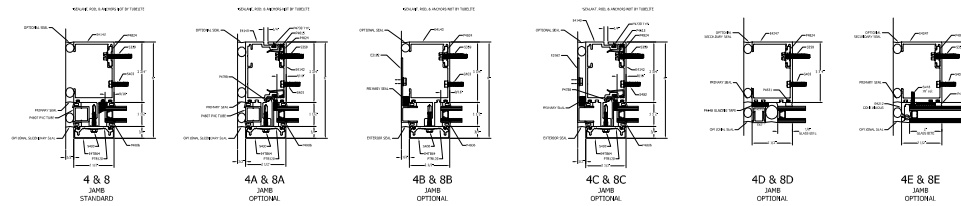
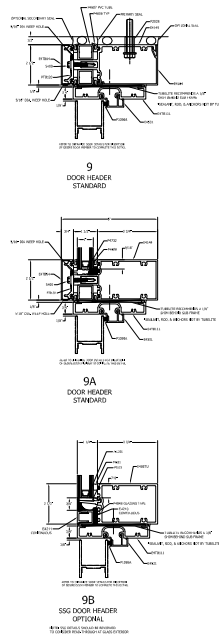
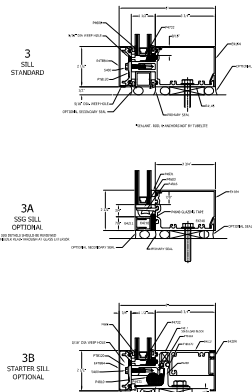

OPTIONS FOR NON-TYPICAL INFILL

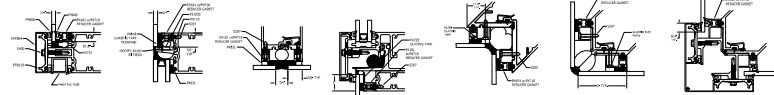

OPTIONS FOR 1/4" INFILL

GLAZING INFILL OPTIONS
 GLASS SHOWN DOES NOT NECESSARILY REPRESENT FINAL CONFIGURATION.
 CONSULT GLASS MANUFACTURER FOR SPECIFIC GLASS MAKE UP.

TUBELITE[®]
DEPENDABLE
 LEADERS IN ECO-EFFICIENT STOREFRONT,
 CURTAINWALL AND ENTRANCE SYSTEMS
 LAST REVISED: 7-09-2020