

# E14000 I/O Storefront

## E14302 and E14306 Wind Load Chart

CAD DETAIL FILE NO.  
E14302 E14306 WLC

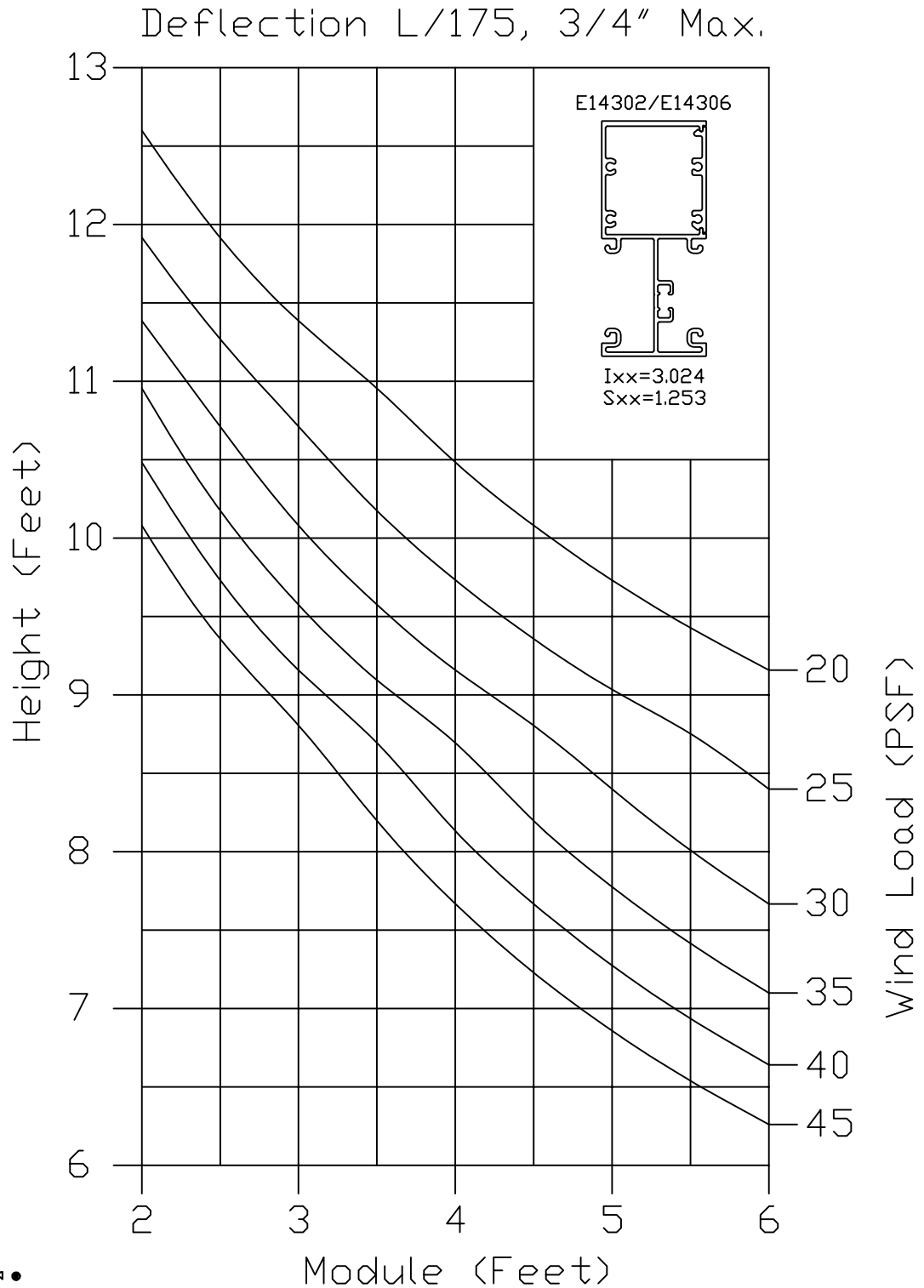

# E14000 I/O Storefront

## E14302 and E14356 Wind Load Chart

CAD DETAIL FILE NO.  
E14302 E14356 WLC

Deflection L/175, 3/4" Max.

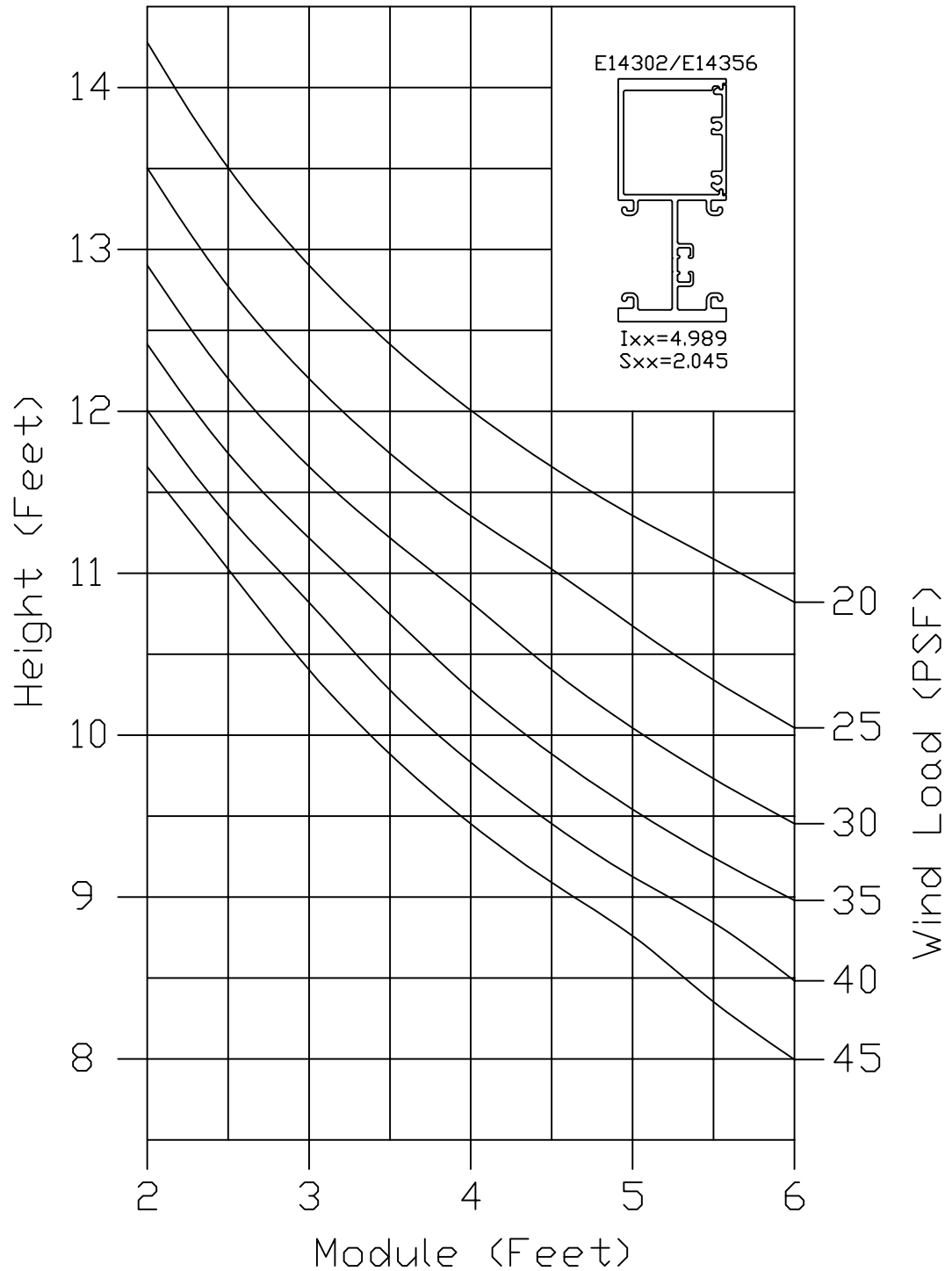

# E14000 I/O Storefront

## E14305 and E14312 Wind Load Chart

CAD DETAIL FILE NO.  
E14305 E14312 WLC

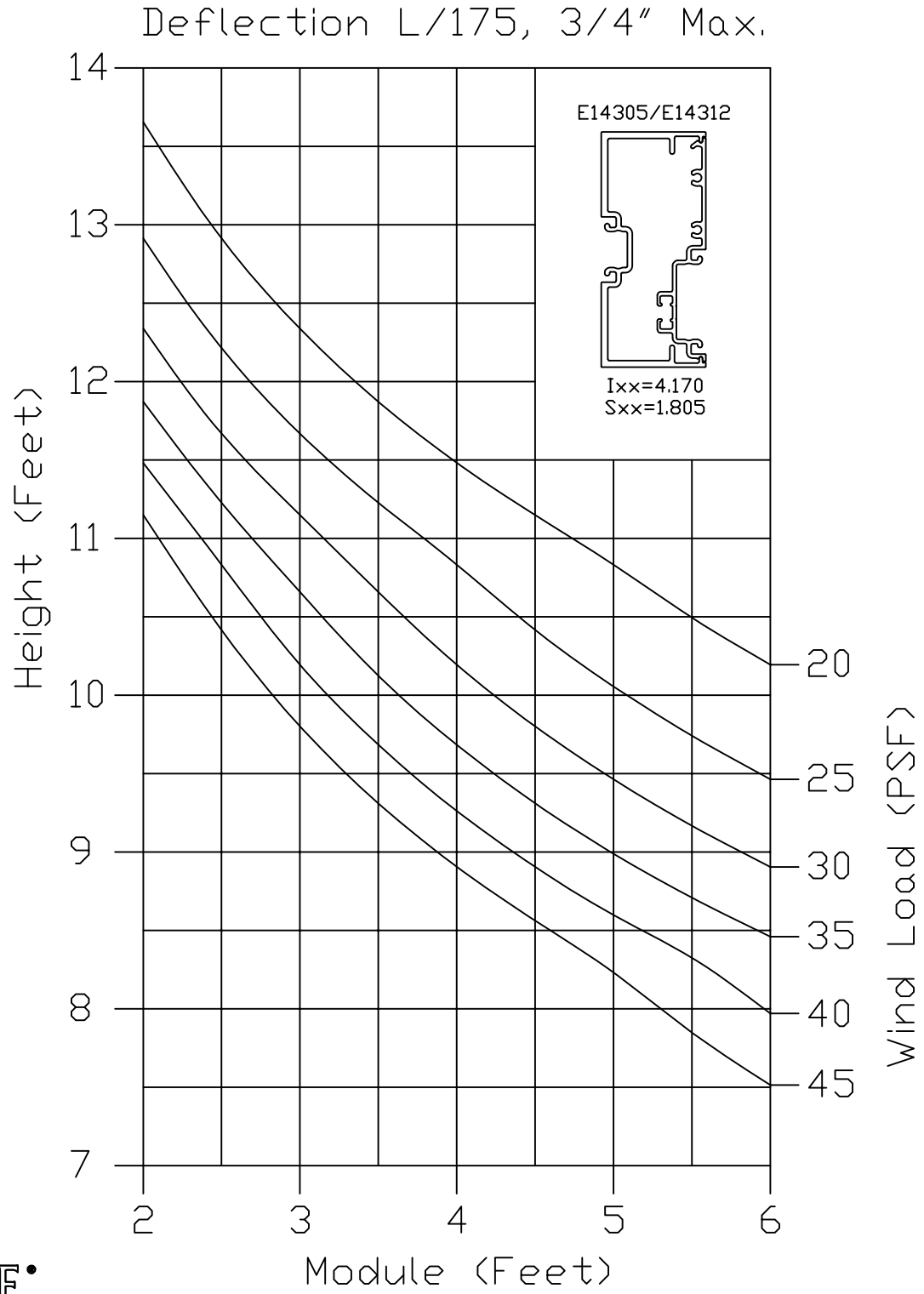

\*SEALANT, ROD, & ANCHORS NOT BY TUBELITE

# E14000 I/O Storefront

## E14305 and E14322 Wind Load Chart

CAD DETAIL FILE NO.  
E14305 E14322 WLC

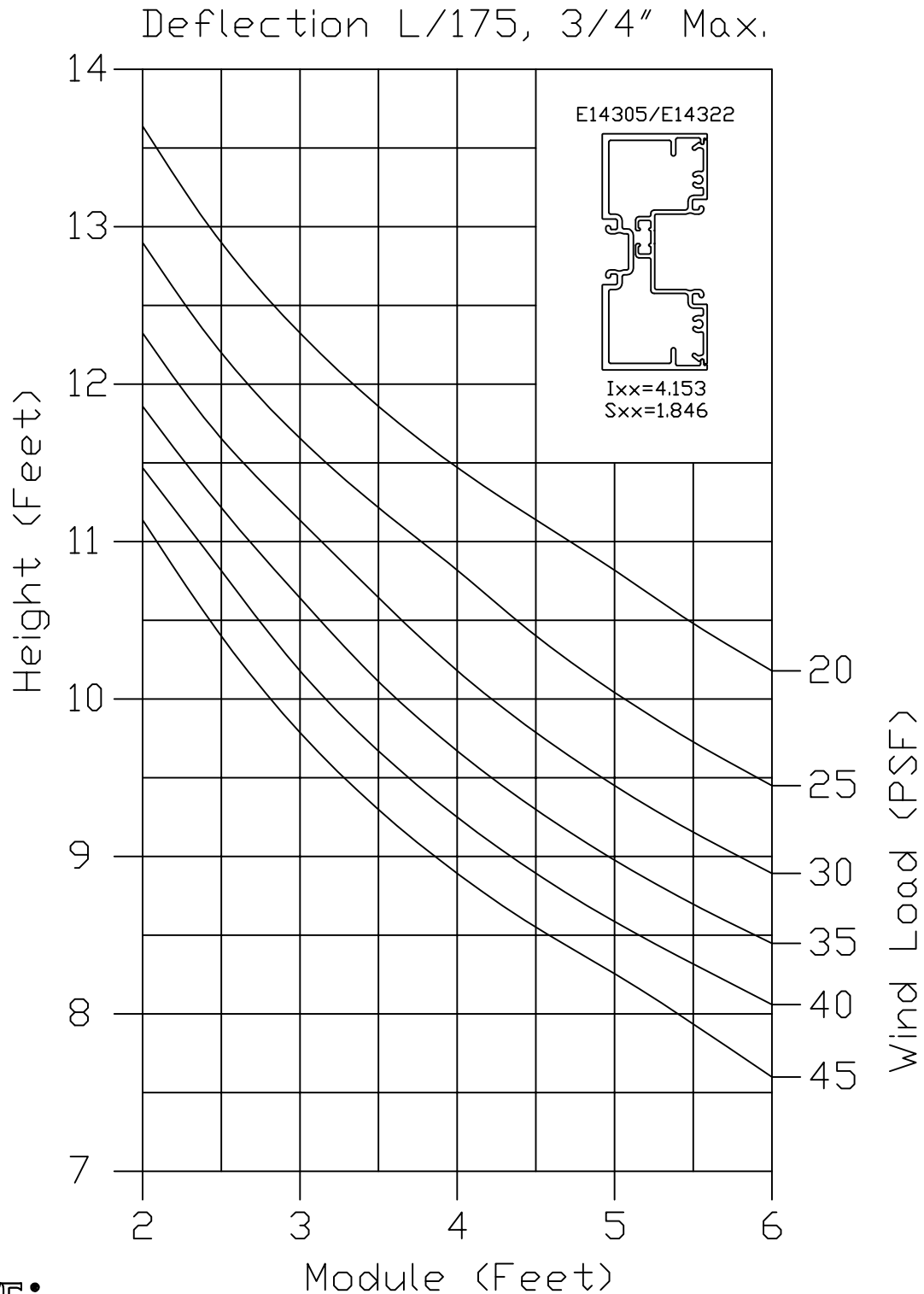

# E14000 I/O Storefront

## E14305 and E14332 Wind Load Chart

CAD DETAIL FILE NO.  
E14305 E14332 WLC

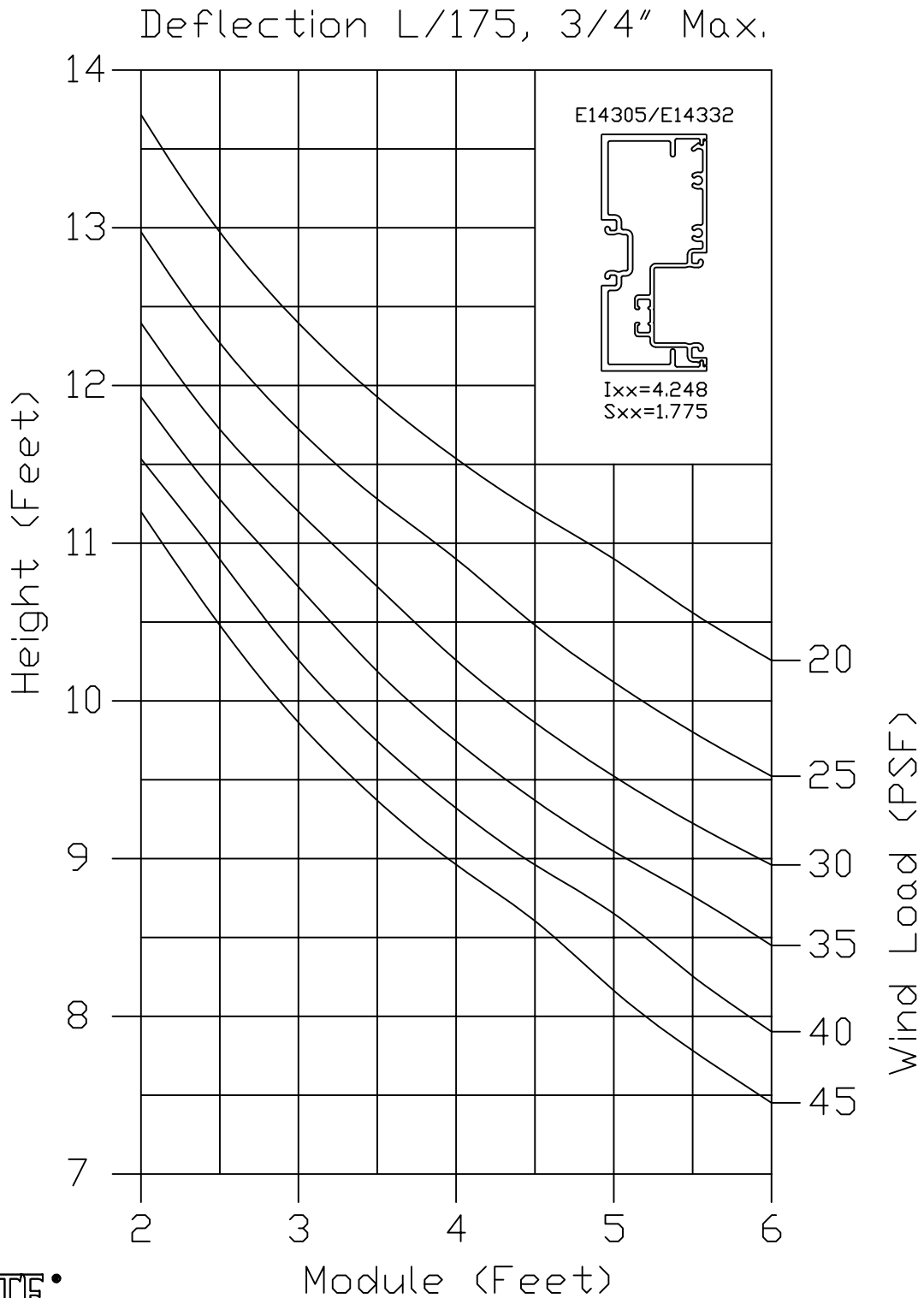

# E14000 I/O Storefront

## E14311 and E14312 Wind Load Chart

CAD DETAIL FILE NO.  
E14311 E14312 WLC

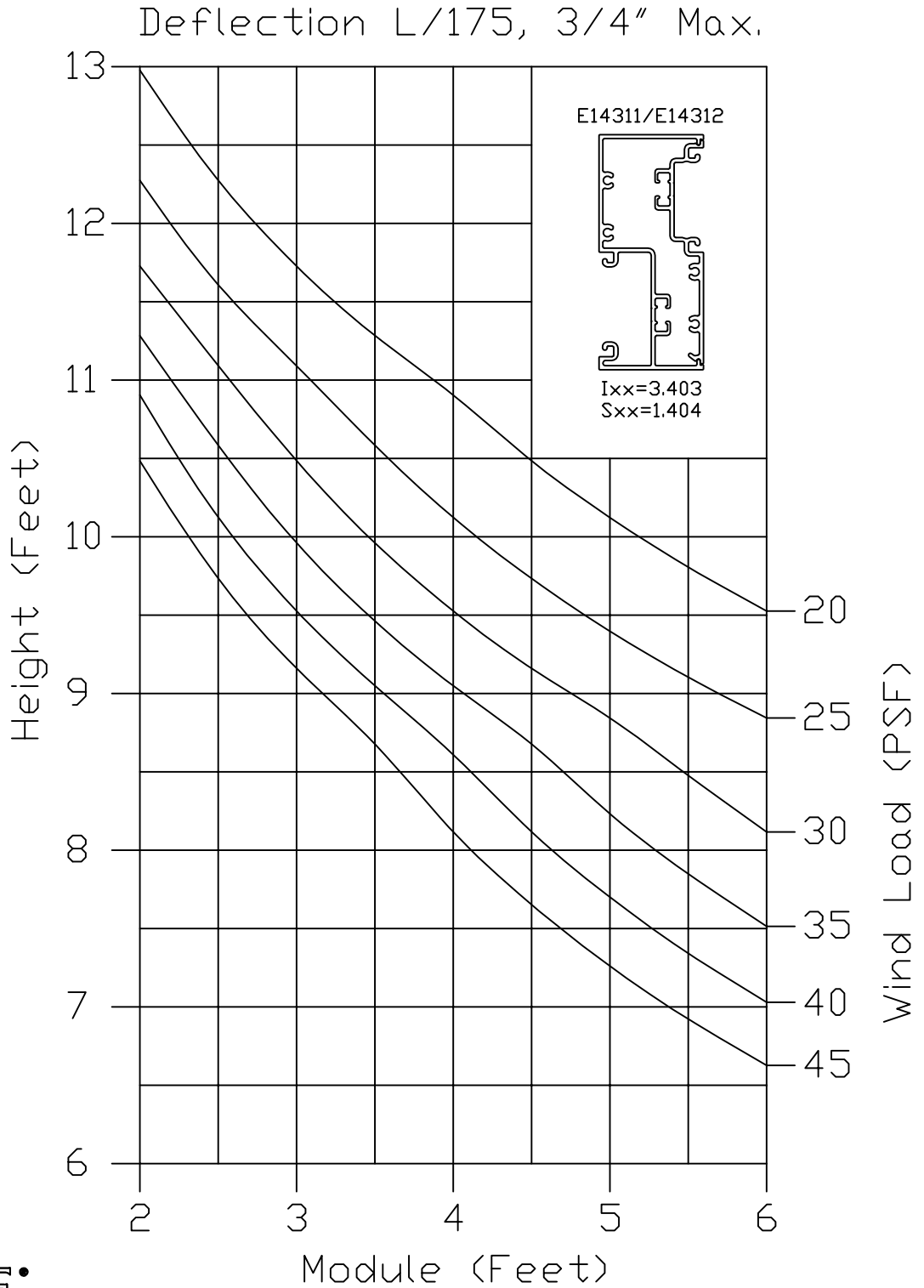

# E14000 I/O Storefront

## E14312 and E14321 Wind Load Chart

CAD DETAIL FILE NO.  
E14312 E14321 WLC

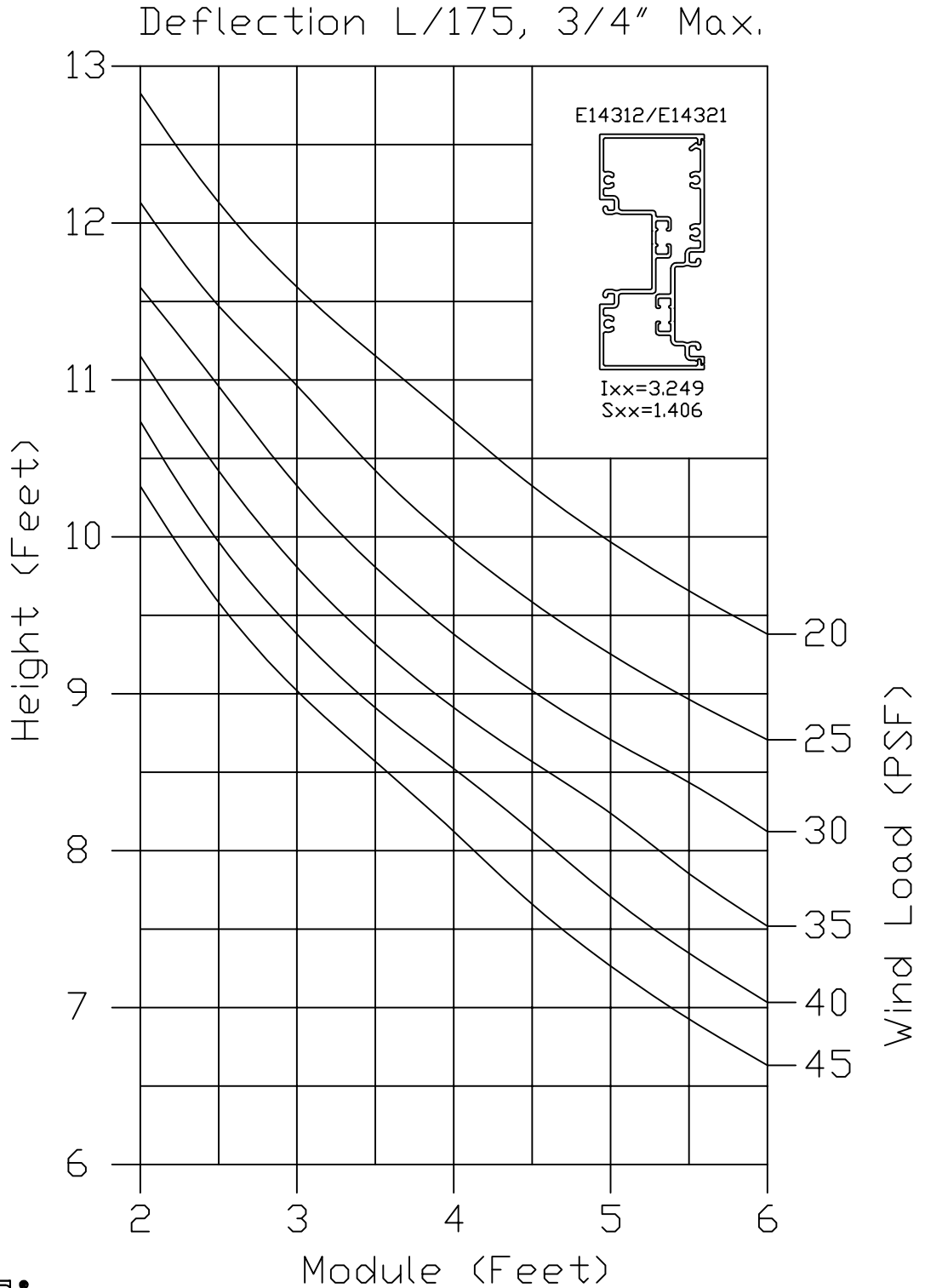

# E14000 I/O Storefront

## E14326 Wind Load Chart

CAD DETAIL FILE NO.  
E14326 WLC

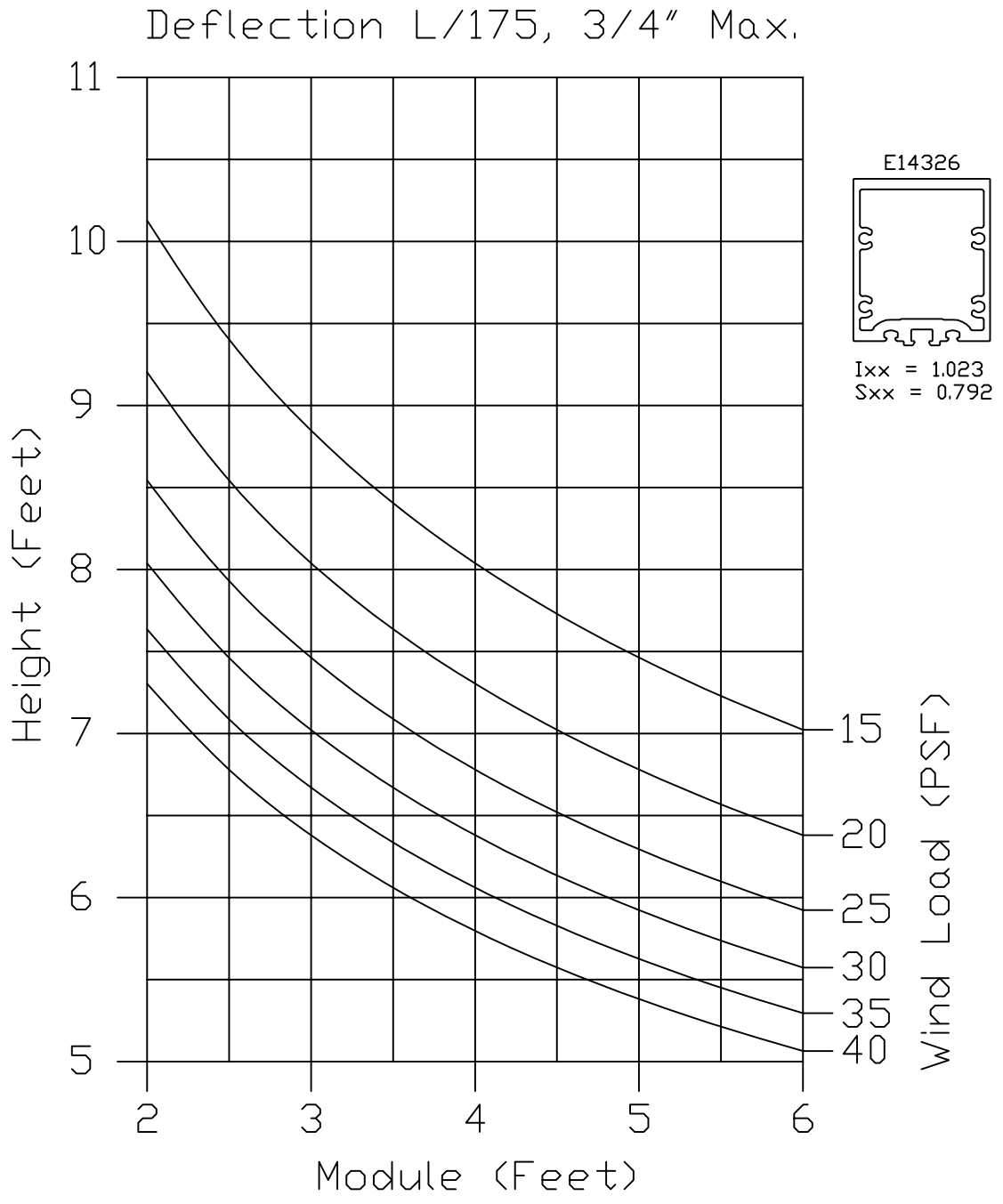



# E14000 I/O Storefront

## E14336 and E14346 Wind Load Chart

CAD DETAIL FILE NO.  
E14336 E14346 WLC

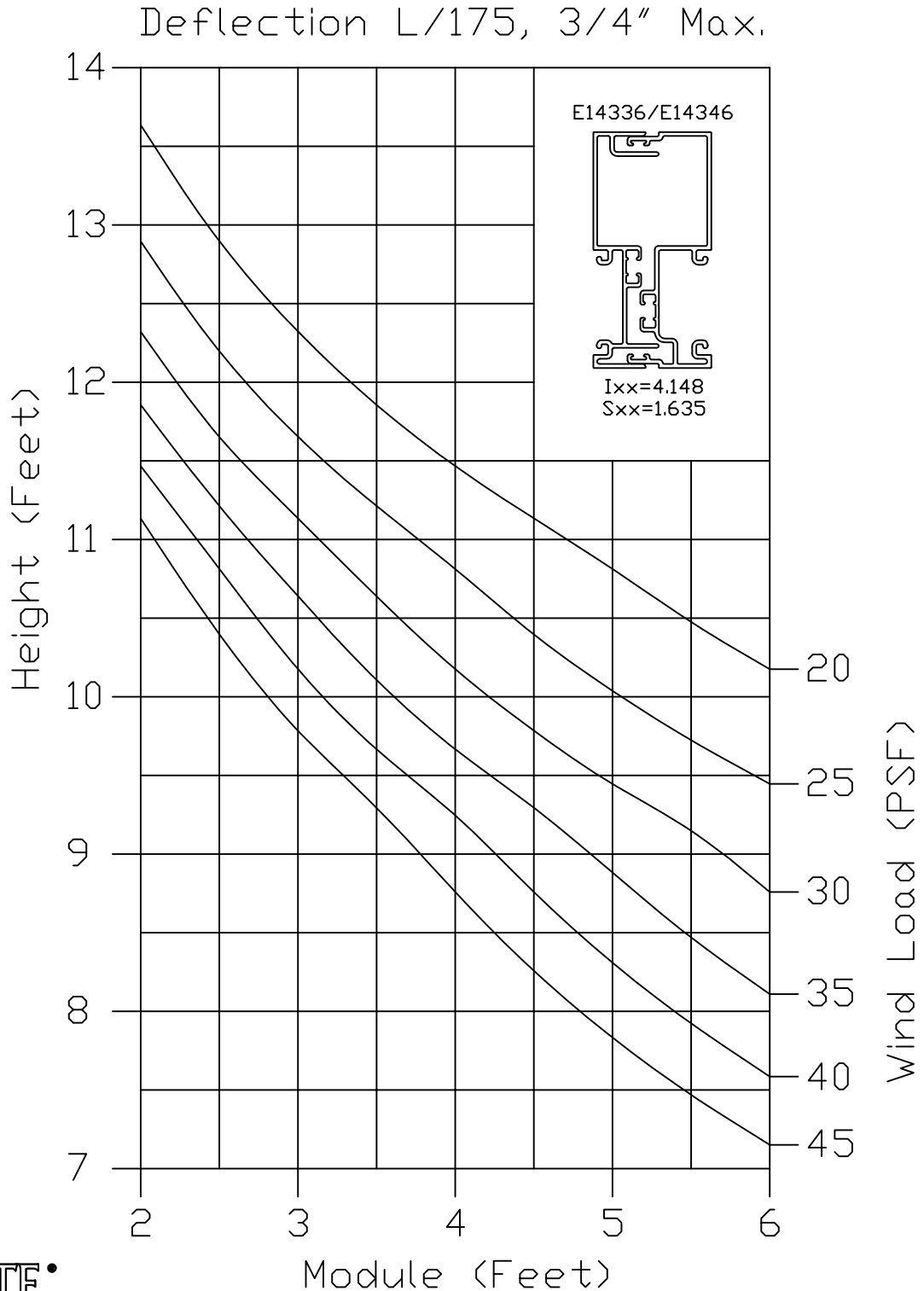

# E14000 I/O Storefront

## E14366 Wind Load Chart

CAD DETAIL FILE NO.  
E14366 WLC

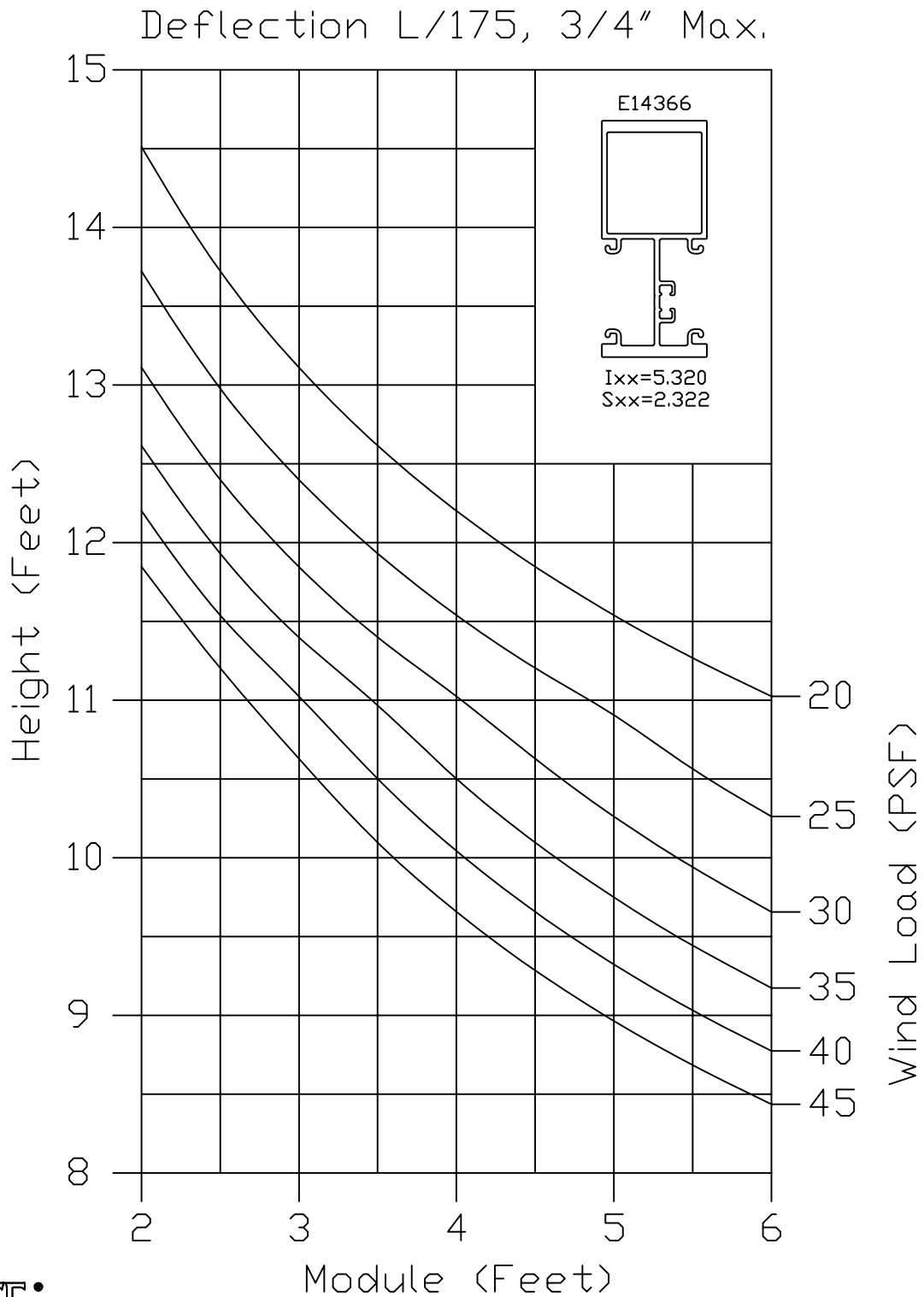

# T14000 I/O Storefront

## E14305 and T14312 Wind Load Chart

CAD DETAIL FILE NO.  
E14305 T14312 WLC

Deflection L/175, 3/4" Max.

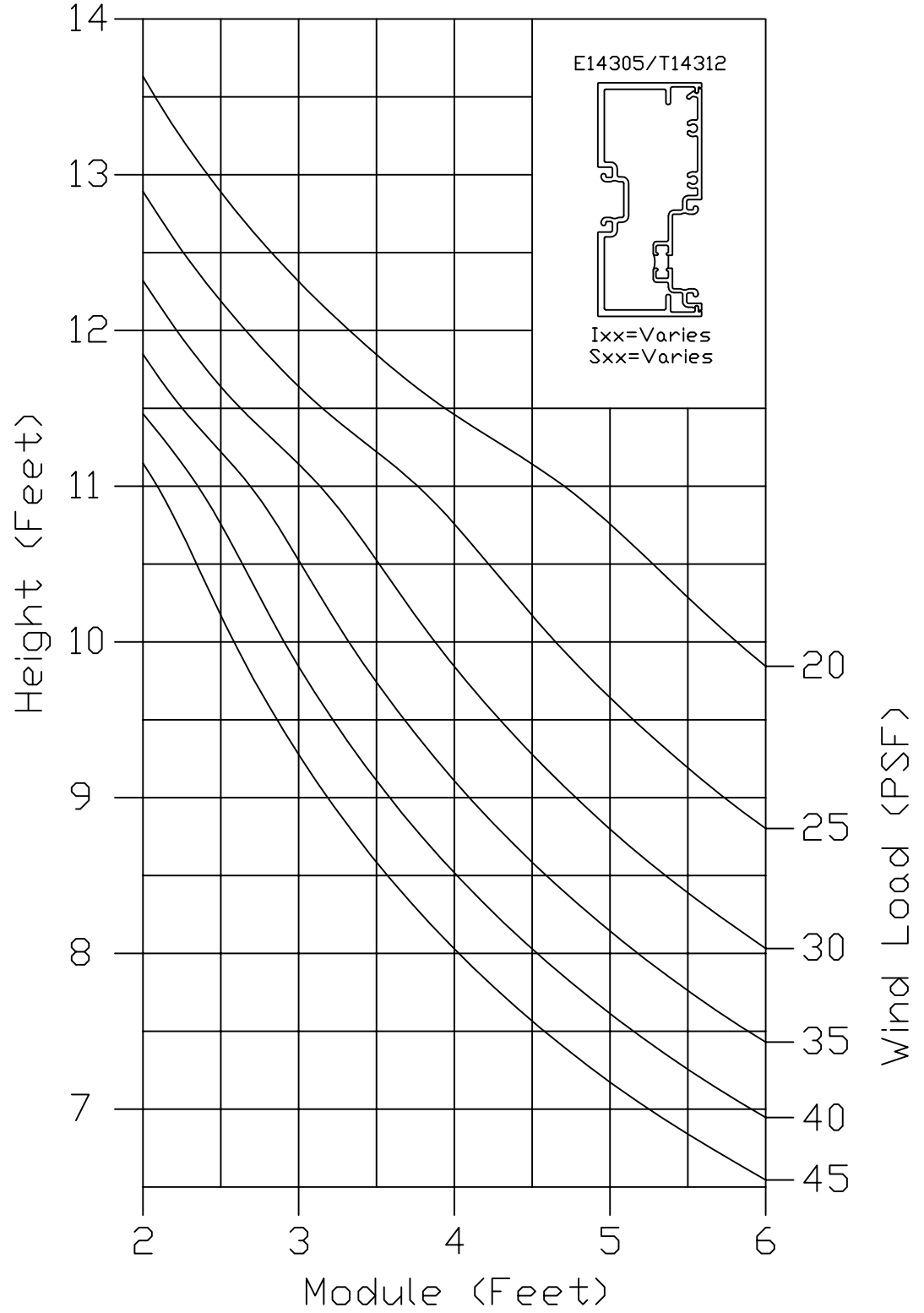

\*SEALANT, ROD, & ANCHORS NOT BY TUBELITE

# T14000 I/O Storefront

## E14305 and T14322 Wind Load Chart

CAD DETAIL FILE NO.  
E14305 T14322 WLC

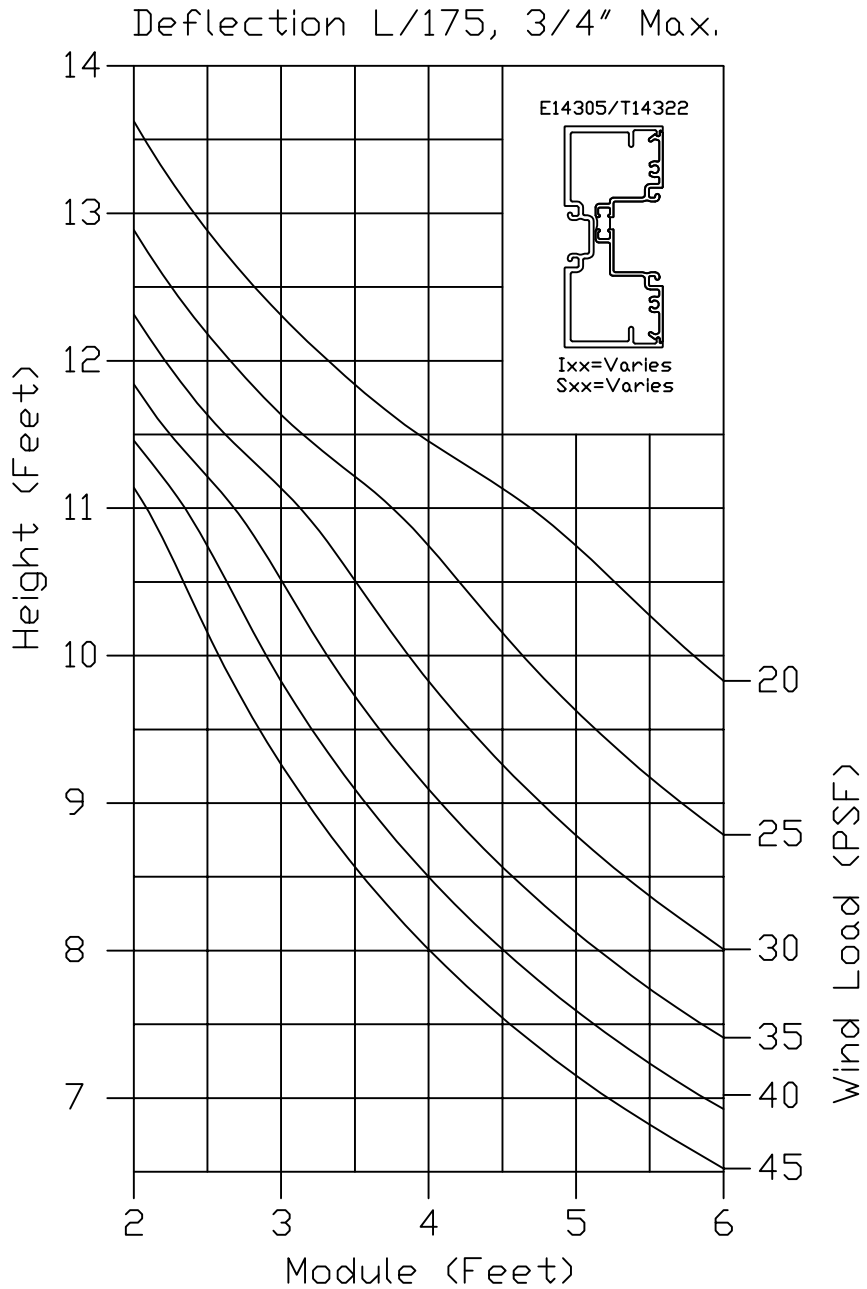

# T14000 I/O Storefront

## E14305 T14332 Wind Load Chart

CAD DETAIL FILE NO.  
E14305 T14332 WLC

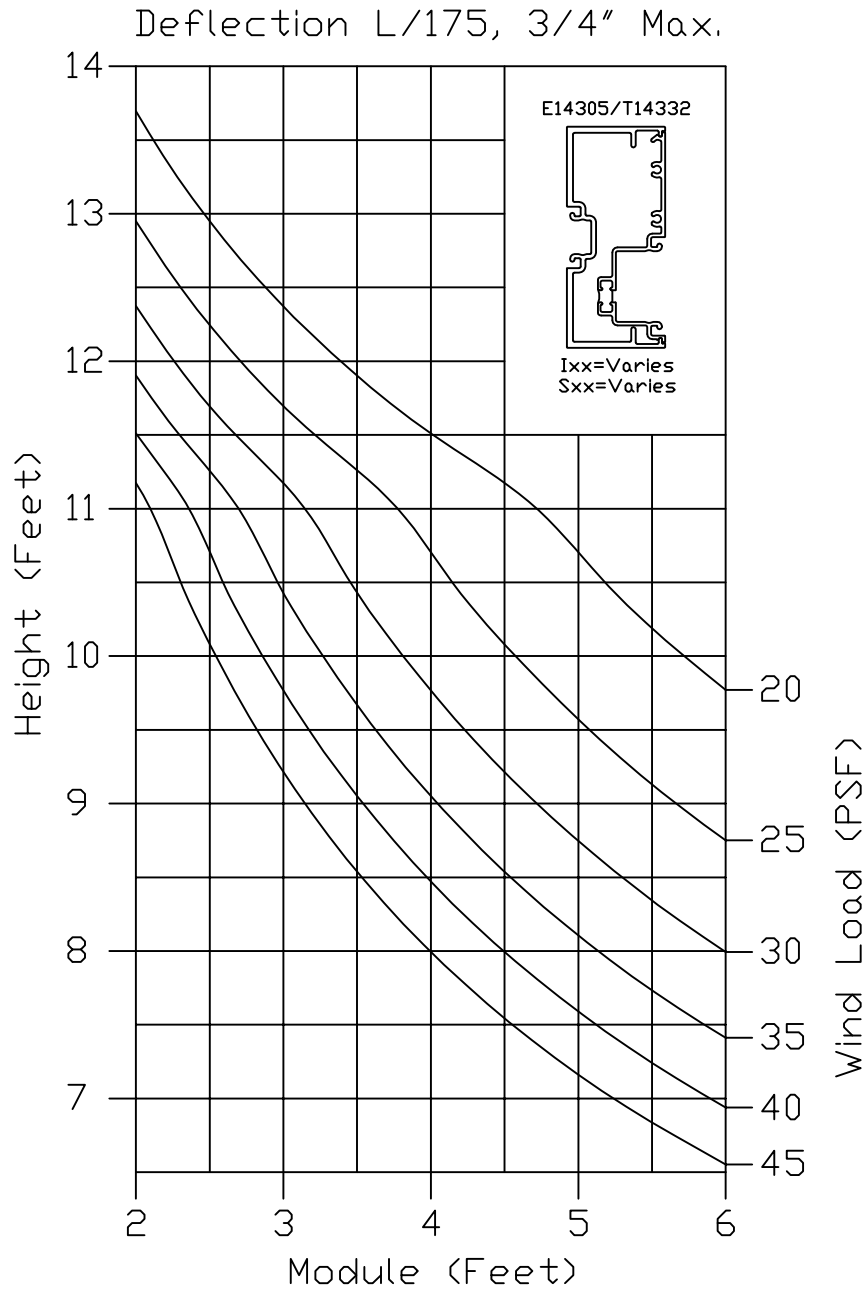

# T14000 I/O Storefront

## T14311 and T14312 Wind Load Chart

CAD DETAIL FILE NO.  
T14311 T14312 WLC

Deflection  $L/175$ , 3/4" Max.

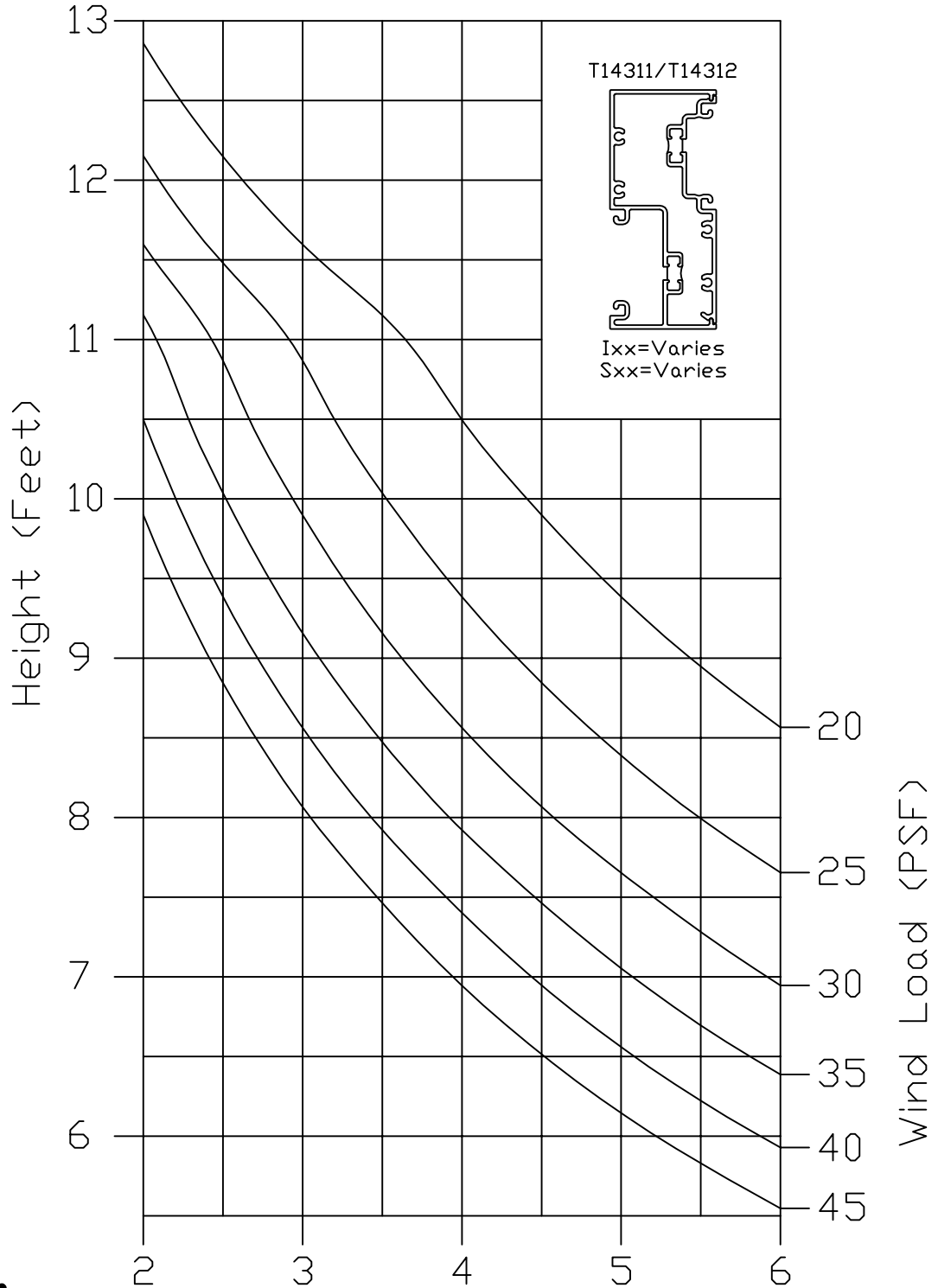

# T14000 I/O Storefront

## T14356 and E14302 Wind Load Chart

CAD DETAIL FILE NO.  
T14356 E14302 WLC

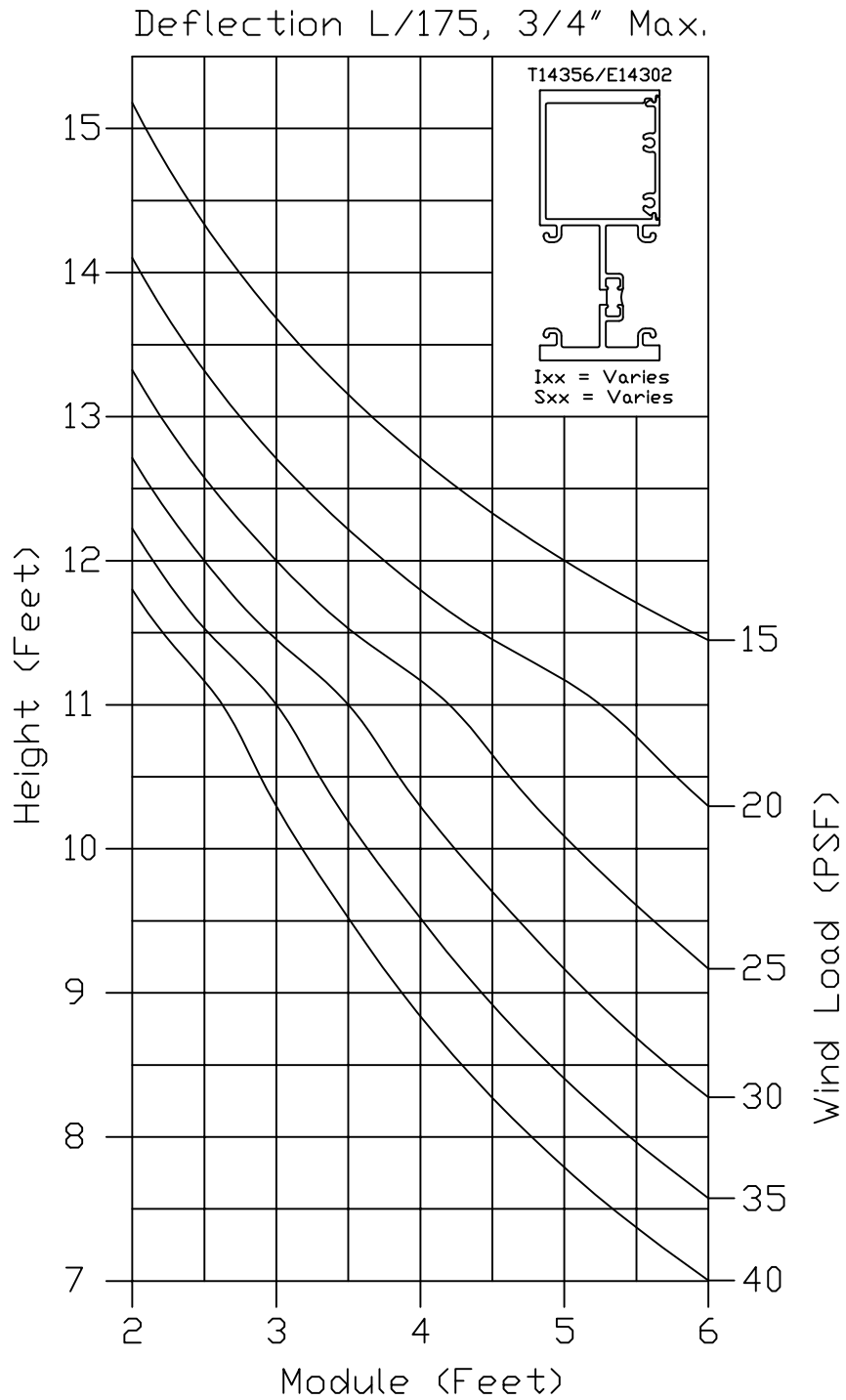

# T14000 I/O Storefront

## T14336 and T14346 Wind Load Chart

CAD DETAIL FILE NO.  
T14336 T14346 WLC

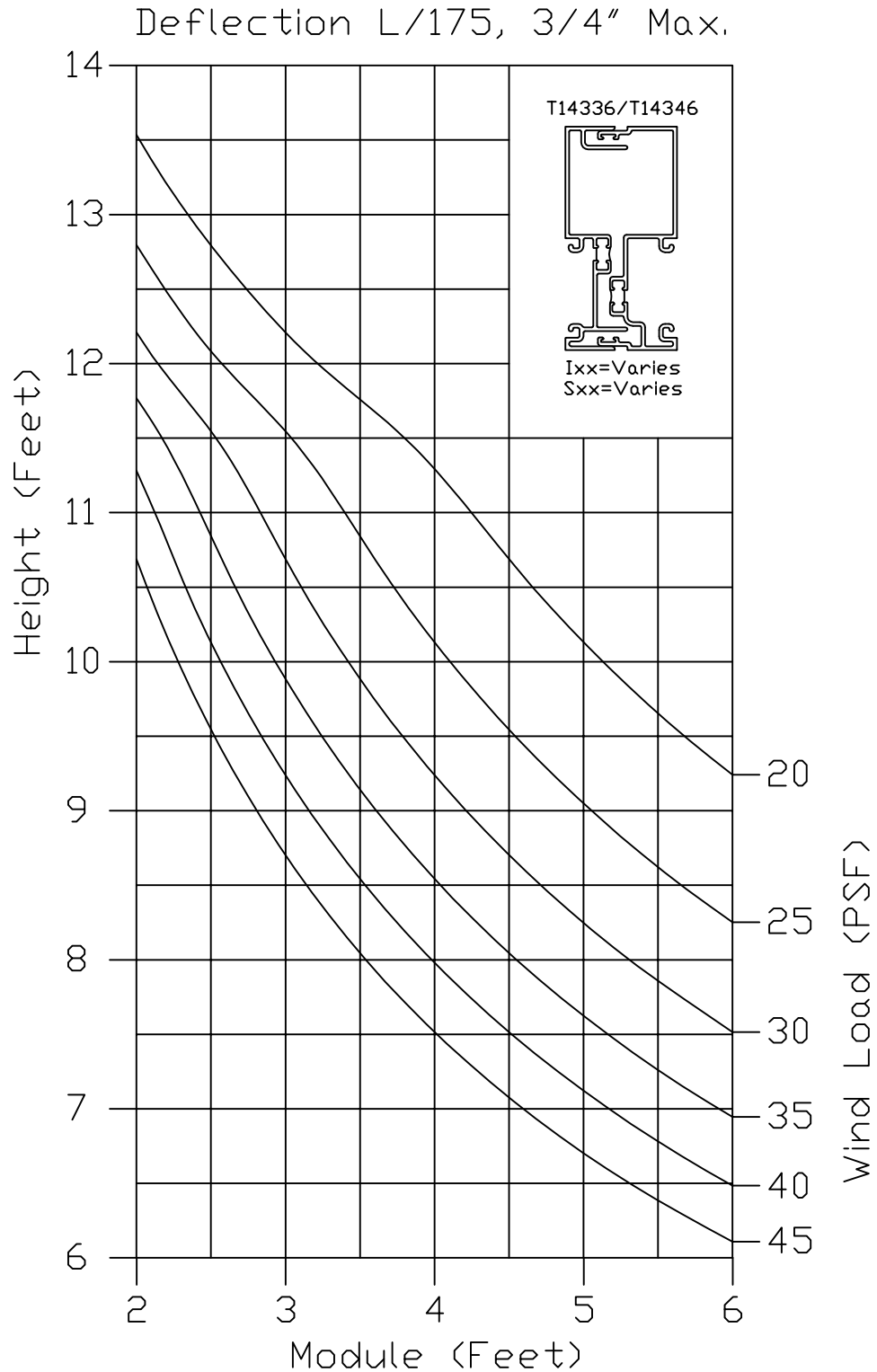



# T14000 I/O Storefront

## T14301 Wind Load Chart

CAD DETAIL FILE NO.  
T14301 WLC

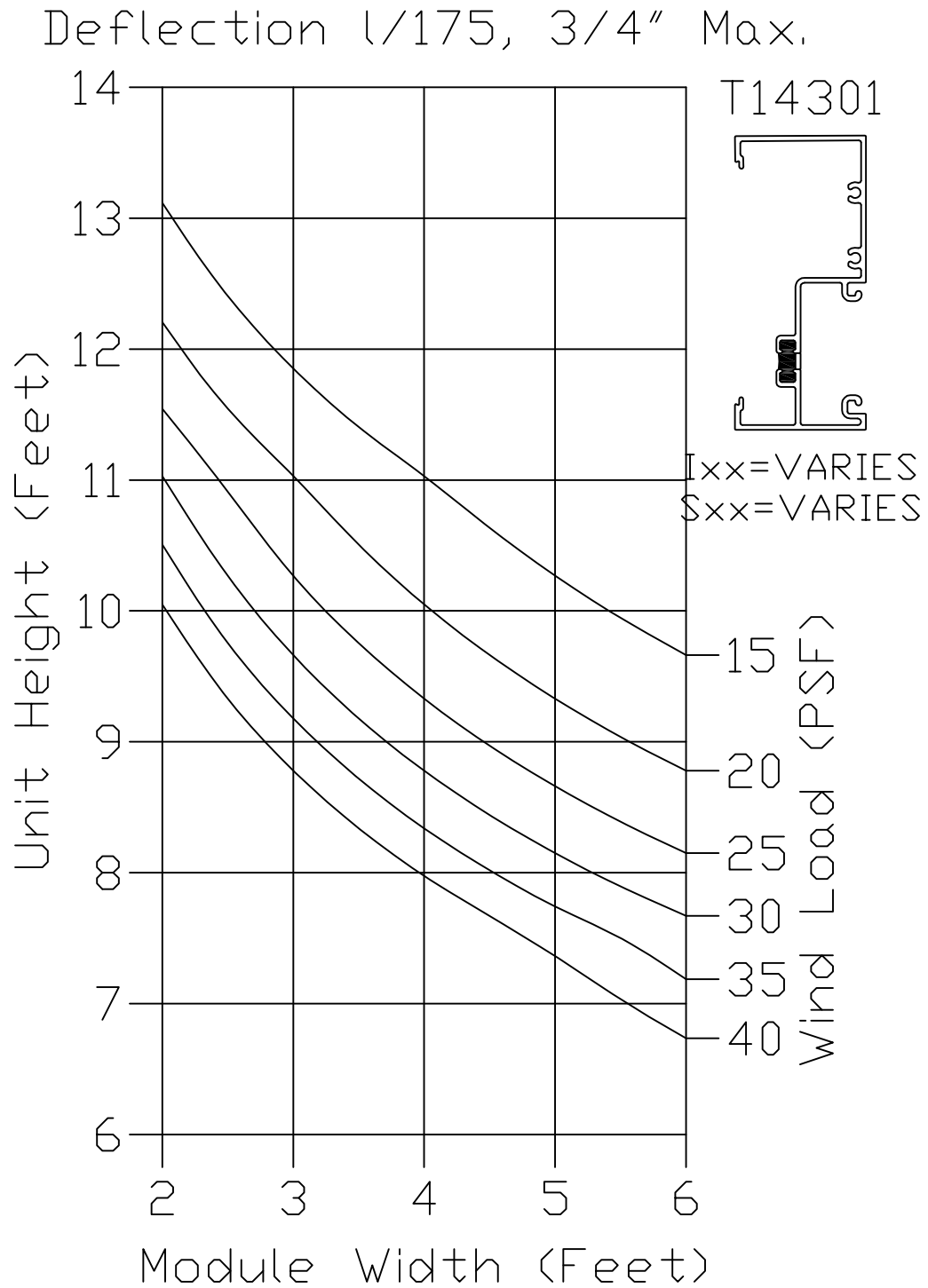

# T14000 I/O Storefront

## E14305 Wind Load Chart

CAD DETAIL FILE NO.  
E14305 WLC

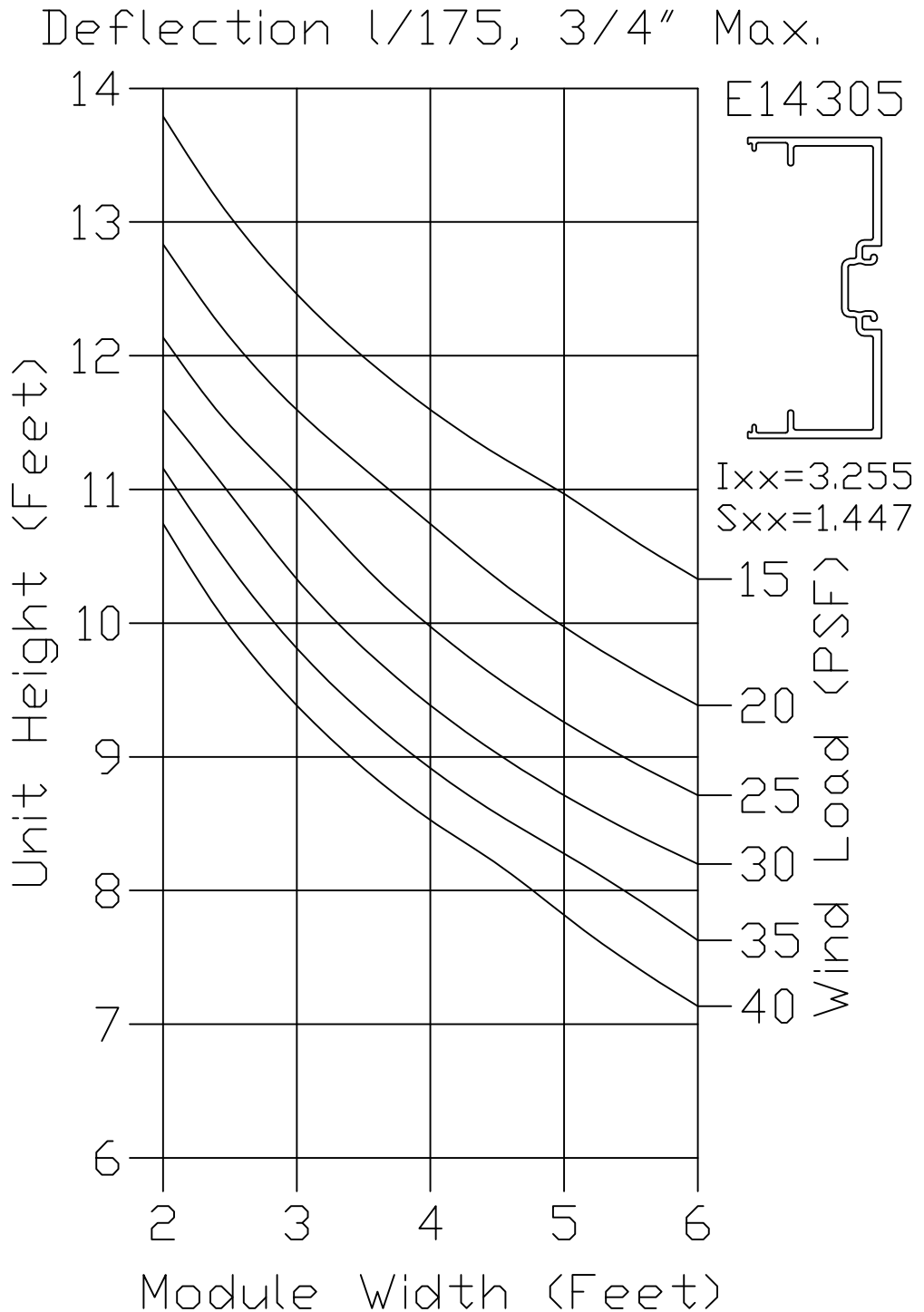

# T14000 I/O Storefront

## T14311 Wind Load Chart

CAD DETAIL FILE NO.  
T14311 WLC

